



**SUPERIOR AIRFLOW. SUPERIOR PERFORMANCE.®**



# **POWERSPORTS PRODUCTS 2016**



**STREET  
OFF-ROAD  
SNOW  
WATER**





# **2016 POWERSPORTS**

Over the last 45 years, K&N® has cemented its place within the performance aftermarket industry. K&N® prides itself in its strong ties with multiple race series, dozens of shows, as well as hundreds of sponsored top racers and test riders. Across the United States, and abroad, K&N's commitment to quality and performance is exemplified day in and day out as K&N® products are proven in real world conditions. Come see first-hand how K&N® filtration products can benefit you and your vehicle at any one of the hundreds of shows and events listed on our website at:  
[www.knfilters.com/news/events.aspx](http://www.knfilters.com/news/events.aspx)

## FOLLOW US AT:



## KNFILTERS.COM

PROUD MEMBER SINCE 1979:



The following are Trademarks and/or Registered trademarks of K&N Engineering, Inc.: K&N, the K&N Logo, Aircharger, Drycharger, Filtercharger, FIPK, FIPK Generation 2, KNFILTERS.COM, KNPOWERSPORTS.COM, Performance Gold, Precharger, Recharger, Stubstack, Typhoon, Xstream, the Xstream logo, Custom 66 Series, Powerlid, 57i, Wrench-Off Oil Filters, the Wrench-Off Oil Filter logo, High-Flow Air Filters, Power Kleen and the K&N Warranty medallions. K&N protects its marks and other legal rights against infringers.

## K&N® PRODUCT LISTINGS

<i>American V-Twin Air &amp; Oil Filter Product Listings</i> . . . . .	71
<i>Motorcycle Air &amp; Oil Filter Product Listings</i> . . . . .	85
<i>ATV Air &amp; Oil Filter Product Listings</i> . . . . .	139
<i>Specialty Air Filter and Filter Wrap Product Listings</i> . . . . .	152

## AMERICAN V-TWIN

<i>Performance Air Intake Systems*</i> . . . . .	10
<i>High-Flow Air Filters™</i> . . . . .	14

## STREET

<i>RK Series Intake Systems*</i> . . . . .	20
<i>Cruiser and Touring Air and Oil Filters</i> . . . . .	21
<i>Scooter Air and Oil Filters</i> . . . . .	23
<i>Sportbike Air and Oil Filters</i> . . . . .	24
<i>Race-Spec Racing Air Filters</i> . . . . .	25

## OFF-ROAD

<i>Off-Road Air and Oil Filters</i> . . . . .	28
<i>Motocross Xstream® Series Air Filters and Performance Oil Filters</i> . . . . .	29
<i>Minibike Air Filters</i> . . . . .	30
<i>Dirt Track Air Cleaners</i> . . . . .	31
<i>ATV / UTV Air and Oil Filters</i> . . . . .	32
<i>Side by Side Air and Oil Filters</i> . . . . .	34
<i>ATV / Side by Side Aircharger® Intake Systems*</i> . . . . .	36

## WATERCRAFT / SNOW

<i>Watercraft Flame Arrestors</i> . . . . .	40
<i>Watercraft Oil Filters</i> . . . . .	43
<i>Snowmobile Air and Oil Filters</i> . . . . .	44

## SPECIALTY / ACCESSORIES

<i>Specialty and Racing Air Filters</i> . . . . .	48
<i>Air Filter Wraps</i> . . . . .	49
<i>Vent Breathers</i> . . . . .	50
<i>Karting Air Filters</i> . . . . .	52

## HAULER HORSEPOWER

<i>Automotive High-Flow Intake Systems*</i> . . . . .	56
<i>Automotive Air and Oil Filters</i> . . . . .	60
<i>Commercial Grade Heavy Duty Air and Oil Filters</i> . . . . .	64

## APPAREL / SIGNAGE

<i>K&amp;N® Apparel</i> . . . . .	67
<i>Merchandising / Signage</i> . . . . .	68

## ADDITIONAL INFORMATION

<i>Warranties and Additional Product Information</i> . . . . .	174
<i>Cleaning Instructions and Supplies</i> . . . . .	176

\*See page 175 for specifications regarding emissions standards and CARB regulations.

# K&N® IN 1969

## WHERE IT ALL BEGAN

Ken Johnson and Norm McDonald make up the “K” and the “N” in K&N®. Ken and Norm were avid motorcycle racers who entered the aftermarket in the 1960’s with a line of motorcycle handlebars. While promoting their handlebars, Ken and Norm began experimenting with different air filter designs to combat the frustrations of the air filter technology of the day.

The problem dirt riders encountered with the paper filters used was that dirt would build up on the paper and block the flow of air to the carburetor. In addition, these paper filters were nearly impossible to clean and would usually have to be discarded after every race.

The most successful design they found consisted of layers of cotton gauze sandwiched between wire mesh. Unlike dry paper elements, they coated the cotton media with oil to act as a tacking agent to help trap dirt particles. This new technology allowed air to pass through, while still capturing dirt particles that could harm their engines.

In 1969 K&N® began production of oiled cotton gauze air filters and The World’s Best Air Filter™ was born.

Ken, Dale, and Norm



Early manufacturing facility



Norm McDonald - Acton, CA 1960

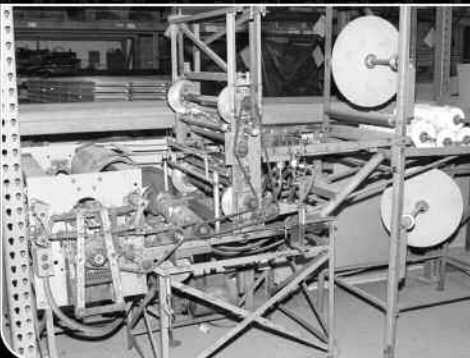

K&N's first media pleater "Plinky"



"King" Kenny Roberts - San Jose Mile 1972



Early air filter manufacturing

# K&N® TODAY

## THE PERFORMANCE AIR FILTER STANDARD

K&N® Truck and Trailer



As the originator and world leader of performance air filters, it is important to also be a leader in testing air filtration products. K&N® strives to provide a proven filtration system through our in-house test facilities. We believe our filter media provides the proper balance of airflow, protection and durability. We have advanced testing facilities that include filtration test labs, dynamometers, flowbenches, a MAF sensor test system, and many other testing machines. We put our products through extensive testing to ensure they are worthy of the name K&N®.

K&N® also employs a full staff of engineers and product designers working with the latest computer software to engineer every air filter and intake system we make. We even design and build most of the tooling and much of the machinery used to manufacture K&N® High-Flow Air Filters. With three machine shops on site, K&N® employs advanced equipment and machinery to ensure that our products are built to last. When you buy a K&N®, you can be certain we use everything we have learned to make sure our products perform their very best.



Product warehousing and processing



Automated pleating machines



Dynamometer testing



CNC filter mold fabrication



Dust retention testing

# **HIGH-FLOW AIR FILTERS™**

## **DESIGNED TO INCREASE HORSEPOWER**

K&N® delivers the same high-flow technology in every filter we manufacture. Headquartered in Riverside, California, K&N® Engineering, Inc. has been the world leader in performance filter technology since 1969. Creating a high-flow, washable and reusable air filter put K&N® on the map.

- *Designed to provide low restriction resulting in increased airflow and high performance*
- *Pleated media provides a large filtration area offering long service intervals*
- *Most are pre-oiled and ready to ride*



**WASHABLE**  
**REUSABLE**  
**PERFORMANCE®**

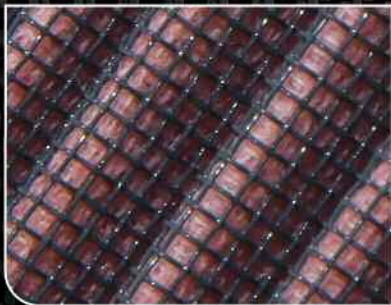

**HIGH-FLOW WASHABLE  
COTTON MEDIA**



**APPLICATION-SPECIFIC  
SEALING BEAD**



**ZINC COATED TOP PLATES  
WHERE APPLICABLE**



**DESIGNED TO FIT INTO OE  
AIR FILTER ASSEMBLIES**



**XSTREAM® SERIES AIR  
FILTER INSTALLED**



**SPECIALTY CLAMP-ON  
AIR FILTERS INSTALLED**



**1**

Oiled premium cotton gauze helps maintain high airflow and excellent filtration

- Thousands of microscopic cotton threads absorb special air filter oil, creating a powerful filter media
- Pleated design provides a large surface area for high dirt capacity and long service intervals
- Epoxy coated aluminum screen mesh protects filter media

**2**

OE style mounting tabs *(where applicable)*

**3**

One-piece seamless sealing bead ensures a precise fit

- Custom molded, application-specific air filter frame allows for easy installation *(where applicable)*



K&N® High-Flow Cotton Air Filter

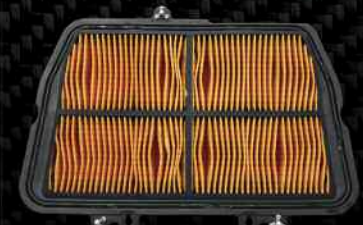

Common OE Paper Air Filter

# WRENCH-OFF® OIL FILTERS

## HIGH-FLOW PERFORMANCE FILTER MEDIA

K&N® delivers a premium oil filter built to withstand the high demands of racing conditions. Our oil filters are designed with a high-flow synthetic media that is engineered to provide high flow rates and outstanding filtration. They are ideal for use with premium synthetic and traditional oils. In order to ease maintenance, a 17mm nut has been welded to the top to allow for easy removal, especially in tight, hard to reach spaces. A heavy duty canister provides a high-burst strength while also adding extra protection from debris and rocks in off-road environments. K&N® oil filters deliver performance and confidence!

- Specially designed for today's synthetic and extended service motor oils
- Sturdy 17mm hex nut eases removal in hard to reach areas
- Ideal for hard to reach oil filters, do-it-yourself oil changes, high performance engines, and track or race applications
- K&N® limited warranty



Use of a K&N Performance Oil Filter will NOT void factory warranty.



**CARTRIDGE-STYLE OIL FILTERS ALSO AVAILABLE**



**17MM WRENCH NUT EASES REMOVAL\***



**SYNTHETIC MEDIA FOR HIGH FLOW RATES**



**PRE-DRILLED FOR SAFETY WIRE ATTACHMENT\***



**PRE-LUBED BASE SEAL FOR QUICK INSTALLATION\***



**KN-171C INSTALLED**



**KN-170 REMOVAL**

\*Where applicable



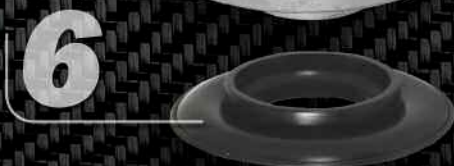
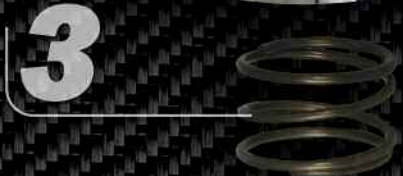

- 1** Welded 17mm hex nut for easy wrench-off® removal\*
  - Pre-drilled for safety-wire attachment during racing
- 2** Heavy duty canister construction provides a high burst strength and extra protection from debris and rocks in off-road conditions
  - Most available in black or chrome finish
- 3** Tension spring
- 4** Part number specific bypass/pressure relief valve\*
- 5** Specially designed to be compatible with premium synthetic, blended and traditional motor oils
  - Premium synthetic media provides outstanding filtration while allowing for high-flow rates
- 6** Anti-drainback valve prevents dry starts\*
- 7** Heavy duty baseplate with leakproof double-rolled seal
- 8** Pre-lubed base seal or gasket\* for easy no-mess installation

\*Where applicable



K&N® High-Flow Synthetic Media



Common Cellulose OE Replacement





# **AMERICAN V-TWIN**

## HIGH-FLOW AIR FILTERS™

- The original High-Flow Air Filter™ invented by K&N®
- Designed to provide low restriction, resulting in increased airflow and high performance
- Pleated media provides a large filtration area, delivering high capacity and long service intervals
- Specifically designed to fit into your OE air filter assembly
- Pre-oiled and ready to ride



## PERFORMANCE INTAKE SYSTEMS†

- Guaranteed to increase horsepower
- Better engine sound and power you can feel
- Replaces OE air filter assembly
- Multiple styles to choose from
- Developed around an oversized K&N® High-Flow Air Filter™
- 10-year/million mile limited warranty

WASHABLE  
REUSABLE  
PERFORMANCE®



†

SOME INTAKE SYSTEMS ARE NOT LEGAL FOR SALE OR USE ON ANY POLLUTION CONTROLLED MOTOR VEHICLE IN CALIFORNIA OR STATES ADOPTING CALIFORNIA EMISSION PROCEDURES.

See [knfilters.com](http://knfilters.com) for CARB status on each part for a specific vehicle

See page 175 for specifications regarding emissions standards and CARB regulations.

## WRENCH-OFF® OIL FILTERS

- Specially designed to be compatible with synthetic, blended and traditional motor oils
- Premium synthetic media provides outstanding filtration and high-flow rates
- Sturdy 17mm hex nut eases removal in hard to reach areas
- Heavy duty canister provides a high burst strength and extra protection
- Most Available in Black or Chrome Finish
- One-Year Limited Warranty



# AIRCHARGER® INTAKE SYSTEMS\* FOR AMERICAN V-TWINS

Custom built in the USA, providing an aggressive appearance and an increase in horsepower that you can feel!

- *Guaranteed to increase horsepower*
- *Custom aluminum throttle-body mounting plate*
- *Mandrel-bent high-flow aluminum intake tube*
- *Includes complete breather assembly and mounting hardware*
- *Available in bright mirror or textured black finish*
- *K&N® High-Flow Air Filter™ designed to increase performance*
- *10-year/million mile limited warranty*



Aircharger® Intake System installed



**AVAILABLE IN MIRROR OR  
TEXTURED BLACK FINISH**

\* NOT LEGAL FOR SALE OR USE ON ANY POLLUTION CONTROLLED MOTOR VEHICLE IN CALIFORNIA OR STATES ADOPTING CALIFORNIA EMISSION PROCEDURES.  
See [knfilters.com](http://knfilters.com) for CARB status on each part for a specific vehicle

See page 175 for specifications regarding emissions standards and CARB regulations.



**INCLUDES ALL BREATHERS  
AND HARDWARE**



**MANDREL-BENT ALUMINUM  
INTAKE TUBE**



**DRYCHARGER® FILTER  
WRAP AVAILABLE**

# RK SERIES INTAKE SYSTEMS<sup>†</sup> FOR AMERICAN V-TWINS

RK Series Intake System Installed



Fits neatly behind OE air cleaner cover to maintain a stock appearance while providing low restriction, increased performance and long service intervals.

- *Guaranteed to increase horsepower*
- *Custom aluminum backing plate provides solid mounting surface*
- *Dyno-tuned velocity stack directs airflow to engine*
- *Built-in breathers replace external OE breathers*
- *Oversized K&N® High-Flow Air Filter™ that is designed to boost performance, filtration and service intervals*
- *10-year/million mile limited warranty*

**MOST AVAILABLE WITH STANDARD OR OVERSIZED HIGH-FLOW AIR FILTER™**

**SOME INTAKE SYSTEMS ARE NOT LEGAL FOR SALE OR USE ON ANY POLLUTION CONTROLLED MOTOR VEHICLE IN CALIFORNIA OR STATES ADOPTING CALIFORNIA EMISSION PROCEDURES.**

See [knfilters.com](http://knfilters.com) for CARB status on each part for a specific vehicle

See page 175 for specifications regarding emissions standards and CARB regulations.



**INCLUDES ALL NECESSARY MOUNTING HARDWARE**



**BUILT-IN BREATHER ASSEMBLY**



**DYNO-TUNED VELOCITY STACK**

# STREET METAL™ INTAKE SYSTEMS\*

## FOR AMERICAN V-TWINS

With over 40 years of experience, K&N® is now providing custom good looks while increasing performance to your Harley-Davidson® motorcycle.

- **Guaranteed to increase horsepower**
- Aluminum backing plate with integrated velocity stack provides solid mounting surface
- Built-in breathers replace external OE breathers†
- Developed around an oversized K&N High-Flow Air Filter™ that is designed to boost performance, filtration and service intervals
- High-Quality aluminum cover with mirror finish
- Precharger® wrap available for extended service intervals†
- 10-year/million mile limited warranty

† where applicable

\*

NOT LEGAL FOR SALE OR USE ON ANY POLLUTION CONTROLLED MOTOR VEHICLE IN CALIFORNIA OR STATES ADOPTING CALIFORNIA EMISSION PROCEDURES.

See [knfilters.com](http://knfilters.com) for CARB status on each part for a specific vehicle

See page 175 for specifications regarding emissions standards and CARB regulations.

Harley-Davidson® is a registered trademark of H-D Michigan, Inc.



"Grind" Style installed



**"TORCH" STYLE**  
**6.25" HIGH**



**"FLARE" STYLE**  
**6.25" HIGH TAPERED**



**"FLUX" STYLE**  
**6.25" HIGH**



**"WELD" STYLE**  
**7.5" HIGH**



**"HAMMER" STYLE**  
**6.25" HIGH TAPERED**



**"GRIND" STYLE**  
**(EXPLODED VIEW)**  
**7.5" HIGH**

# PERFORMANCE INTAKE SYSTEMS<sup>†</sup>

## FOR AMERICAN V-TWINS

### AIR INTAKES FOR SPORTSTER® MODELS

INTAKE SYSTEM DESCRIPTION	YEARS	ENGINE (CC)	FINISH	PART #	EST. HP GAIN <sup>†</sup>	DRYCHARGER®
Aircharger®	07-16	883 (54CI)/1200 (74CI)	Mirrored	63-1126P*	+ 9 hp <sup>†</sup>	RC-3680DK
Aircharger®	07-16	883 (54CI)/1200 (74CI)	Black	63-1126*	+ 9 hp <sup>†</sup>	RC-3680DK
RK Series (Does not fit Seventy-Two®)	04-14	883 (54CI)/1200 (74CI)	•	RK-3929*	+ 4 hp <sup>†</sup> / + 8 hp <sup>†</sup>	•
Street Metal™ - Weld	91-97	1200 (74CI)	Mirrored	RK-3903*	TBA	RK-3901PK
Street Metal™ - Torch	91-97	1200 (74CI)	Mirrored	RK-3904*	TBA	RK-3902PK
Street Metal™ - Grind	91-97	1200 (74CI)	Ball Grooved	RK-3913*	TBA	RK-3901PK
Street Metal™ - Flux	91-97	1200 (74CI)	Ball Grooved	RK-3914*	TBA	RK-3902PK

### AIR INTAKES FOR DYNA® AND SOFTAIL® MODELS

INTAKE SYSTEM DESCRIPTION	YEARS	ENGINE (CI)	FINISH	PART #	EST. HP GAIN <sup>†</sup>	DRYCHARGER®
Aircharger®	08-15	96/103	Mirrored	63-1125P*	+ 10 hp <sup>†</sup>	RC-3680DK
Aircharger®	08-15	96/103	Black	63-1125*	+ 10 hp <sup>†</sup>	RC-3680DK
Street Metal™ - Flare	08-16	96/103	Mirrored	RK-3932*	+ 10 hp <sup>†</sup>	•
Street Metal™ - Hammer	08-16	96/103	Mirrored	RK-3933*	+ 10 hp <sup>†</sup>	HD-0800DK
Street Metal™ - Weld	08-16	96/103	Mirrored	RK-3934*	+ 10 hp <sup>†</sup>	RK-3901PK
Street Metal™ - Torch	08-16	96/103	Mirrored	RK-3935*	+ 12 hp <sup>†</sup>	RK-3902PK
RK Series (Does not fit Softail® or 2013+ Street Bob®)	08-16	96/103	•	RK-3931*	+ 7 hp <sup>†</sup>	•
RK Series (Softail® only)	13-15	96/103	•	RK-3942*	+ 9 hp <sup>†</sup>	•
RK Series - 1 5/8" Standard Height (Softail® only)	08-12	96/103	•	RK-3909-1*	+ 10 hp <sup>†</sup>	•
RK Series - 2 1/4" Large Capacity (Softail® only)	08-12	96/103	•	RK-3910-1*	+ 11 hp <sup>†</sup>	•
Aircharger®	99-07	88/96 F/I	Mirrored	63-1125P*	+ 8 hp <sup>†</sup>	RC-3680DK
Aircharger®	99-07	88/96 F/I	Black	63-1125*	+ 8 hp <sup>†</sup>	RC-3680DK
RK Series - 1 5/8" Standard Height	01-07	88/96 F/I	•	RK-3909-1 <sup>†</sup>	+ 6 hp <sup>†</sup>	•
RK Series - 2 1/4" Large Capacity	01-07	88/96 F/I	•	RK-3910-1 <sup>†</sup>	+ 11 hp <sup>†</sup>	•
RK Series - 1 5/8" Standard Height	99-06	88/96	•	RK-3909-1*	+ 6 hp <sup>†</sup>	•
RK Series - 2 1/4" Large Capacity	99-06	88/96	•	RK-3910-1*	+ 11 hp <sup>†</sup>	•
Street Metal™ - Flare	99-07	88/96 F/I	Mirrored	RK-3932*	+ 7 hp <sup>†</sup>	•
Street Metal™ - Hammer	99-07	88/96 F/I	Mirrored	RK-3933*	+ 7 hp <sup>†</sup>	HD-0800DK
Street Metal™ - Weld	99-07	88/96 F/I	Mirrored	RK-3934*	+ 10 hp <sup>†</sup>	RK-3901PK
Street Metal™ - Torch	99-07	88/96 F/I	Mirrored	RK-3935*	+ 12 hp <sup>†</sup>	RK-3902PK
Street Metal™ - Weld	92-97	82	Mirrored	RK-3901*	TBA	RK-3901PK
Street Metal™ - Torch	92-97	82	Mirrored	RK-3902*	TBA	RK-3902PK
Street Metal™ - Grind	92-97	82	Ball Grooved	RK-3911*	TBA	RK-3901PK
Street Metal™ - Flux	92-97	82	Ball Grooved	RK-3912*	TBA	RK-3902PK

### AIR INTAKES FOR TOURING MODELS

INTAKE SYSTEM DESCRIPTION	YEARS	ENGINE (CI)	FINISH	PART #	EST. HP GAIN <sup>†</sup>	DRYCHARGER®
Aircharger® (Does not fit models with lower fairings)	08-16	96/103	Mirrored	63-1122P*	+ 13 hp <sup>†</sup>	RC-3680DK
Aircharger® (Does not fit models with lower fairings)	08-16	96/103	Black	63-1122*	+ 13 hp <sup>†</sup>	RC-3680DK
RK Series - 1 5/8" Standard Height	08-13	96/103	•	RK-3930*	+ 8 hp <sup>†</sup>	•
RK Series - 1 5/8" Standard Height	14-15	103/110	•	RK-3941*	TBA	•
Large Capacity Filter Kit (fits RK-3930/RK-3909-1)	•	•	•	RT-3910	•	•
Street Metal™ - Grind	08-16	96/103	Ball Grooved	RK-3936*	+ 10 hp <sup>†</sup>	RK-3902PK
Street Metal™ - Flux	08-16	96/103	Ball Grooved	RK-3937*	+ 10 hp <sup>†</sup>	RK-3902PK
Street Metal™ - Weld	08-16	96/103	Mirrored	RK-3938*	+ 10 hp <sup>†</sup>	RK-3901PK
Street Metal™ - Torch	08-16	96/103	Mirrored	RK-3939*	+ 10 hp <sup>†</sup>	RK-3901PK
Aircharger®	01-07	88/96 F/I	Mirrored	63-1125P*	+ 8 hp <sup>†</sup>	RC-3680DK
Aircharger®	01-07	88/96 F/I	Black	63-1125*	+ 8 hp <sup>†</sup>	RC-3680DK
Street Metal™ - Flare	01-07	88/96 F/I	Mirrored	RK-3932*	+ 7 hp <sup>†</sup>	•
Street Metal™ - Hammer	01-07	88/96 F/I	Mirrored	RK-3933*	+ 7 hp <sup>†</sup>	HD-0800DK
Street Metal™ - Weld	01-07	88/96 F/I	Mirrored	RK-3934*	+ 10 hp <sup>†</sup>	RK-3901PK
Street Metal™ - Torch	01-07	88/96 F/I	Mirrored	RK-3935*	+ 12 hp <sup>†</sup>	RK-3902PK
RK Series - 1 5/8" Standard Height	01-07	88/96 F/I	•	RK-3909-1 <sup>†</sup>	+ 6 hp <sup>†</sup>	•
RK Series - 2 1/4" Large Capacity	01-07	88/96 F/I	•	RK-3910-1 <sup>†</sup>	+ 11 hp <sup>†</sup>	•
RK Series - 1 5/8" Standard Height	99-06	88/96	•	RK-3909-1*	+ 6 hp <sup>†</sup>	•
RK Series - 2 1/4" Large Capacity	99-06	88/96	•	RK-3910-1*	+ 11 hp <sup>†</sup>	•
Street Metal™ - Weld	92-97	82	Mirrored	RK-3901*	TBA	RK-3901PK
Street Metal™ - Torch	92-97	82	Mirrored	RK-3902*	TBA	RK-3902PK
Street Metal™ - Grind	92-97	82	Ball Grooved	RK-3911*	TBA	RK-3901PK
Street Metal™ - Flux	92-97	82	Ball Grooved	RK-3912*	TBA	RK-3902PK

1) 50 state street legal \*Not legal for sale or use on any pollution controlled motor vehicle in California or states adopting California emission procedures.  
<sup>†</sup>Estimated horsepower and torque gains based on specific or similar vehicle dynamometer tests. Results will vary. See page 175 for specifications regarding emissions standards and CARB regulations and additional testing and estimated horsepower information.

Dyna®, Sportster®, Seventy-Two®, Street Bob® and Softail® are trademarks of Harley-Davidson®. Harley-Davidson® is a registered trademark of H-D Michigan, Inc.

Parts Updated Daily at [KNFILTERS.COM](http://KNFILTERS.COM) or Call 800-858-3333

# AIR FILTER ASSEMBLIES FOR AMERICAN V-TWINS

Designed to provide era specific good looks to your vintage restoration or to customize your latest bobber project.

- Multiple size and dimensions to fit different carburetors and adaptors
- Chrome-plated top or more protective bonnet to protect from the elements



RK-3201 Installed



\* NOT LEGAL FOR SALE OR USE ON ANY POLLUTION CONTROLLED MOTOR VEHICLE IN CALIFORNIA OR STATES ADOPTING CALIFORNIA EMISSION PROCEDURES.

See knfilters.com for CARB status on each part for a specific vehicle

See page 175 for specifications regarding emissions standards and CARB regulations.

## CHROME BONNET CLOSED ROUND AIR CLEANER ASSEMBLIES

DESCRIPTION	O.D.	HEIGHT	FLANGE	PART#
Keihin 6" diameter chrome bonnet w/ air filter	4 1/2" B - 5 1/2" T	2"	5/8" L	<b>RK-380B</b>
Replacement element for RK-380B	4 1/2" B - 5 1/2" T	2"	5/8" L	<b>RK-380E</b>
Mikuni 36-38mm 6" diameter chrome bonnet w/ air filter	5 1/4" B - 5 1/2" T	1 7/8"	5/8" L	<b>ML-085B<sup>1</sup></b>
Replacement element for ML-085B	5 1/4" B - 5 1/2" T	1 7/8"	5/8" L	<b>ML-0850<sup>1</sup></b>
Mikuni 40-45mm 6" diameter chrome bonnet w/ air filter	5 1/4" B - 5 1/2" T	1 7/8"	5/8" L	<b>ML-092B<sup>3</sup></b>
Replacement element for ML-092B	5 1/4" B - 5 1/2" T	1 7/8"	5/8" L	<b>ML-0920<sup>3</sup></b>

PART NUMBER  
RK-380E



## CHROME-TOP OPEN ROUND AIR CLEANER ASSEMBLIES

DESCRIPTION	O.D.	I.D.	HEIGHT	PART#
S&S chrome-top open round air filter	5 1/4"	4"	2"	<b>RK-3201<sup>4</sup></b>
Keihin chrome-top open round air filter	5 1/4"	4"	2"	<b>RK-3201</b>
Mikuni 36-38mm chrome-top open round air filter	5 1/8"	2"	5/8"	<b>RC-0850<sup>1</sup></b>
Mikuni 40-45mm chrome-top open round air filter	5"	2"	5/8"	<b>RC-0920<sup>3</sup></b>

PART NUMBER  
RC-0920

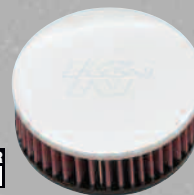

## CHROME BONNET OPEN ROUND AIR CLEANER ASSEMBLIES

DESCRIPTION	O.D.	I.D.	HEIGHT	PART#
S&S 6" diameter chrome bonnet with air filter	5 1/4"	4"	2"	<b>RK-320B<sup>4</sup></b>
Keihin 6" diameter chrome bonnet with air filter	5 1/4"	4"	2"	<b>RK-320B</b>
Bendix-Tillotson 6" diameter chrome bonnet with air filter	5 1/4"	4"	2"	<b>RT-320B</b>
Replacement element for RT-320B	5 1/4"	4"	2"	<b>E-3200</b>
Linkert 6" diameter chrome bonnet with air filter	5 1/4"	4"	2"	<b>RL-320B</b>
Replacement element for RL-320B	5 1/4"	4"	2"	<b>E-3200</b>
Replacement element for RK-320B	5 1/4"	4"	2"	<b>E-3200</b>

PART NUMBER  
RK-320B



PART NUMBER  
RC-2000



## CHROME-TOP OPEN OVAL AIR CLEANER ASSEMBLIES

DESCRIPTION	O.D.	HEIGHT	FLANGE	PART#
Mikuni 36-38mm chrome-top open oval air filter	7" x 4 1/2"	2"	5/8" L	<b>RC-1980<sup>1</sup></b>
Mikuni 40-45mm chrome-top open oval air filter	7" x 4 1/2"	2"	5/8" L	<b>RC-2000<sup>3</sup></b>

PART NUMBER  
RC-0920

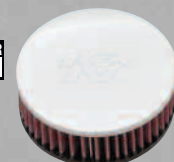

## CHROME-TOP OPEN ROUND AIR CLEANER ASSEMBLIES

DESCRIPTION	O.D.	HEIGHT	FLANGE	PART#
Keihin Flowmaster chrome-top open round air filter	4 1/2" B - 5 1/2" T	2"	5/8" L	<b>RK-3800<sup>2</sup></b>
Mikuni chrome-top open round air filter	5" B - 5" T	2"	5/8" L	<b>RC-0920<sup>3</sup></b>

Air Cleaners mount directly to carburetor flange 1) Uses 2 7/16" mounting flange 2) Uses 2 5/8" mounting flange 3) Uses 2 3/4" mounting flange 4) Carburetors 1976 & up, excluding All S&S E & G carburetors. K&N® custom air cleaners were designed to fit American v-twin motorcycles equipped with various carburetors and to increase horsepower with proper carburetor calibration.



# HIGH-FLOW AIR FILTERS™ FOR AMERICAN V-TWINS

RE-0960 Installed on K&N® Aircharger®



K&N® manufactures a wide variety of replacement High-Flow Air Filters™ that are not motorcycle specific.

- Designed to fit into your aftermarket air filter assembly
- Designed to provide low restriction, resulting in increased air-flow and high-performance

PART NUMBER  
RE-0960

PART NUMBER  
RC-3680



## REPLACEMENT ELEMENT FOR ELBOW-STYLE INTAKE SYSTEMS

DESCRIPTION	SHAPE	FLANGE SIZE	TOP DIA.	BASE DIA.	HEIGHT	FINISH	PART#	DRYCHARGER®
High-Flow Air Filter	Oval Tapered	2-7/16"	4-1/2"	3"	6"	Chrome	RC-3680	RC-3680DK
High-Flow Air Filter	Oval Tapered	2-7/16"	4-1/2"	3-1/2"	6"	Black	RE-0960	RC-3680DK
High-Flow Air Filter	Round Tapered	2-1/2"	4-1/2"	3-1/2"	5"	Chrome	RC-9630	RC-9350DK

## HIGH-FLOW AIR FILTERS™ - FOR OTHER MODELS

### FOR S&S MODELS

	O.D.	HEIGHT	PART#
"D" teardrop housing	6"	2-1/16"	E-3224
Teardrop shaped housing	6"	2-3/16"	E-3225
"E" & "G" teardrop housing	6"	2-1/2"	E-3226

### FOR INDIAN MODELS

	YEAR	O.D.	I.D.	HEIGHT	PART#
Chief Classic	2014	•	•	•	PL-1814
Chief	09-13	6 1/4"	5 1/4"	1 1/2"	E-3290
Chief	02-03	6 3/8"	5"	1 5/8"	E-3981
Chief	99-00	6"	4 5/8"	2 3/4"	E-3971 <sup>3</sup>
Scout	15-16	•	•	•	PL-1115
Scout/Spirit	01-03	6"	4 5/8"	2 3/4"	E-3971 <sup>3</sup>

(Fits stock S&S teardrop back and Indian teardrop cover)

### FOR SCREAMIN' EAGLE® MODELS

	TOP O.D.	BASE O.D.	HEIGHT	PART#
Evolution® air cleaner - reverse tapered	•	•	2-3/4"	E-3227
Evolution® air cleaner - reverse tapered	•	•	3-1/4"	E-3228
Twin Cam® air cleaner - reverse tapered	•	•	3-1/4"	HD-0700
Eagle Iron Teardrop replacement air filter	•	6"	2-1/4"	HD-0500

### FOR REVTECH® MODELS

	O.D.	HEIGHT	PART#
Early style RevTech® with top plate	7"	1.975"	HD-0600
Late style RevTech®	7"	2"	E-4660

(Early to late style 88" and 100" engines)

### FOR VICTORY MODELS

	YEAR	STYLE	PART#
Victory Hammer/Highball/Kingpin/Vegas/Judge	08-15	Panel	PL-1608
Victory Gunner	2015	Panel	PL-1608
Victory V92SC/Hammer/Jackpot/Kingpin/Touring/Vegas	00-07	Panel	PL-1500
Victory V92C	98-99	Cone	PL-1598

Twin Cam®, Evolution®, and Screamin' Eagle® are trademarks of Harley-Davidson®. Harley-Davidson® is a registered trademark of H-D Michigan, Inc. K&N® custom air cleaners were designed to fit American v-twin motorcycles equipped with various carburetors and to increase horsepower with proper carburetor calibration.

PART NUMBER  
E-3225



PART NUMBER  
PL-1115



PART NUMBER  
E-3228



PART NUMBER  
E-4660



PART NUMBER  
PL-1608

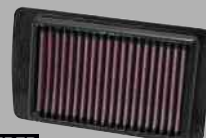

AMERICAN  
V-TWIN

STREET

OFF-ROAD

WATERCRAFT/SNOW

SPECIALTY/ACCESSORIES

HAULER HORSEPOWER

APPAREL/SIGNAGE

K&N® PRODUCT LISTINGS

# HIGH-FLOW AIR FILTERS™

## FOR AMERICAN V-TWINS

### AIR FILTERS FOR SPORTSTER® MODELS

#### OE REPLACEMENT AIR FILTER FOR 2004-15 SPORTSTER®

DESCRIPTION	PART#
Replaces OE# 29331-04 For 2004-2013 Sportster® Except XL-1200V 72	HD-8834
Replaces OE# 294000-15 For 2012-2016 XL-1200V Sportster® 72 & 2014-2015 Sportster®	HD-1212

PART NUMBER  
HD-8834



PART NUMBER  
HD-1212

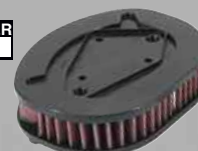

#### REPLACEMENT AIR FILTER FOR 2004-15 SPORTSTER® SCREAMIN' EAGLE®

DESCRIPTION	PART#	DRYCHARGER®
Replaces Screamin' Eagle® # 29442-99E	HD-0800	HD-0800DK
Replaces Screamin' Eagle® # 29044-04B	HD-0900	.

#### HD-0900:

- 9 3/8" L X 6" W Oval X 1 7/8" H
- Top plate fits standard mounting pattern for Sportster® Screamin' Eagle® air cleaners



PART NUMBER  
HD-0900

### AIR FILTERS FOR DYNA® MODELS

#### OE REPLACEMENT AIR FILTER FOR 2008-16 DYNA® MODELS

DESCRIPTION	PART#
Replaces OE# 29191-08 Except 2013+ Dyna Street Bob	HD-9608

PART NUMBER  
HD-9608



#### REPLACEMENT AIR FILTER FOR 2008-15 DYNA® SCREAMIN' EAGLE®

DESCRIPTION	PART#
Replaces Screamin' Eagle® # 29385-08	HD-0808

PART NUMBER  
HD-0808



- Unique tear drop metal top plate with centered 5/16" NC weld nut to attach cover
- Three-hole-drilled to fit standard mounting pattern for Dyna® Screamin' Eagle® backplate
- Teardrop molded rubber base

### AIR FILTERS FOR TWIN CAM® AND SOFTAIL® MODELS

#### REPLACEMENT AIR FILTER FOR 1999-07 TWIN CAM® & 2008-15 SOFTAIL® MODELS

DESCRIPTION	PART#
Replaces OE# 29461-99 (most 99-07 Twin Cam® and 99-15 Softail® models)	HD-1499
Replaces OE# 29462-99 (99-01 F/I Twin Cam® models)	HD-8899
Replaces OE# 29314-08 (Cross Bones™/Blackline®/Softail Slim®)	HD-1611

PART NUMBER  
HD-1499



PART NUMBER  
HD-8899



PART NUMBER  
HD-1611



#### REPLACEMENT AIR FILTER (TAPERED) FOR MOST 1999-07 TWIN CAM® SCREAMIN' EAGLE®

DESCRIPTION	PART#	DRYCHARGER®
Replaces Screamin' Eagle® part numbers 29442-99A, 29442-99B, 29442-99C, 29442-99D & 29442-99E	HD-0800	HD-0800DK

- 5 1/2" diameter metal top plate has centered 5/16" NC weld nut to attach stock cover
- Top plate is three-hole drilled to fit standard mounting pattern for Twin Cam® air cleaners
- 6 1/4" diameter molded rubber base



PART NUMBER  
HD-0800

Screamin' Eagle®, Dyna®, Softail®, Cross Bones™, Blackline®, Softail Slim®, Twin Cam®, and Sportster® are trademarks of Harley-Davidson®. Harley-Davidson® is a registered trademark of H-D Michigan, Inc.

# HIGH-FLOW AIR FILTERS™ FOR AMERICAN V-TWINS

## AIR FILTERS FOR TOURING MODELS

### OE REPLACEMENT AIR FILTER FOR 2008-2016 TOURING MODELS

#### DESCRIPTION

Replaces OE# 29633-08 For 2008-2013 Touring Models  
Replaces OE# 294000-45 For 2014-2016 Touring Models  
Replaces OE and 2010-2016 CVO™ # 29670-09

PART NUMBER  
HD-1508

#### PART#

HD-1508  
HD-1614  
HD-0910



### REPLACEMENT AIR FILTER FOR 2008-16 TOURING MODELS SCREAMIN' EAGLE®

#### DESCRIPTION

Replaces Screamin' Eagle® # 29244-08  
Replaces Screamin' Eagle® Ventilator # 29670-09

#### PART#

HD-0818  
HD-0910

#### DRYCHARGER®

HD-0800DK

- 5 1/2" diameter metal top plate with centered 5/16" NC weld nut to attach cover
- Three-hole drilled to fit standard mounting pattern for Screamin' Eagle® backplate
- 6" diameter molded rubber base

## AIR FILTERS FOR EVO MODELS

### OE REPLACEMENT AIR FILTER FOR 1990-99 EVO MODELS

#### DESCRIPTION

Replaces OE# 2925991A & 2933096

PART NUMBER  
HD-1390

#### PART#

HD-1390

- Fits models with and with out vent lines

### REPLACEMENT AIR FILTER (STRAIGHT ELEMENT) FOR EVO SCREAMIN' EAGLE®

#### DESCRIPTION

2" height (Replaces Screamin' Eagle® # 29055-89)

PART NUMBER  
HD-0600

#### PART#

HD-0600

- 7" diameter metal top has centered 5/16" NC weld nut to attach cover
- Top plate is three-hole drilled to fit standard mounting pattern for EVO air cleaners
- 7" diameter molded rubber base
- Requires stock mounting spacers

## AIR FILTERS FOR OTHER HARLEY-DAVIDSON® MODELS

### OE REPLACEMENT AIR FILTER FOR 2002-16 V-ROD®

#### DESCRIPTION

Replaces OE# 29437-01

PART NUMBER  
HD-1102

#### PART#

HD-1102

### OE REPLACEMENT AIR FILTER FOR 2008-12 HARLEY-DAVIDSON® XR1200™

#### DESCRIPTION

Replaces OE# 29377-08

#### PART#

HD-1208

- 7 3/8"L X 3 3/4"W X 7/8"D panel style air filter
- High-flow cotton media fits directly into the OE air cleaner assembly
- One-piece injection molded urethane sealing bead

PART NUMBER  
HD-1208

### OE REPLACEMENT AIR FILTER FOR 2015 HARLEY-DAVIDSON® XG500/750 STREET

#### DESCRIPTION

Replaces OE# 29400078

#### PART#

HD-4915

- Fits neatly behind the stock air filter cover
- Replaces air filter element and backing plate

PART NUMBER  
HD-4915



CVO™, Screamin' Eagle®, V-ROD®, and XR1200™ are trademarks of Harley-Davidson®. Harley-Davidson® is a registered trademark of H-D Michigan, Inc.

Parts Updated Daily at [KNFILTERS.COM](http://KNFILTERS.COM) or Call 800-858-3333



# **STREET PERFORMANCE**

## HIGH-FLOW AIR FILTERS™

- The original High-Flow Air Filter™ invented by K&N®
- Designed to provide low restriction, resulting in increased airflow and high performance
- Pleated media provides a large filtration area, delivering high capacity and long service intervals
- Specifically designed to fit into your OE air filter assembly for simple installation
- Pre-oiled and ready to ride



**WASHABLE  
REUSABLE  
PERFORMANCE®**

## WRENCH-OFF® OIL FILTERS

- Specially designed to be compatible with premium synthetic, blended and traditional motor oils
- Premium synthetic media provides outstanding filtration while allowing for high-flow rates
- Sturdy 17mm hex nut eases removal in hard to reach areas
- Heavy-duty canister and construction provides a high burst strength and extra protection
- Most available in black or chrome finish
- One-Year Limited Warranty



## OTHER PRODUCTS FOR STREET BIKES

### RK SERIES INTAKE SYSTEMS

– FOR METRIC CRUISERS –



SOME INTAKE SYSTEMS ARE NOT LEGAL FOR SALE OR USE ON ANY POLLUTION CONTROLLED MOTOR VEHICLE IN CALIFORNIA OR STATES ADOPTING CALIFORNIA EMISSION PROCEDURES.

See [knfilters.com](http://knfilters.com) for CARB status on each part for a specific vehicle

### PURPOSE-BUILT RACE-SPEC AIR FILTERS

– FOR PERFORMANCE TRACK BIKES –



LEGAL IN CALIFORNIA ONLY FOR RACING VEHICLES WHICH MAY NEVER BE USED, REGISTERED OR LICENSED FOR USE UPON A HIGHWAY.

See [knfilters.com](http://knfilters.com) for CARB status on each part for a specific vehicle

# RK INTAKE SYSTEMS<sup>†</sup>

## FOR METRIC CRUISERS

Developed to provide increased horsepower while delivering custom good looks and long service intervals to your metric cruiser.

- Oversized K&N<sup>®</sup> original High-Flow Air Filter™
- Pleated design provides high airflow
- High-quality custom aluminum air cleaner cover
- Powder-coated billet aluminum backing plate\*
- Dyno-tuned velocity stacks\*
- Spacers and mounting hardware included
- 10-year/million mile limited warranty

\*where applicable



RK-3940 installed on a 2014 Yamaha XVS950 Bolt

SOME INTAKE SYSTEMS ARE NOT LEGAL FOR SALE OR USE ON ANY POLLUTION CONTROLLED MOTOR VEHICLE IN CALIFORNIA OR STATES ADOPTING CALIFORNIA EMISSION PROCEDURES.

See [knfilters.com](http://knfilters.com) for CARB status on each part for a specific vehicle

See page 175 for specifications regarding emissions standards and CARB regulations.



**RK-3940**  
**CONTRAST CUT**

### 2014<sup>1</sup> / 2015-16<sup>2</sup>

## YAMAHA XVS950

## BOLT / VBOLT R-SPEC

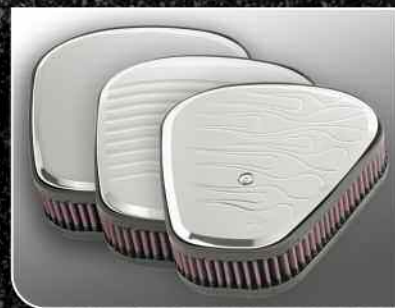

**RK-3906 - SMOOTH**  
**RK-3916 - GROOVED**  
**RK-3926 - FLAMED**

### RK SERIES COMPLETE INTAKE SYSTEMS FOR METRIC CRUISERS

HONDA	YEAR	MIRRORED DESIGN	GROOVED DESIGN	FLAMED DESIGN	CONTRAST CUT	EST. HP GAIN <sup>†</sup>
VTX1800	02-08	RK-3906 <sup>1</sup>	RK-3916 <sup>1</sup>	RK-3926 <sup>1</sup>	•	TBA
<b>KAWASAKI</b>						
VN2000 Vulcan	04-07	RK-3908 <sup>1</sup>	RK-3918 <sup>1</sup>	RK-3928 <sup>1</sup>	•	TBA
<b>YAMAHA</b>						
XVS950 Bolt / Bolt R-Spec	2014	•	•	•	RK-3940 <sup>1</sup>	+ 7 hp <sup>†</sup>
XVS950 Bolt / Bolt R-Spec	15-16	•	•	•	RK-3940 <sup>2</sup>	+ 7 hp <sup>†</sup>
XV1600 RoadStar	99-03	RK-3905-1 <sup>1</sup>	RK-3915-1 <sup>1</sup>	RK-3925-1 <sup>1</sup>	•	TBA
XV1700 RoadStar	04-12	RK-3905-1 <sup>1</sup>	RK-3915-1 <sup>1</sup>	RK-3925-1 <sup>1</sup>	•	TBA

1) 50 state street legal 2) Not legal for sale or use on any pollution controlled motor vehicle in California or states adopting California emission procedures.  
<sup>†</sup>Estimated horsepower and torque gains based on specific or similar vehicle dynamometer tests. Results will vary. See page 175 for specifications regarding emissions standards and CARB regulations.

# HIGH-FLOW AIR FILTERS™ FOR METRIC CRUISERS

Honda GL1800 Goldwing F6B



Perfect for 2-up rides on your cruiser with filled saddle bags, a long life High-Flow Air Filter™ delivers improved performance for the life of your motorcycle.

- Pleated media provides a large filtration area offering long service intervals
- Designed to provide increased horsepower and torque
- Fits into your OE Air Filter assembly



## METRIC CRUISER OE REPLACEMENT FILTERS - See page 85 for additional product listings

HONDA	YEAR	AIR FILTER	OIL FILTER	SUZUKI CONTINUED	YEAR	AIR FILTER	OIL FILTER
CMX250 Rebel	96-15	HA-2596	•	Boulevard C50	05-08	SU-8001	KN-138*
CTX700	14-15	HA-7012	KN-204*	Boulevard C50	09-15	SU-8009	KN-138*
VT600C/CD Shadow	99-07	HA-6199	KN-303*	Boulevard C90	05-09	SU-1598	KN-138*
VT750 Shadow	98-07	HA-7500	KN-303*	Boulevard M50	05-08	SU-8005	KN-138*
VT750 Shadow Aero/Spirit	04-09	HA-7504	KN-204*	Boulevard M50	09-13	SU-8009	KN-138*
VT750 Shadow	10-15	HA-7504	KN-204*	Boulevard M109R	06-14	SU-1806	KN-138*
VT1100C Shadow	89-07	HA-1187	KN-303*	VZR1800 Intruder	06-12	SU-1806	KN-138*
VTX1300C, R, S, T	03-09	HA-1330	KN-204*	<b>YAMAHA</b>			
VTX1300CR, S, T, X Fury	10-16	HA-1310	KN-204*	VMX1200 V-Max	96-07	YA-1285	KN-303*
VTX1800C, F, N, R, S, T	02-08	HA-1802	KN-204*	VMX1700 V-Max	09-16	YA-1709	KN-303*
GL1800 Gold Wing/F6B	13-16	HA-1801	KN-204*	XV250 Rte 66/Virago/V-Star	88-16	YA-2588	KN-145
GL1800 Valkyrie/ABS	14-15	HA-1801	KN-204*	XVS650 Drag Star/V-Star	96-16	YA-6598	KN-145
NC700J NM4	2016	HA-7012	•	XVS950 Bolt	14-16	YA-9514	KN-204*
<b>KAWASAKI</b>				XVS950/1300 V-Star	09-16	YA-1307	KN-204*
VN900 Vulcan Models	06-16	KA-9006	KN-303*	XVS1100 V-Star	99-09	YA-1199	KN-145
VN1500/1600 Vulcan	99-06	KA-1596	KN-204*	XVS13CA Stryker	11-16	YA-1307	KN-204*
VN1500 Vulcan Classic	07-08	KA-1596	KN-303*	XVZ1300 Royal Star Venture	02-13	YA-1399	KN-303*
VN1600 Vulcan Classic/Nomad	04-08	KA-1603	KN-204*	XV1600 Roadstar	99-03	YA-1699	KN-303*
VN1600 Vulcan Meanstreak	07-08	KA-1596	KN-303*	XV1700 RoadStar	04-14	YA-1704	KN-303*
VN1600 Vulcan Models	07-08	KA-1603	KN-303*	XV1700 RoadStar Warrior	02-09	YA-1602	KN-303*
VN1700 Vulcan Models	09-15	KA-1709	KN-303*	XV1900 Roadliner/Stratoliner	06-14	YA-1906	KN-303*
VN2000 Vulcan Models	04-06	KA-2008	KN-204*	XV1900 Raider	08-16	YA-1906	KN-303*
VN2000 Vulcan Models	07-10	KA-2008	KN-303*	<b>TRIUMPH</b>			
<b>SUZUKI</b>				America	04-14	TB-8002	KN-204*
LS650 Savage	86-04	SU-6595	KN-137	Speedmaster	04-14	TB-8002	KN-204*
Boulevard S40	05-15	SU-6595	•	Thunderbird	10-15	TB-1610	KN-204*
Boulevard S50	05-09	SU-7086	KN-138*	Rocket III	04-14	TB-2204	KN-204*
VL800 Intruder	09-13	SU-8009	KN-138*				

\* Add C for Chrome

AMERICAN V-TWIN

STREET

OFF-ROAD

WATERCRAFT/SNOW

SPECIALTY/ACCESSORIES

HAULER HORSEPOWER

APPAREL/SIGNAGE

K&N® PRODUCT LISTINGS

# HIGH-FLOW AIR FILTERS™ FOR TOURING

Ideal for long distance touring or commuting, installing a long-life High-Flow Air Filter™ delivers improved performance and extended service intervals for your motorcycle.

- Pleated media provides a large filtration area offering long service intervals
- Designed to provide increased horsepower and torque
- Fits into your OE air filter assembly



## TOURING OE REPLACEMENT FILTERS - See page 85 for additional product listings

APRILIA	YEAR	AIR FILTER	OIL FILTER
Tuono R/Tuono R Factory	06-13	AL-1004	KN-152
<b>BMW</b>			
F650GS Dakar	01-07	BM-6501	KN-151
F700GS/F800GS/Adventure	06-15	BM-8006	KN-164
R1100/R1150	93-06	BM-0400	KN-163
R1200GS/R/RT	04-15	BM-1204	KN-164
R1200GS(Water Cooled)/RS/RT	13-15	BM-1113	KN-160
K1200R	05-07	BM-1205	KN-160
K1200S	05-08	BM-1205 <sup>1</sup>	KN-160
K1200LT	98-08	BM-1299	KN-163
K1300GT/R/S	09-15	BM-1205	KN-160
K1600GT/GTL	11-15	BM-1611	KN-164
<b>BUELL</b>			
Ulysses XB12X/T	06-10	BU-9003	KN-177
<b>CAN-AM</b>			
Spyder/RS 990	08-12	CM-9908	KN-564/559
Spyder RS/ST	10-16	CM-9910	•
Spyder RT	14-15	CM-1314	•
Spyder RT	10-12	CM-9910	KN-564/559
Spyder RT	10-13	CM-9910	KN-564
<b>DUCATI</b>			
Diavel	11-15	DU-1007	KN-153
Sport/GT1000/Hypermotard	08-15	DU-1006	KN-153
Multistrada 620/1000/1100	03-09	DU-1004	KN-153
Multistrada 1200/S/Touring	10-14	DU-1210	KN-153
GT1000/Sport 1000	08-10	DU-1006	KN-153
ST2/ST3/ST4/800SS/1000SS	97-07	DU-9098	KN-153
<b>HONDA</b>			
CTX700/NC700	12-16	HA-7012	KN-204*
CTX1300/ST1300	02-15	HA-1302	KN-204*
Deauville NT 700V	06-11	HA-7010	KN-204*
GL1800 Gold Wing	01-16	HA-1801	KN-204*
NSA 700 DN-01	08-10	HA-6708	KN-204*
XL1000 Varadero	03-10	HA-1003	KN-204*
VFR1200F / Crosstourer	10-15	HA-1110	KN-204*

KAWASAKI	YEAR	AIR FILTER	OIL FILTER
KLR650	87-15	KA-6589	KN-123
Versys/Z1000	11-16	KA-1111	KN-303*
ZG1400 Concours	08-14	KA-1406	KN-303*
<b>KTM</b>			
690 Duke	07-14	KT-6907	KN-155/157
950 Adventure/SMR	03-09	KT-9504	KN-158
990 Adventure/SMT/Supermoto	07-13	KT-9907	KN-158
1190 Adventure/1290 Super Duke	13-14	KT-1113	KN-158
<b>POLARIS</b>			
Slingshot 2.4L	2015-16	PL-2415	PS-7000
<b>SUZUKI</b>			
DL650 V-Strom	02-16	SU-1002	KN-138*
DL1000 V-Strom	14-15	SU-1014	KN-138*
GSX650F Bandit/S	05-13	SU-6505	KN-138*
GSF1200/1250/Bandit	06-13	SU-6505	KN-138*
GSX1300BK B-KING	07-12	SU-1348	KN-138*
<b>TRIUMPH</b>			
America/Spdmster 800/900	04-14	TB-8002	KN-204*
Bonneville/Scrambler/Thruxton	04-15	TB-9004	KN-204*
Rocket III	04-15	TB-2204	KN-204*
Sprint/Sprint GT	05-12	TB-1005	KN-204*
Thunderbird	10-15	TB-1610	KN-204*
Tiger	07-13	TB-1005	KN-204*
Tiger 800	11-16	TB-8011	KN-204*
Tiger Explorer 1200	12-14	TB-1212	KN-204*
Trophy SE	13-14	TB-1213	KN-204*
<b>YAMAHA</b>			
FZ6	07-09	YA-6004	KN-204*
FJ-09/MT09	14-16	YA-8514	KN-204*
FZ1/FZS1000 Fazer	01-05	YA-1001	KN-303*
FZ1/Fazer	06-15	YA-1006	KN-204*
FJR1300	01-16	YA-1301	KN-148
VMX1700 V-Max	09-12	YA-1709	KN-303*
XT1200Z Super Tenere	10-16	YA-1210	KN-204*
MT07	14-15	YA-6814	KN-204*

\* Add C for Chrome 1) Requires two filters



# HIGH-FLOW AIR FILTERS™ FOR SCOOTERS

Yoshimura R&D Honda MSX125 Grom



Whether commuting or cutting through traffic, a High-Flow Air Filter™ will give your scooter an easy to install increase in performance.

- Pleated media provides a large filtration area offering long service intervals
- Designed to provide low restriction and increased performance
- Washable & reusable, easy to maintain



## SCOOTER AIR AND OIL FILTERS - Visit [knfilters.com](http://knfilters.com) for additional product listings

APRILIA	CC	YEAR	AIR FILTER	OIL FILTER
Leonardo 125/150	125/150	96-05	•	<b>KN-185</b>
Scarabeo 150/200 Rotax	200	99-03	•	<b>KN-185</b>
<b>BMW</b>				
C600 Sport	647	12-15	<b>BM-6012</b>	•
C650GT	647	12-15	<b>BM-6012</b>	•
<b>HONDA</b>				
CHF60 Metropolitan	50	02-09	<b>HA-0502</b>	•
CN250 Helix	250	86-07	<b>HA-2586</b>	•
FJS/FSC600 Silver Wing	600	01-13	<b>HA-6002</b>	<b>KN-204*</b>
MSX125 Grom	125	13-15	<b>HA-1313</b>	•
NCH50 Metropolitan	50	13-15	<b>HA-0513</b>	•
NPS50 Ruckus	50	03-15	<b>HA-0502</b>	•
NSS300 Forza	300	2014	<b>HA-2714</b>	<b>KN-204*</b>
PCX125/250	125	13-14	<b>HA-1213</b>	•
PS250 Big Ruckus	250	05-06	<b>HA-2500-1</b>	•
SH150i	150	01-12	<b>HA-1510</b>	•
SH125i/SH150i	150	13-14	<b>HA-1513</b>	•
SH300i	300	07-12	<b>HA-3011</b>	<b>KN-204*</b>
<b>KYMCO</b>				
MyRoad	700	11-12	•	<b>KN-147</b>
Xciting 500	500	05-09	•	<b>KN-147</b>
Xciting 500 Ri	500	08-12	•	<b>KN-147</b>
<b>MBK</b>				
125 Cityliner	125	07-11	•	<b>KN-141</b>
<b>PEUGEOT</b>				
Citystar	125	11-12	•	<b>KN-185</b>
Geo RS	125	07-09	•	<b>KN-185</b>
Sat RS	125	06-12	•	<b>KN-185</b>

SUZUKI	CC	YEAR	AIR FILTER	OIL FILTER
AN150 Burgman	150	95-00	•	<b>KN-131</b>
AN250 Burgman	250	99-04	<b>SU-2599</b>	<b>KN-132</b>
AN250 Burgman	250	05-07	•	<b>KN-132</b>
AN400 Burgman	400	99-06	<b>SU-2599</b>	<b>KN-132</b>
AN400 Burgman	400	07-16	<b>SU-4007</b>	<b>KN-131</b>
AN650 Burgman	650	03-15	<b>SU-6303</b>	<b>KN-138</b>
AN650 Burgman Executive	650	04-09	•	<b>KN-138</b>
FU150 Raider	150	04-10	<b>SU-1506</b>	•
UH200 Burgman	200	07-10	•	<b>KN-131</b>
<b>YAMAHA</b>				
CP250 Morphous	250	06-08	•	<b>KN-132</b>
Cygnus 125	125	02-04	<b>YA-1202</b>	•
T135	135	06-10	<b>YA-1306</b>	•
XC125SR Cygnus X SR	125	04-07	<b>YA-1202</b>	•
XC200Z Riva	200	87-90	•	<b>KN-145</b>
XP500 T-Max	500	01-07	<b>YA-5001</b>	<b>KN-147</b>
XP500 T-Max	500	08-13	<b>YA-5008</b>	<b>KN-147</b>
XP500 T-Max Special	500	06-07	<b>YA-5001</b>	<b>KN-147</b>
XQ125 Maxster/Thunder	125	01-02	<b>YA-2598</b>	•
XQ150 Maxster/Thunder	150	01-02	<b>YA-2598</b>	•
YJ125 Vino	125	04-09	•	<b>KN-143</b>
YM150	150	1999	<b>YA-2598</b>	•
YP125 Majesty	125	98-05	<b>YA-2598</b>	•
YP125R X-Max	125	06-12	<b>YA-2406</b>	<b>KN-141</b>
YP180 Majesty	180	2006	<b>YA-2598</b>	•
YP250G Grand Majesty	250	04-07	•	<b>KN-132</b>
YP250 X-MAX	250	06-15	<b>YA-2406</b>	•
YP400 Majesty	400	04-13	•	<b>KN-132</b>
YW125 Zuma	125	09-15	<b>YA-1209</b>	•

AMERICAN V-TWIN

STREET

OFF-ROAD

WATERCRAFT/SNOW

SPECIALTY/ACCESSORIES

HAULER HORSEPOWER

APPAREL/SIGNAGE

K&N® PRODUCT LISTINGS

# HIGH-FLOW AIR FILTERS™ FOR SPORTBIKES

Designed to provide low restriction for improved throttle response, horsepower, and torque.

- Washable pleated media provides a large filtration area offering long service intervals
- A great first step in your performance package
- Fits into your OE air filter assembly



Team Empire Stunts - Triumph Daytona 675



## SPORTBIKE OE REPLACEMENT FILTERS - See page 85 for additional product listings

APRILIA	YEAR	AIR FILTER	OIL FILTER
RSV Mille/1000R/Factory	05-13	AL-1004	KN-152
RSV4 R	09-13	AL-1010	KN-138*
BMW			
S1000R/S1000RR	10-15	BM-1010	KN-160
HP4	12-14	BM-1010	•
R nineT	14-15	BM-1204	KN-164
DUCATI			
Monster 696/796	10-14	DU-6908	KN-153
1198/R/S/Corse	10-11	DU-1007	KN-153
Street Fighter/848	08-15	DU-1007	KN-153
899 Panigale	13-15	DU-1112	•
1199 Panigale	12-15	DU-1112	KN-159
Monster 1100	09-13	DU-6908	KN-153
HARLEY-DAVIDSON®			
XR1200™ X/Sportster®	08-12	HD-1208	KN-170*
HONDA			
CBR250R	11-13	HA-2511	KN-112
CBR500R	13-15	HA-5013	KN-204*
CBR600RR	07-15	HA-6007	KN-204*
CBR650F/ABS	14-15	HA-6414	KN-204*
CB1000R	08-15	HA-1009	KN-204*
CBF1000	12-13	HA-1009	KN-204*
CBR1000RR	04-07	HA-1004	KN-204*
CBR1000RR	08-15	HA-1008	KN-204*
KAWASAKI			
EX250R Ninja	08-12	KA-2508	KN-401
EX300R Ninja	13-15	KA-2508	KN-303*
EX650R Ninja/ERGN	12-15	KA-6512	KN-303*
ZX6R Ninja	07-08	KA-6007	KN-303*
ZX6R Ninja	09-15	KA-6009	KN-303*
ZX10R Ninja	08-10	KA-1008	KN-303*
ZX10R Ninja	11-15	KA-1011	KN-303*

KAWASAKI CONTINUED	YEAR	AIR FILTER	OIL FILTER
Z1000/ZX1000 Ninja	11-15	KA-1111 <sup>2</sup>	KN-303*
Z1000	10-11	KA-1010 <sup>1</sup>	KN-303*
ZX14R Ninja/ZZR1400	06-11	KA-1406	KN-303*
KTM			
690 Duke/Duke R	14-15	KT-6912	KN-155
1190 RC8	08-14	KT-1108	KN-158
SUZUKI			
GSXR600/750	06-10	SU-7506	KN-138*
GSXR600/750	11-15	SU-7511	KN-138*
GSXR1000	05-08	SU-1005	KN-138*
GSXR1000	09-15	SU-1009	KN-138*
GSX1300R Hayabusa	99-07	SU-1399	KN-138*
GSX1300R Hayabusa	08-15	SU-1308	KN-138*
GSX1300BK B-King	07-12	SU-1348	KN-138*
TRIUMPH			
Daytona 675/Street Triple	06-12	TB-6706	KN-204*
Daytona 675/Street Triple	13-14	TB-6713	KN-204*
Speed Triple	05-10	TB-1005	KN-204*
Speed Triple	11-14	TB-1011	KN-204*
YAMAHA			
FZ6	07-09	YA-6004	KN-204*
FZ6R/XJ6	09-15	YA-6009	KN-204*
FZ8	10-15	YA-1006	KN-204*
FZ-09	14-15	YA-8514	KN-204*
FZ1	06-15	YA-1006	KN-204*
SR400	14-15	YA-5008	•
YZF600R	97-07	YA-6096	KN-303*
YZF R6	06-07	YA-6006	KN-204*
YZF R6	08-15	YA-6008	KN-204*
YZF R3	2015	YA-3215	KN-204*
YZF R1	07-08	YA-1007	KN-204*
YZF R1	09-14	YA-1009	KN-204*

\* Add C for Chrome 1) Before VIN# ZRT00DE10765 2) After VIN# ZRT00DE010766

XR1200™ and Sportster® are trademarks of Harley-Davidson®. Harley-Davidson® is a registered trademark of H-D Michigan, Inc.

# HIGH-FLOW AIR FILTERS™ FOR PERFORMANCE TRACK BIKES

Red Bull/Road Race Factory Yamaha - Jake Gagne



Purpose-built for racing and closed-course track bikes, RACE-SPEC air filters are designed to increase horsepower by delivering extremely low restriction.

- Developed to increase horsepower and acceleration for the race track
- Specially pleated two-ply cotton race filter media
- Fewer pleats than standard K&N® replacement air filters
- Fits directly in OE air box
- Washable and reusable
- K&N® One Year Limited Warranty

**PURPOSE BUILT  
RACE-SPEC  
HIGH-FLOW  
AIR FILTERS™**

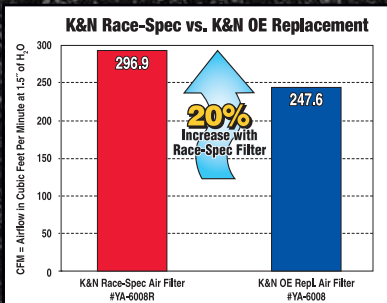

Airflow rates shown are estimates based on individual tests of specific air filters. Results will vary.

**Fuel management modifications  
WILL be necessary.**

**These filters are designed for  
closed-course competition use only.**

**\* LEGAL IN CALIFORNIA ONLY FOR RACING VEHICLES WHICH MAY NEVER BE USED, REGISTERED OR LICENSED FOR USE UPON A HIGHWAY.**

See [knfilters.com](http://knfilters.com) for CARB status on each part for a specific vehicle

See page 175 for specifications regarding emissions standards and CARB regulations.



**TWO-LAYER COTTON MEDIA  
WITH FEWER PLEATS**



**SPECIFIC SEALING  
BEAD**

## RACE-SPEC HIGH-FLOW AIR FILTERS™

APRILIA	YEAR	PART#	KAWASAKI	YEAR	PART#
RSV4 R/Tuono V4	09-15	AL-1010R	ZX6R Ninja	07-08	KA-6007R
<b>BMW</b>			ZX6R Ninja	09-16	KA-6009R
S1000RR	10-15	BM-1010R	ZX10R Ninja	08-10	KA-1008R
HP4	12-15	BM-1010R	ZX10R Ninja	11-15	KA-1011R
<b>DUCATI</b>			<b>SUZUKI</b>		
848	08-14	DU-1007R	GSXR600/750	06-10	SU-7506R
899/1199 Panigale	12-15	DU-1112R	GSXR600/750	11-15	SU-7511R
1098/1198R/S/SP	07-11	DU-1007R	GSXR1000	05-08	SU-1005R
<b>HONDA</b>			GSXR1000	09-16	SU-1009R
CBR600RR	07-15	HA-6007R	GSX1300R	08-16	SU-1308R
CBR1000RR	04-07	HA-1004R	<b>YAMAHA</b>		
CBR1000RR	08-15	HA-1008R	YZF R6	08-16	YA-6008R
			YZF R1	09-14	YA-1009R

Parts Updated Daily at [KNFILTERS.COM](http://KNFILTERS.COM) or Call 800-858-3333

AMERICAN V-TWIN

STREET

OFF-ROAD

WATERCRAFT/SNOW

SPECIALTY/ACCESSORIES

HAULER HORSEPOWER

APPAREL/SIGNAGE

K&N® PRODUCT LISTINGS



# **OFF-ROAD PERFORMANCE**

## HIGH-FLOW AIR FILTERS™

- Designed to provide increased airflow
- Pleated media increases surface area and capacity for extreme conditions
- Custom base seal specific to each application
- Washable & reusable
- K&N® One Year Limited Warranty
- K&N® Drycharger® available for extended service intervals



## PERFORMANCE OIL FILTERS™

- 17mm hex nut for easy wrench-off\*
- Pre-drilled for safety wire attachment\*
- Premium synthetic blend media provides outstanding filtration at high flow rates
- High-performance anti-drainback valve\*
- Heavy duty canister construction

\*where applicable



## OTHER PRODUCTS FOR OFF-ROAD VEHICLES

### AIRCHARGER® INTAKE SYSTEMS†

– FOR ATVs / UTVs / SIDE BY SIDES –



### XSTREAM® POWERLID®

– FOR SPORT ATVs –



### XSTREAM® SERIES AIR FILTERS

– FOR MOTOCROSS BIKES –



†

SOME INTAKE SYSTEMS ARE NOT LEGAL FOR SALE OR USE ON ANY POLLUTION CONTROLLED MOTOR VEHICLE IN CALIFORNIA OR STATES ADOPTING CALIFORNIA EMISSION PROCEDURES.

See [knfilters.com](http://knfilters.com) for CARB status on each part for a specific vehicle

See page 175 for specifications regarding emissions standards and CARB regulations.

# HIGH-FLOW AIR FILTERS™

## FOR OFF-ROAD AND MOTOCROSS BIKES

K&N® air filters were originally designed for the extreme demands of off road racing to provide long service intervals and increased performance.

- Pleated media allows low restriction, resulting in improved throttle response, horsepower, and torque
- Deep pleats provides a large surface area, resulting in high capacity
- Fits directly into your stock air box



Icon Moto - Portland to Dakar

Photo: hameisterphoto.com



### OFF-ROAD MOTORCYCLE REPLACEMENT FILTERS - See page 85 for additional product listings

APRILIA	YEAR	AIR FILTER	OIL FILTER
RXV/SXV 450/550 Enduro	06-11	AL-4506	KN-563
<b>HONDA</b>			
XR80/XR100R	85-03	HA-1088	•
CRF80/100F	04-13	HA-1088	•
CRF150/230F	03-15	HA-1503	•
CR80/85R	86-07	HA-8086	•
CR125/250/500R	91-01	HA-2591	•
CRF250L	13-15	HA-2513	KN-112
XR250R	86-04	HA-1312	KN-112
XR400R	96-04	HA-1314	KN-112
XR650L	93-16	HA-6592	KN-112
XR650R	00-07	HA-6500	KN-112
<b>HUSQVARNA</b>			
FE 250/350	14-15	KT-4511XD	KN-652
FE 450	14-15	•	KN-655
FE 501	14-15	KT-4511XD	KN-655
TC/TE 125/250/300	14-15	KT-4511XD	•
<b>KAWASAKI</b>			
KLX110	02-16	KA-1102	KN-112
KLX125/L	03-06	KA-1203	KN-132
KLX140/L	08-15	KA-1408	KN-112
KX65/80/85/100	91-16	KA-8088	•
KDX200/KDX220R	89-06	KA-1287	•
KLX250S/SF	09-10	•	KN-112
KLX250/300R	96-07	KA-1287	KN-112
KLX450R	08-11	KA-4408	KN-112
KLR650	87-15	KA-6589	KN-123
<b>KTM</b>			
250 SX-F	07-13	KT-4511XD	KN-655
250 XC-F/XCF-W	08-12	KT-4511XD	KN-655
400EXC/XC-W	08-11	KT-4511XD	KN-652

KTM CONTINUED	YEAR	AIR FILTER	OIL FILTER
450EXC/XC-F/XC-W	08-11	KT-4511XD	KN-652
450XC-W	12-15	KT-4511XD	KN-655
450SX-F	07-12	KT-4511XD	KN-652
450SX-F	13-15	•	KN-655
500SXF/EXC-R	13-15	KT-4511XD	KN-652
505SXF/EXC-R	08-12	KT-4511XD	KN-652
530EXC/EXC-R/XC-WR	08-12	KT-4511XD	KN-652
690 SMC	08-12	KT-6907	KN-155/157
690 Supermoto	07-08	KT-6907	KN-155/157
690 Enduro	08-14	KT-6908	KN-155/157
950 Super Enduro	06-09	KT-9504	KN-158
990 SM R/SM T	10-13	KT-9907	KN-158
<b>SUZUKI</b>			
RM85/L	86-12	SU-8086	•
DRZ125/L	03-14	KA-1203	KN-132
DRZ250	01-07	SU-2501	KN-136
DRZ400/E/S/SM	00-15	SU-4000	KN-139
DR650SE	96-14	SU-6596	KN-137
<b>YAMAHA</b>			
TTR90/E	00-07	YA-9001	•
TTR125/E/L/LE/LW	00-15	YA-1201	•
TTR225	00-04	YA-2292	KN-143
TTR230	05-15	YA-2305	KN-143
TTR250	00-06	YA-3586	KN-142
YZ85	03-15	YA-8502	•
WR250R/WR250X	07-15	YA-3586	KN-140
XT225	01-07	YA-2292	KN-143
XT250	09-15	YA-2509	KN-140
XT660R/X/Supermotard	04-15	YA-6604	KN-145
YZ450F	10-13	YA-4510	KN-140
YZ450F	14-15	YA-4514XD	KN-140

# HIGH-FLOW AIR FILTERS™ FOR OFF-ROAD AND MOTOCROSS BIKES

Monster Energy / Babbitt's Kawasaki - Jacob Hayes



Designed to provide increased horsepower & crisp throttle response, these air filters inspire longer motos!

- Designed to provide low restriction, resulting in increased throttle response and horsepower
- Pleated media provides a large filtration area and high capacity for extended service intervals
- Multiple layers of tightly woven "XD" cotton gauze media offers excellent filtration in dusty conditions\*
- Two-piece design eases installation and removal\*
- Custom base seal specific to each application
- K&N® One Year Limited Warranty

K&N® XStream® Series Motocross Air Filter.  
U.S. Patented Design

\*Where applicable



**2-PIECE CONSTRUCTION  
EASES INSTALLATION**

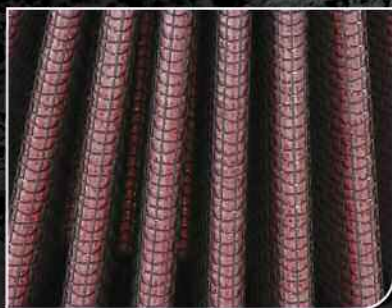

**DEEP PLEATS PROVIDE  
HIGH CAPACITY**



**INTEGRATED TONGUE-AND-  
GROOVE TOP SEAL**

## XSTREAM® SERIES MOTOCROSS AIR FILTERS - See page 85 for additional product listings

HONDA	YEAR	AIR FILTER	OIL FILTER	125/200/250/300 EXC/MXC/SX	98-07	KT-5201	•
CRF150R/Expert	07-16	HA-1507	KN-116	250 SX-F	05-06	KT-5201	KN-655
CRF250R	04-09	HA-4503XD	KN-116	250 SXS/XC/XCF-W	06-07	KT-5201	KN-655
CRF250R	10-13	HA-4509XD	KN-116	400EXC/MXC/XC-W/SX	00-07	KT-5201	KN-155/157
CRF250R	14-16	HA-4513XD	KN-116	450EXC/MXC/XC-W/SMR	03-07	KT-5201	KN-155/157
CRF250X/450X	04-16	HA-2505XD	KN-116	450SX	03-06	KT-5201	KN-155/157
CRF450R	2002	HA-4502	KN-116	525EXC/MXC/SX/XC-W	03-06	KT-5201	KN-155/157
CRF450R	03-08	HA-4503XD	KN-116	<b>SUZUKI</b>			
CRF450R	09-12	HA-4509XD	KN-116	RM125/250	06-08	YA-2506XD	•
CRF450R	13-16	HA-4513XD	KN-116	RM250	99-04	SU-2596	•
<b>HUSQVARNA</b>				RMZ250	04-06	KA-2504	KN-207
CR/TC/TE/WR 125/250/450/510	03-09	HU-1200	KN-154	RMZ250/450	07-16	YA-2506XD	KN-207
TC/TE/TXC 250/310	10-13	HU-1200	KN-116	<b>YAMAHA</b>			
<b>KAWASAKI</b>				YZ125/250	97-16	YA-2506XD	•
KX125/KX250	97-08	KA-1297	•	YZ250F/400F/426F	98-02	YA-2506XD	KN-142
KX250F	04-06	KA-2504	KN-207	YZ250F	09-13	YA-2506XD	KN-140
KX250F	06-16	KA-2506XD	KN-207	WR250F/WR450F	09-15	YA-4503	KN-140
KX450F	06-16	KA-2506XD	KN-112	YZ450F	03-09	YA-2506XD	KN-141
<b>KTM</b>	<b>YEAR</b>	<b>AIR FILTER</b>	<b>OIL FILTER</b>				

AMERICAN V-TWIN

STREET

OFF-ROAD

WATERCRAFT/SNOW

SPECIALTY/ACCESSORIES

HAULER HORSEPOWER

APPAREL/SIGNAGE

K&N® PRODUCT LISTINGS

# HIGH-FLOW AIR FILTERS™

## SPECIALTY CLAMP-ON AIR FILTERS FOR PIT BIKES

K&N® clamp on racing filters provide the added air flow your bike needs for even better performance.

- Pleated media offers a large surface area for low restriction, resulting in improved throttle response
- Constructed with ultra-strong molded pliable rubber flanges to absorb vibration and allow for secure attachment
- Flanges can be stretched up to 1/16" (1.5mm) to fit in between sizes
- K&N® Drycharger® filter wrap available for use in wet conditions or for extended service intervals.



Big Minis - Jack Phinn



Legal in California only for racing vehicles which may never be used, registered or licensed upon a highway.



**PLEATED MEDIA PROVIDES A LARGE SURFACE AREA**

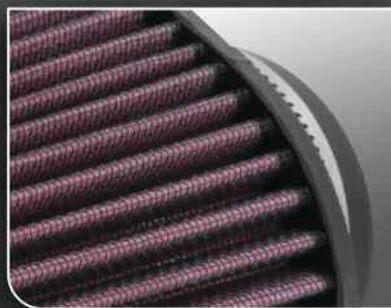

**PLIABLE MOLDED FLANGES ABSORB VIBRATION**



**K&N® DRYCHARGER® INSTALLED**

### SPECIALTY FILTERS FOR MODIFIED PIT BIKES - See page 152 for additional product listings

APPLICATION	DESCRIPTION	CARB	PART #	PRECHARGER®
CRF50	1 1/8" F, 2 1/4" B, 2" T, 2 1/2" L	16mm	RC-2540	RC-2540PK
CRF50	1 3/8" F, 2 1/2" B, 2" T, 2 1/4" L	18mm	RC-0790	RC-0790PK
CRF50	1 1/4" F, 3" OD, 3" L	18mm	RU-0060	22-8008PK
CRF50	1 9/16" F, 3" B, 2" T, 3" L	20-22mm	RC-2310	22-8028PK
CRF50	1 11/16" F, 3" B, 2" T, 2 3/4" L	24mm	RC-1070	22-8028PK
CRF50	1 11/16" F, 3 1/2" B, 2" T, 4" L	26-28mm	R-1080	22-8029PK
CRF50	1 11/16" F, 3" B, 2" T, 4" L, 40°F	26-28mm	R-1100	22-8048PK
CRF50	1 7/8" F, 3" B, 2" T, 3 11/16" L, 10°F	28mm	RC-1290	22-8048PK
KLX110/DRZ110	OE replacement filter	Stock	KA-1102	•
KLX110	1 9/16" F, 3 1/2" B, 1 1/2" L	22-26mm	RC-0170	RC-0170DK
KLX110	1 3/4" F, 3 1/2" B, 1 1/2" L	26-28mm	RC-2870	RC-0170DK
KLX110	1 3/4" offset F, 4 1/2" B, 1 1/2" L	26-28mm	RC-0330	25-0330



# HIGH-FLOW AIR FILTERS™

## SPECIALTY CLAMP-ON AIR FILTERS FOR DIRT TRACK RACING

2013 GNC Champion Brad Baker and 2014 GNC Champion Jared Mees



These dirt track air cleaners are large by design to allow extra dirt holding capacity without restricting air flow.

- Constructed with strong molded, pliable rubber flanges that absorb vibration and allow for secure attachment
- The "D" shaped oval filter with a long neck permits clamping onto the velocity stack in such a manner as not to obstruct the airflow to the velocity stack
- K&N® Drycharger® filter wrap available for extended service intervals



**PLIABLE MOLDED FLANGES ABSORB VIBRATION**



**K&N® DRYCHARGER® INSTALLED**



**XSTREAM® SERIES AIR FILTER INSTALLED**

### SPECIALTY FILTERS FOR DIRT TRACK RACING - See page 152 for additional product listings

FLANGE ID	SHAPE	DIMENSIONS	FLANGE STYLE	PART #	PRECHARGER®
2-1/4"	Round	3-1/2" outer diameter, 5" high	5/8" long	RU-0610	RU-0510PK
2-1/4"	Round	3-1/2" outer diameter, 6" high	20° angle 1" long	RU-1720	RU-0520PK
2-7/16"	Oval	4-1/2" X 3-3/4", 6" high	10° angle 1" long	RU-1230	RU-1230PK
2-7/16"	Oval	4-1/2" X 3-3/4", 7" high	10° angle 1" long	RU-1240	RU-1240PK
2-7/16"	Oval	4-1/2" X 3-3/4", 9" high	10° angle 1" long	RU-1260	RU-1260PK
2-7/16"	XStream Round	4-1/2" base, 4" top, 6-1/8" high	20° angle 2-15/16" long	RX-3800	RX-3820PK
2-1/2"	"D" Oval	4-1/2" X 3-3/4", 7" high	10° angle 2-1/8" long	RU-1830	RU-1240PK
2-1/2"	"D" Oval	4-1/2" X 3-3/4", 9" high	10° angle 2-1/8" long	RU-1840	RU-1260PK
2-1/2"	Round	3-1/2" outer diameter, 4" high	5/8" long	RD-0700	RU-0500PK
2-1/2"	Round	3-1/2" outer diameter, 6" high	5° angle 1" long	RB-0720	RU-0520PK

These products are not street legal on vehicles with regulated emission control systems unless used as a direct replacement air filter for a street legal intake system.

# HIGH-FLOW AIR FILTERS™

## FOR SPORT ATVs

Bolt-on performance that offers long life and is extremely easy to maintain in racing or extreme conditions.

- Designed to provide low restriction, resulting in increased throttle response and horsepower
- Pleated media provides a large filtration area and high capacity for extended service intervals
- K&N® Drycharger® available for wet conditions or extended service intervals



Wienen Motorsports - Chad Wienen

Photo: Harlen Foley



### SPORT ATV REPLACEMENT FILTERS - See page 139 for additional product listings

ARCTIC CAT	YEAR	AIR FILTER	FILTER WRAP	OIL FILTER
DVX400/TS	04-08	SU-4002	•	KN-139
<b>CAN-AM</b>				
DS450X/MX/XC	08-15	CM-4508	CM-4508DK	KN-560
DS650/X	00-07	BD-6500	YA-3502PK	KN-152
<b>HONDA</b>				
TRX90	94-16	HA-1088	22-8008PK	•
TRX250EX / X	01-16	HA-2501	YA-3504PK	•
TRX300EX/X	93-09	HA-3094	HA-3094PR	KN-113
TRX400EX/X	99-14	HA-4099	22-8016PK	KN-113
TRX450R	04-05	HA-4504	HA-4504PR	KN-116
TRX450R/ER	06-14	BD-6500	YA-3502PK	KN-116
TRX700XX	08-09	HA-6808	•	KN-112
<b>KAWASAKI</b>				
KFX80	03-06	SU-8087	•	•
KFX450R	08-14	KA-4508	KA-4508DK	KN-112
KFX700	04-11	KA-6503	KA-6503PK	KN-204
<b>KYMCO</b>				
KXR250	2004	KY-2504	SU-2504PK	•
Mongoose 250/300	06-10	KY-2504	SU-2504PK	•

POLARIS	YEAR	AIR FILTER	FILTER WRAP	OIL FILTER
Outlaw 450 MXR	08-09	•	•	KN-155/157
Outlaw 525	07-11	PL-5207	PL-5207DK	KN-155/157
<b>SUZUKI</b>				
LT80 QuadSport	87-06	SU-8087	•	•
LTZ250 QuadSport	04-09	SU-2504	SU-2504PK	KN-132
LTZ400 QuadSport	03-13	SU-4002	SU-4002PK	KN-139
LTR450 Quadracer	06-09	SU-4506	•	KN-139
<b>YAMAHA</b>				
YFM125/250 Raptor	09-13	YA-2088	YA-2088PK	•
YFS200 Blaster	88-06	YA-2088	YA-2088PK	•
YFM250R Raptor	08-13	YA-2088	YA-2088PK	KN-140
YFM350R Raptor	04-13	YA-6602	YA-4350PK	KN-142
YFM350X Warrior	87-04	YA-4350	YA-4350PK	KN-141
YFZ350 Banshee	87-06	YA-3502	YA-3502PK	KN-142
YFZ450	04-06	YA-4504	YA-4504PK	KN-141
YFZ450	07-15	YA-4504	YA-4504PK	KN-140
YFM660R Raptor	01-05	YA-6601	YA-6601DK	KN-145
YFM700R Raptor	06-15	YA-7006*	RU-0520PK	KN-145

\*NOTE: Includes Billet Intake Adaptor

### SPECIALTY FILTERS FOR ATV RACING - See page 152 for additional product listings

K&N® specialty filters for ATV racing are designed to be used on aftermarket oversized billet intake adaptors.

FLANGE I.D.	BASE	TOP	HEIGHT	PART#	FILTER WRAP	FLANGE I.D.	BASE	TOP	HEIGHT	PART#	FILTER WRAP
2-7/8"	4"	4"	6"	RU-1620	RU-1470PK	3 1/2"	4 5/8"	3 1/2"	7"	RU-3130	RU-3130DK
3" 5"	4 1/2"	4 1/2"	4"	RB-0900	RB-0900DK	4"	5 3/8"	4 3/8"	5"	RU-2520	•
3"	5"	5"	5"	RU-2430	RU-2430PK	4"	5 3/8"	4 3/8"	7"	RU-2590	RU-2590DK
3-1/2"	5"	5"	3"	RU-1790	22-8015PK	4 1/2"	5 7/8"	5"	3-1/4"	RU-3110	•
3-1/2"	5"	3 1/2"	4"	RU-2990	•	4 1/2"	5 7/8"	4 1/2"	6"	RU-4740	22-8033PK
3-1/2"	5"	5"	5 5/8"	RU-5114	CM-4508DK	4 1/2"	5 7/8"	5"	6"	RU-3480	RU-3480PK

\* Add C for Chrome

# HIGH-FLOW AIR FILTERS™ FOR UTILITY ATVs

Suzuki KingQuad 



Simple installation provides long life and low end power for trail riding or working the farm.

- Designed to provide low restriction, resulting in increased horsepower and torque
- Pleated media provides a large filtration area and high capacity for long service intervals
- Washable, reusable, pre-oiled, and ready to install
- K&N® Drycharger® available for wet conditions or extended service intervals



## UTILITY ATV REPLACEMENT FILTERS - See page 139 for additional product listings

ARCTIC CAT	YEAR	AIR FILTER	FILTER WRAP	OIL FILTER
250/300 2x4/4x4	98-05	AC-3098	AC-3098PK	KN-132
400 4X4	06-08	AC-4004	•	KN-138
500 4X4	05-09	AC-4004	•	KN-138
550/650/700	08-15	AC-7009	•	KN-621
1000XT/H2/Mud Pro	13-14	AC-1009	•	KN-621

### CAN-AM

Outlander/Renegade 500	07-12	BD-6506	22-8016PK	KN-152
Outlander/Renegade 500	13-15	CM-8012	•	KN-152
Outlander/Renegade 650	07-12	BD-6506	22-8016PK	KN-152
Outlander Max 650	09-12	CM-8009	•	KN-152
Outlander/Renegade 650	12-15	CM-8012	•	KN-152
Outlander 800	07-08	BD-6506	22-8016PK	KN-152
Outlander Max 800	09-12	CM-8009	•	KN-152
Outlander/Renegade 800/1000	12-15	CM-8012	•	KN-152

### HONDA

TRX250 Recon	02-14	HA-2501	HA-3504PK	•
TRX350/400 Rancher	00-06	HA-3500	HA-3500PR	KN-113
TRX420 Rancher	07-14	HA-4207	•	KN-113
TRX500 Foreman	05-14	HA-5000	HA-5000PK	KN-113
TRX500 Foreman Rubicon	01-11	HA-5000	HA-5000PK	KN-111
TRX500 Foreman Rubicon	12-16	HA-6806	HA-6806DK	KN-111
TRX680 Rincon	06-16	HA-6806	HA-6806DK	KN-111

### KAWASAKI

KLF220 Bayou	88-02	KA-2288	KA-2288PL	KN-123
KLF250 Bayou	03-11	KA-2288	KA-2288PL	KN-123
KLF300 Bayou	89-04	KA-4093	KA-4093PL	KN-123
KVF360 Prairie	03-13	KA-3603	KA-3603PK	KN-204
KVF650 Prairie	2002	KA-6502	•	KN-204
KVF650 Brute Force	03-13	KA-6503	KA-6503PK	KN-204
KVF650 Brute Force 4X4i	07-13	KA-7504	KA-7504PK	KN-204
KVF700 Prairie	04-06	KA-6503	KA-6503PK	KN-204

KAWASAKI CONTINUED	YEAR	AIR FILTER	FILTER WRAP	OIL FILTER
KVF750 Brute Force	08-15	KA-7408	KA-7408DK	KN-204
<b>KYMCO</b>				
MXU 250/300/400	05-09	KY-2504	SU-2504PK	•

### POLARIS

Phoenix 200	05-16	PL-1004	PL-1004PK	•
Hawkeye/Sportsman 300	06-10	PL-1004	PL-1004PK	KN-303
Trail Boss 325/330	02-09	PL-1005	HA-3094PR	KN-303
Trail Blazer/Trail Boss 330	10-13	PL-1003	PL-1003PK	KN-303
Sportsman 400	08-14	PL-1003	PL-1003PK	KN-303
Sportsman/Scrambler 500	97-13	PL-1003	PL-1003PK	KN-303
Sportsman 550	10-14	PL-1003	PL-1003PK	•
Sportsman 550 XP	09-12	PL-5509	PL-1003PK	•
Sportsman 800	05-14	PL-1003	PL-1003PK	KN-198
Sportsman 850	07-15	PL-1003	PL-1003PK	•
Sportsman XP 850	09-14	PL-5509	PL-1003PK	•

### SUZUKI

LTF250 Ozark	02-14	SU-2504	SU-2504PK	KN-132
LTA400A/F KingQuad	08-15	SU-5002	SU-4002PK	KN-138
LTF400 Eiger/500F Vinson	02-07	SU-5002	SU-4002PK	KN-138
LTA450X KingQuad	07-09	SU-7005	SU-7005DK	KN-138
LTA500XP KingQuad	11-14	SU-5002	SU-4002PK	KN-138
LTA700X KingQuad	05-07	SU-7005	SU-7005DK	KN-138
LTA750X KingQuad	08-14	SU-7005	SU-7005DK	KN-138

### YAMAHA

YFM125/250 Grizzly	08-13	YA-2088	YA-2088PK	•
YFM350 Grizzly	07-14	YA-3504	YA-3504PK	KN-204
YFM450 Grizzly	05-14	YA-3504	YA-3504PK	KN-204
YFM550 Grizzly	09-14	YA-7007	•	KN-204
YFM660 Grizzly	07-08	YA-6602	YA-4350PK	KN-204
YFM500/700F Grizzly	09-15	YA-7007	•	KN-204

# HIGH-FLOW AIR FILTERS™

## FOR SIDE BY SIDES

Great for sand dunes or extreme conditions, these filters provide increased performance and long service life with simple installation.

- Designed to provide low restriction, resulting in increased throttle response and horsepower
- Pleated media provides a large filtration area and high capacity for long service intervals
- K&N® Drycharger® available for wet conditions or extended service intervals



H&M Motorsports - Davi Haagsma

Photo: Harlen Foley

### SIDE BY SIDE REPLACEMENT FILTERS - See page 139 for additional product listings

ARCTIC CAT	YEAR	AIR FILTER	FILTER WRAP	OIL FILTER
Prowler 550	09-15	AC-7009	•	•
Prowler 650 H1	06-07	AC-4004	•	KN-621
Prowler 700	09-15	AC-7009	•	KN-621
Wildcat Trial/Sport 700	14-15	AC-7014	•	•
Wildcat 1000	13-16	AC-1012	AC-1012DK	KN-621
<b>CAN-AM</b>				
Commander 800/1000	11-15	CM-8011	•	KN-152
Maverick 1000 X DS	2015	CM-9715	•	KN-152
Maverick 1000	13-15	CM-8011	•	KN-152
<b>HONDA</b>				
MUV700 Big Red	09-13	HA-5000	HA-5000PK	KN-111
Pioneer 500	15-16	HA-5015	•	•
SXS700 Pioneer	14-16	HA-5000	HA-5000PK	KN-111
<b>JOHN DEERE</b>				
Gator	All	E-4552	•	•
<b>KAWASAKI</b>				
KAF400 Mule 400/600		KA-4093	KA-4093PL	KN-128
KAF620/950 Mule	01-14	KA-6201	•	KN-128
KRF750 Teryx 4X4	08-12	KA-7508	KA-7508DK	KN-204
KRT750 Teryx4	12-13	KA-7512	•	KN-204
KRF750 TERYX FI 4X4	2013	KA-7513	•	KN-204

POLARIS	YEAR	AIR FILTER	FILTER WRAP	OIL FILTER
Ranger RZR 170	10-14	PL-1710	PL-1004PK	•
Sportsman Ace 325	14-16	PL-3214	PL-3214DK	•
Ranger 400	10-14	PL-5008	•	KN-303
Ranger 500 4x4 EFI	06-13	PL-5008	•	KN-303
Ranger RZR 570	12-14	PL-5712	•	KN-198
Ranger 700	07-09	PL-5008	•	KN-198
Ranger XP 760	11-12	PL-8007	PL-8007DK	•
Ranger RZR/S 800	08-14	PL-8007	PL-8007DK	KN-198
Ranger Crew 800	11-14	PL-8007	PL-8007DK	KN-198
Ranger XP 875	13-14	PL-5712	•	KN-198
Ranger RZR XP 900	2015	PL-8715	•	•
Ranger RZR XP 900	2013	PL-9011	•	KN-198
Ranger RZR XP1000	14-16	PL-1014	PL-1014DK	KN-198
<b>YAMAHA</b>				
YXR450 Rhino	07-09	YA-6504	YA-6504PK	KN-204
YXR660 Rhino	04-06	YA-6504	YA-6504PK	KN-303
YXR660 Rhino	2007	YA-6504	YA-6504PK	KN-204
YXR700 Rhino	08-13	YA-7008	YA-7008DK	KN-204
YXM700 Viking	14-15	•	•	KN-204

# HIGH-FLOW AIR FILTERS™ FOR SPORT ATVs

Photo: Harlen Foley

CT Racing - Danny Prather



Developed to provide increased capacity for extreme conditions found in long distance desert racing.

- Replaces restrictive stock air box lid and snorkles
- Increases capacity for extreme conditions
- Mounts using OEM mounting tabs
- Use in conjunction with a K&N® High-Flow Air Filter™ for increased performance

K&N® ATV Powerlid® Air Filter. U.S. Patented Design



**INCLUDES NECESSARY  
JETS**



**DRYCHARGER® INCLUDED FOR  
EXTENDED SERVICE INTERVALS**



**INCREASES CAPACITY FOR  
EXTREME CONDITIONS**

## SPORT ATV XSTREAM® POWERLID®

ARCTIC CAT	CC	YEAR	POWERLID®	POWERLID® DRYCHARGER®
DVX400/TS	400	04-08	SU-4002-T	SU-4002-TDK
<b>HONDA</b>				
TRX400EX	400	99-09, 12-14	HA-4099-T	HA-4099-TDK
TRX450R	450	04-05	HA-4504-T	HA-4504-TDK
TRX450R/ER	450	06-09, 12-14	HA-4506-T	HA-4504-TDK
<b>KAWASAKI</b>				
KFX400	400	03-06	SU-4002-T	SU-4002-TDK
<b>SUZUKI</b>				
LTZ400 QuadSport	400	03-09, 12-13	SU-4002-T	SU-4002-TDK
<b>YAMAHA</b>				
YZF350 Banshee	350	87-06	YA-3502-T	YA-3502-TDK
YZF450/SE	450	04-13	YA-4504-T	YA-4504-TDK
YFM660R Raptor	660	01-05	YA-6601-T	YA-6601-TDK

AMERICAN V-TWIN

STREET

OFF-ROAD

WATERCRAFT/SNOW

SPECIALTY/ACCESSORIES

HAULER HORSEPOWER

APPAREL/SIGNAGE

K&N® PRODUCT LISTINGS

# AIRCHARGER® INTAKE SYSTEMS† FOR SPORT ATVs

Developed for Motocross and TT, these complete systems are designed to increase horsepower for your sport ATV.

- Guaranteed to increase horsepower
- Completely replaces the OE air box assembly
- Roto-molded polyethylene intake tube offers low restriction
- Oversized powder-coated airbox / heat shield
- Oversized K&N® "XD" High-Flow Air Filter™ for high capacity and efficiency
- Includes K&N® Drycharger® and separate crankcase breather\*
- K&N® One Year Limited Warranty

\*Where applicable



DASA Racing - Jared Hulliung

Photo: www.GarrettHamilton.com



†

SOME INTAKE SYSTEMS ARE NOT LEGAL FOR SALE OR USE ON ANY POLLUTION CONTROLLED MOTOR VEHICLE IN CALIFORNIA OR STATES ADOPTING CALIFORNIA EMISSION PROCEDURES.

See knfilters.com for CARB status on each part for a specific vehicle

See page 175 for specifications regarding emissions standards and CARB regulations.



REPLACES OE AIR BOX



ROTO-MOLDED HIGH-FLOW INTAKE TUBE



DRYCHARGER® INSTALLED  
(Where applicable)

## AIRCHARGER® INTAKE SYSTEMS – SPORT ATV

APPLICATION	YEAR	PART #	EST. HP GAIN†	EXTRA FILTER
Honda TRX450R <sup>1</sup>	04-05	63-1127*	+ 3 hp <sup>1</sup>	RU-4960XD
Kawasaki KFX450R	08-09	57-1124	+ 5 hp <sup>1</sup>	RC-4630XD
Suzuki LTR450	06-08	57-1128	+ 3 hp <sup>1</sup>	RC-5182XD
Yamaha YFZ450 (Carbureted Models) <sup>1</sup>	04-09	63-1123*	+ 4 hp <sup>1</sup>	RU-4960XD

1) Jetting modifications will be necessary to obtain maximum performance.

\*Not legal for sale or use on any pollution controlled motor vehicle in California or states adopting California emission procedures. †Estimated horsepower and torque gains based on specific or similar vehicle dynamometer tests. Results will vary. See page 175 for specifications regarding emissions standards and CARB regulations and additional testing and estimated horsepower information.

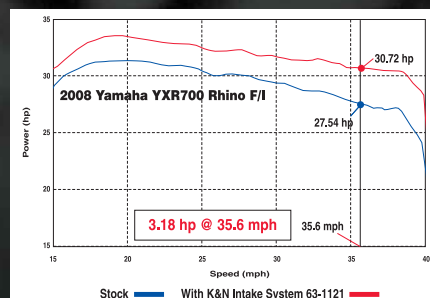

Estimated horsepower and torque gains based on specific or similar vehicle dynamometer tests. Results will vary.

# AIRCHARGER® INTAKE SYSTEMS† FOR SIDE BY SIDES

Photo: Harlen Foley

Polaris XP900



Developed for closed-course racing, these complete intake systems are designed to increase horsepower for your side by side.

- Guaranteed to increase horsepower
- Completely replaces the OE air box assembly
- Powder-coated mandrel-bent high-flow intake tube(s)\* offer low restriction
- Oversized powder-coated air box / heat shield
- Oversized K&N® "XD" High-Flow Air Filter™ for high capacity and efficiency
- Includes K&N® Drycharger® and separate crankcase breather\*
- K&N® One Year Limited Warranty

\*Where applicable



†

SOME INTAKE SYSTEMS ARE NOT LEGAL FOR SALE OR USE ON ANY POLLUTION CONTROLLED MOTOR VEHICLE IN CALIFORNIA OR STATES ADOPTING CALIFORNIA EMISSION PROCEDURES.

See [knfilters.com](http://knfilters.com) for CARB status on each part for a specific vehicle

See page 175 for specifications regarding emissions standards and CARB regulations.



**MANDREL-BENT ALUMINUM INTAKE TUBES**

(Where applicable)



**OVERSIZED "XD" AIR FILTER**



**POWDER-COATED AIR BOX AND INTAKE TUBE**

(Where applicable)

## AIRCHARGER® INTAKE SYSTEMS – SIDE BY SIDES

DESCRIPTION	YEARS	PART #	EST. HP GAIN**	REPLACEMENT AIR FILTER	REPLACEMENT DRYCHARGER®
Polaris Ranger RZR XP 900 Intake System	2011-14	57-1129	+ 2 hp**	RC-5062XD	RC-5062DK
Polaris Ranger RZR/S 800 Intake System	2008-13	57-1120	+ 3 hp**	RX-4730XD	RX-3810DK
Replacement Vent Filter for #63-1120 Intake System	2008-13	62-1300	.	.	62-1300DK
Yamaha YXR700 Rhino Intake System	2008-13	57-1121	+ 3 hp**	RC-2960XD	22-8049DK
Yamaha YXR660 Rhino Intake System	2004-07	63-1119*	+ 4 hp**	RX-3810XD	RX-3810DK
Replacement Vent Filter for #63-1119 Intake System	2004-07	62-1300	.	.	.
Yamaha YXR660 Rhino CVT Clutch Filter Kit	2004-07	RK-3920	.	.	.

\*Not legal for sale or use on any pollution controlled motor vehicle in California or states adopting California emission procedures.

\*\*Estimated horsepower and torque gains based on specific or similar vehicle dynamometer tests. Results will vary. See page 175 for specifications regarding emissions standards and CARB regulations and additional testing and estimated horsepower information.

Parts Updated Daily at [KNFILTERS.COM](http://KNFILTERS.COM) or Call 800-858-3333

AMERICAN V-TWIN

STREET

OFF-ROAD

WATERCRAFT/SNOW

SPECIALTY/ACCESSORIES

HAULER HORSEPOWER

APPAREL/SIGNAGE

K&N® PRODUCT LISTINGS



# ***WATERCRAFT/ SNOWMOBILE***



## HIGH-FLOW AIR FILTERS™

- Cotton media is designed to provide low restriction resulting in increased horsepower & torque
- Pleated media offers a large surface area, for high-capacity in extreme conditions
- Constructed with ultra-strong molded pliable rubber flanges which absorb vibration and allow for secure attachment
- Flanges can be stretched up to 1/16" (1.5mm) to fit in-between sizes
- K&N® One Year Limited Warranty



## WRENCH-OFF® OIL FILTERS

- 17mm hex nut for easy wrench-off® in hard to reach places\*
- Pre-drilled for safety wire attachment\*
- Premium synthetic blend media provides outstanding filtration at high flow rates
- High-performance anti-drainback valve\*
- Heavy duty canister construction

\*where applicable



## OTHER PRODUCTS FOR WATERCRAFT

### RACING FLAME ARRESTORS

– FOR PERSONAL WATERCRAFT –



### CARBURETOR ADAPTORS

– FOR PERSONAL WATERCRAFT –



# FLAME ARRESTORS FOR PERSONAL WATERCRAFT

Built for personal watercraft racing, these marine approved flame arrestors are designed to legally increase performance on your PWC.

- Epoxy-coated aluminum wire mesh backfire screen resists corrosion
- Polished stainless steel top plates provide resistance to salt water
- Marine approved and meets US Coast Guard standards
- Use with K&N® Drycharger® filter wrap to limit water from reaching flame arrestor



Macc Racing - Chris MacCluggage

Legal in California only for racing vehicles which may never be used, registered or licensed upon a highway.



**FLAME ARRESTOR  
#59-2046 INSTALLED**



**FLAME ARRESTOR  
#59-2040RR INSTALLED**



**FLAME ARRESTOR  
#59-2045 INSTALLED**

## DRYCHARGER® FLAME ARRESTOR WRAPS

The hydrophobic nature of our polyester Drycharger® wraps limits the amount of water that reaches the flame arrestor. K&N® filter wraps are designed to repel water, but will not seal against complete submersion.

FITS PART #	SIZE	RED #	BLUE #
59-2000	4 1/2 x 7 x 2	22-2000PR	22-2000PL
59-2015	4 1/2 x 7 x 3 tapered	22-2015PR	22-2015PL
59-2020, 59-2860	4 1/2 x 7 x 3	22-2020PR	22-2020PL
59-2030	Round conical 6" tall	22-2030PR	22-2030PL
59-2040 (R, RK, RR)	Round conical 4" tall	22-2040PR	22-2040PL
59-2870, 59-2890, 59-2900	5 1/2 x 9 x 2 1/2 oval	22-2840PR	22-2840PL
59-2910, 59-2840R	5 1/2 x 9 x 2 1/2 oval	22-2840PR	22-2840PL
59-2042R (RK)	Round conical 2 1/2" tall	22-2042PR	



**PART NUMBER  
22-2040PL**



**PART NUMBER  
22-2042PR**

# FLAME ARRESTORS FOR PERSONAL WATERCRAFT

## WATERCRAFT FLAME ARRESTORS

### OVAL - STRAIGHT FLANGE

FLANGE	BASE	TOP	HEIGHT	FLAME ARRESTOR	DRYCHARGER®
2"	4 1/2" x 7"	4 1/2" x 7"	3"	59-2020	22-2020*
2 3/4"	4 1/2" x 7"	4 1/2" x 7"	2"	59-2000	22-2000*
2 3/4"	4 1/2" x 7"	4 1/2" x 7"	3"	59-2860	22-2020*



PART NUMBER  
59-2000

### OVAL - 40° ANGLED FLANGE

FLANGE	BASE	TOP	HEIGHT	FLAME ARRESTOR	DRYCHARGER®
2 3/4", 40°	4 1/2" x 7"	4 1/2" x 7"	3"	59-2010	22-2020*



PART NUMBER  
59-2010

### OVAL BASE, OVAL TOP - 40° ANGLED FLANGE

FLANGE	BASE	TOP	HEIGHT	FLAME ARRESTOR	DRYCHARGER®
2 3/4", 40°	4 1/2" x 7"	4" x 6 1/4"	3"	59-2015	22-2015*



PART NUMBER  
59-2015

### ROUND TAPERED

FLANGE	BASE	TOP	HEIGHT	FLAME ARRESTOR	DRYCHARGER®
3 3/4"	5 1/4"	3"	6"	59-2030	22-2030*



PART NUMBER  
59-2030

### "D" SHAPED

FLANGE	BASE	TOP	HEIGHT	COLOR	FLAME ARRESTOR	DRYCHARGER®
2 3/4"	4 1/2"	3"	4"	Stainless	59-2040	22-2040*



PART NUMBER  
59-2040

### OVAL - DUAL FLANGE

FLANGE	CENTER TO CENTER	BASE	TOP	HEIGHT	FLAME ARRESTOR	DRYCHARGER®
2 3/4"	4 1/16"	5 1/2" x 9"	5 1/2" x 9"	2"	59-2830	.
2 3/4"	4 1/4"	5 1/2" x 9"	5 1/2" x 9"	2"	59-2880	.
2 3/4"	3 13/16"	5 1/2" x 9"	5 1/2" x 9"	2 1/2"	59-2910	22-2840*
2 3/4"	4 1/16"	5 1/2" x 9"	5 1/2" x 9"	2 1/2"	59-2840	22-2840*
2 3/4"	4 1/4"	5 1/2" x 9"	5 1/2" x 9"	2 1/2"	59-2870	22-2840*
2 3/4"	4 3/4"	5 1/2" x 9"	5 1/2" x 9"	2 1/2"	59-2890	22-2840*
2 3/4"	4 3/4"	5 1/2" x 9"	5 1/2" x 9"	2 1/2"	59-2900	22-2840*



PART NUMBER  
59-2910

## WATERCRAFT FLAME ARRESTORS - FOR RACING ONLY

### ROUND TAPERED - FOR RACING ONLY

FLANGE	BASE	TOP	HEIGHT	FLAME ARRESTOR	DRYCHARGER®
2 3/4"	4"	3 1/2"	2 1/4"	59-2045	59-2045DK
2 3/4"	4"	3 1/2"	2 3/4"	59-2046	22-2042PR

PART NUMBER  
59-2046



### "D" SHAPED - FOR RACING ONLY

FLANGE	BASE	TOP	HEIGHT	COLOR	FLAME ARRESTOR	DRYCHARGER®
2 3/4"	4 1/2"	3 1/2"	2 1/2"	Black	59-2042RK	22-2042PR
2 3/4"	4 1/2"	3 1/2"	2 1/2"	Chrome	59-2042R	22-2042PR
2 3/4"	4 1/2"	3"	4"	Black	59-2040RK	22-2040*
2 3/4"	4 1/2"	3"	4"	Red	59-2040RR	22-2040*
2 3/4"	4 1/2"	3"	4"	Stainless	59-2040R	22-2040*

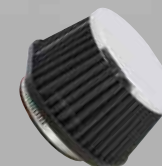

PART NUMBER  
59-2042R

### OVAL - DUAL FLANGE

FLANGE	CENTER TO CENTER	BASE	TOP	HEIGHT	FLAME ARRESTOR	DRYCHARGER®
2 3/4"	4 1/16"	5 1/2" x 9"	5 1/2" x 9"	2 1/2"	59-2840R	22-2840*



PART NUMBER  
59-2840R

\*Add "PL" to end of part number for blue Drycharger®, or add "PR" to end of part number for red Drycharger®

# FLAME ARRESTOR ADAPTERS FOR PERSONAL WATERCRAFT

## WATERCRAFT FLAME ARRESTOR ADAPTERS



**PART NUMBER**  
85-9291

STYLE 1 CARB ADAPTOR	FLANGE SIZE	VENTURI DIAMETER	BOLT CIRCLE DIAMETER	INCLUDED MOUNTING HARDWARE	PART #
2 bolt Keihin 28M	2 3/4" OD	1.645" ID	2.65"	(2) 6 mm-1.00x105 mm SS bolts	85-9265
Keihin 38/40/42	2 3/4" OD	1.965" ID	2.65"	(2) 6 mm-1.00x105 mm SS bolts	85-9291



**PART NUMBER**  
85-9496

STYLE 2 CARB ADAPTOR	FLANGE SIZE	VENTURI DIAMETER	BOLT CIRCLE DIAMETER	INCLUDED MOUNTING HARDWARE	PART #
Mikuni 38mm w/oil Inj.	2 3/4" OD	1.625" ID	2.165"	(3) 6 mm-1.00x20 mm SS bolts (1) 90° vent, 1/8" hose	85-9394*
Yamaha (Mikuni44)	2 3/4" OD	1.845" ID	2.50"	(4) 6 mm-1.00x20 mm SS bolts (2) 90° vents, 1/8" hose	85-9496*



**PART NUMBER**  
85-9329

STYLE 3 CARB ADAPTOR	FLANGE SIZE	VENTURI DIAMETER	BOLT CIRCLE DIAMETER	INCLUDED MOUNTING HARDWARE	PART #
Keihin 40-31	2 3/4" OD	1.845" ID	2.65"	(2) 6 mm-1.00x105 mm SS bolts	85-9231
Mikuni BN38/37-B1	2 3/4" OD	1.960" ID	2.568"	(2) 6 mm-1.00x20 mm SS bolts	85-9294
Mikuni 28/34/38	2 3/4" OD	1.625" ID	2.165"	(3) 6 mm-1.00x20 mm SS bolts	85-9329
Mikuni 44mm	2 3/4" OD	1.845" ID	2.50"	(4) 6 mm-1.00x20 mm SS bolts	85-9445
Mikuni BN46	2 3/4" OD	1.960" ID	2.50"	(4) 6 mm-1.00x20 mm SS bolts	85-9446

**PART NUMBER**  
85-9001

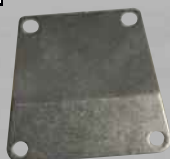

STYLE 4 - CARBURETOR BRACKET (USE WITH 85-9294 OR 85-9329)	PART #
Sea Doo XP,HX,SPX. Use with adaptor to prevent intake manifold from cracking. Use one per vessel.	85-9000
Sea Doo XP800,GTX. Use with adaptor to prevent intake manifold from cracking. Use one per vessel.	85-9001

**PART NUMBER**  
85-9388



STYLE 5 CARB ADAPTOR	FLANGE SIZE	VENTURI DIAMETER	BOLT CIRCLE DIAMETER	INCLUDED MOUNTING HARDWARE	PART #
38MM, w/cable bracket	2 3/4" OD	1.625" ID	2.165"	(3) 6 mm-1.00x20 mm SS bolts	85-9388

**PART NUMBER**  
85-9491



STYLE 6 CARB ADAPTOR	FLANGE SIZE	VENTURI DIAMETER	BOLT CIRCLE DIAMETER	INCLUDED MOUNTING HARDWARE	PART #
Yamaha VXR 650 Mikuni 44	2"	1.845" ID	2.50"	(4) 6 mm-1.00x20 mm SS bolts (2) 90° vents, 1/8" hose	85-9491

**PART NUMBER**  
85-9287



STYLE 7 CARB ADAPTOR	FLANGE SIZE	VENTURI DIAMETER	BOLT CIRCLE DIAMETER	INCLUDED MOUNTING HARDWARE	PART #
Kawasaki X2 28mm Keihin	2 3/4" OD	1.645" ID	2.65"	(2) 6 mm-1.00x105 mm SS bolts	85-9287

\*Uses a two piece design to assure that mounting bolts cannot come loose

# PERFORMANCE OIL FILTERS FOR PERSONAL WATERCRAFT

Photo: Anna Glennon-Jet Girls Racing

Optima Racing – Glen Jung



Designed to be compatible with both of today's premium synthetic and traditional style oils, the affixed 17mm hex nut can allow for quick and easy oil changes inside a hard to reach watercraft hull.

- 17mm hex nut for easy wrench-off®\*
- Pre-drilled for safety wire attachment\*
- Premium synthetic blend media provides outstanding filtration at high flow rates
- High-performance anti-drainback valve\*
- Heavy duty canister construction

\*Where applicable



## WATERCRAFT OIL FILTERS - Visit [knfilters.com](http://knfilters.com) for additional product listings

HONDA	SIZE	YEAR	PART #	SEA DOO CONTINUED	SIZE	YEAR	PART #
ARX1200T3 Aquatrax F-12/R-12	1235	2002-07	<b>KN-204</b>	Islandia SE	1494	2007-08	<b>KN-556</b>
ARX1200T3D Aquatrax F-12X GPScape	1235	2005-07	<b>KN-204</b>	RXP/RXT	1494	2005-13	<b>KN-556</b>
ARX1500N3 Aquatrax F-15	1470	2009	<b>KN-204</b>	Speedster Wake	1494	2006-09	<b>KN-556</b>
ARX1500T3 Aquatrax F-15X	1470	2008-09	<b>KN-204</b>	Sportster SCIC	1494	2005	<b>KN-556</b>
<b>KAWASAKI</b>				Wake	1494	2005-13	<b>KN-556</b>
JT1200 STX-12F	1176	2003-06	<b>KN-204</b>	GTR 215	1503	2014-15	<b>KN-556</b>
JT1200 STX-12F	1176	2007	<b>KN-303</b>	GTS 130	1503	2014-15	<b>KN-556</b>
JT1500 STX-15F	1493	2004-09	<b>KN-204</b>	GTX 155/Limited 215/iS260	1503	2014-15	<b>KN-556</b>
JT1500 STX	1498	2010	<b>KN-204</b>	RXP-X 260	1503	2014-15	<b>KN-556</b>
JT1500 STX-15F	1498	2010-11	<b>KN-204</b>	RXT 260/X 260	1503	2014-15	<b>KN-556</b>
JT1500 STX-15F	1498	2012	<b>KN-116</b>	Wake 155/Pro 215	1503	2014-15	<b>KN-556</b>
JT1500 STX-15F	1498	2013-14	<b>KN-204</b>	<b>YAMAHA</b>			
JT1500 Ultra 260 X/LX	1498	2010	<b>KN-204</b>	FAT1100 212SS/212X	998	2008-09	<b>KN-204</b>
JT1500 Ultra 300 LX/X	1498	2013	<b>KN-204</b>	FRT1100 AR210 Eng 1	998	2006-07	<b>KN-303</b>
JT1500 Ultra 310LX/R/X/SE	1498	2014	<b>KN-204</b>	FRT1100 AR210 Eng 1	998	2008-09	<b>KN-204</b>
JT1500 Ultra LX	1498	2010-11	<b>KN-204</b>	FRT1100 SR210/SX210	998	2006-07	<b>KN-303</b>
JT1500 Ultra LX	1498	2012	<b>KN-116</b>	FRT1100 SX210	998	2008	<b>KN-204</b>
JT1500 Ultra LX	1498	2013-14	<b>KN-204</b>	FX1000 WaveRunner	998	2005-07	<b>KN-303</b>
Ultra 300 LX/X	1498	2011-12	<b>KN-204</b>	FX1000 WaveRunner	998	2008	<b>KN-204</b>
JT1500 STX	1500	2009	<b>KN-204</b>	SRT1000 AR230/SR230/SX230	998	2003-05	<b>KN-303</b>
JT1500 Ultra 250X	1500	2007-08	<b>KN-204</b>	SRT1100 SR230 H.O.	998	2005-06	<b>KN-303</b>
JT1500 Ultra 260 LX	1500	2009	<b>KN-204</b>	SXT1100 232 Limited Eng 1	998	2008-09	<b>KN-204</b>
JT1500 Ultra 260 X	1500	2009	<b>KN-204</b>	SXT1100 AR230 H.O. Eng 1	998	2007	<b>KN-303</b>
JT1500 Ultra LX	1500	2007-09	<b>KN-204</b>	SXT1100 AR230 H.O. Eng 1	998	2008-09	<b>KN-204</b>
<b>SEA DOO</b>				SXT1100 SR230/SX230 H.O.	998	2007	<b>KN-303</b>
GTX 4-Tec	1484	2002-04	<b>KN-556</b>	SXT1100 SX230 H.O.	998	2008-09	<b>KN-204</b>
150 Speedster	1494	2009	<b>KN-556</b>	VX1100 WaveRunner	998	2005-07	<b>KN-303</b>
180 Challenger	1494	2009	<b>KN-556</b>	VX1100 WaveRunner	998	2008	<b>KN-204</b>
200 Speedster 430HP	1494	2009	<b>KN-556</b>	SRT1000 AR230	1000	2006	<b>KN-303</b>
205 Utopia SE	1494	2009	<b>KN-556</b>	SXT1100 232 Limited S	1100	2009	<b>KN-204</b>
230 Challenger/Wake	1494	2007-08	<b>KN-556</b>	VX1100 WaveRunner	1100	2009-14	<b>KN-204</b>
GTI 130, 155, Limited, SE, STD	1494	2006-14	<b>KN-556</b>	GX1800 FZR	1800	2011	<b>KN-204</b>
GTX	1494	2003-13	<b>KN-556</b>				

AMERICAN V-TWIN

STREET

OFF-ROAD

WATERCRAFT/  
SNOW

SPECIALTY/ACCESSORIES

HAULER HORSEPOWER

APPAREL/SIGNAGE

K&N® PRODUCT LISTINGS

# HIGH FLOW AIR FILTERS™

## SPECIALTY CLAMP-ON AIR FILTERS FOR SNOWMOBILES

K&N® clamp-on racing filters provide the added airflow your sled needs to perform even better.

- Pleated media offers a large surface area for low restriction, resulting in improved throttle response
- Constructed with ultra-strong molded pliable rubber flanges which absorb vibration and allow for secure attachment
- Flanges can be stretched up to 1/16" (1.5mm) to fit in-between sizes
- K&N® Snowcharger® filter wrap available for use in extreme conditions



Legal in California only for racing vehicles which may never be used, registered or licensed upon a highway.



**PLEATED DESIGN**

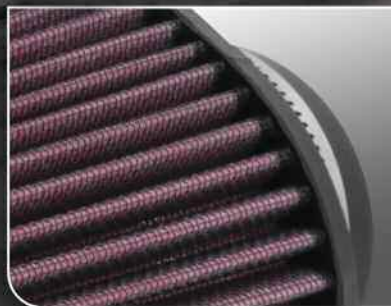

**MOLDED RUBBER FLANGE**



**SNOWCHARGER®  
INSTALLED**

### CLAMP-ON SNOWMOBILE AIR FILTERS - See page 152 for additional product listings

MOUNTING FLANGE	INSIDE DIAMETER	FILTER BASE SIZE	FILTER TOP SIZE	FILTER LENGTH	FLANGE ANGLE	PART #	SNOWCHARGER PART #
2 7/16"	3 3/4"	3 3/4"	3"	6"	20°	SN-2510	SN-2510PK
	3 3/4"	3 3/4"	3"	5"	20°	SN-2520	SN-2520PK
	3 3/4"	3 3/4"	3"	4"	20°	SN-2530	SN-2530PK
	3 3/4" x 4"	3 1/2" x 2 1/2"	3 1/2" x 2 1/2"	5"	20°	SN-2540	SN-2540PK
	3 3/4" x 4"	3 1/2" x 2 1/2"	3 1/2" x 2 1/2"	6"	20°	SN-2550	SN-2550PK
	3 3/4" x 4"	3 1/2" x 2 1/2"	3 1/2" x 2 1/2"	7"	20°	SN-2560	SN-2560DK
2 3/4"	3 1/2"	3 1/2"	2"	5"	•	SN-2570	SN-2570PK
	4 1/2"	4 1/2"	3"	4"	•	SN-2580	SN-2580PK
	4"	4"	3"	5"	10°	SN-2590	SN-2590PK
	4"	4"	3"	6"	10°	SN-2600	SN-2620PK
	4"	4"	3"	6"	20°	SN-2620	SN-2620PK
	4"	4"	3"	6"	20°	SN-2620	SN-2620PK

Mikuni VM30-34 carburetors use filters with a 2 1/4" I.D. flange. Mikuni VM36-38 carburetors use filters with a 2 7/16" I.D. flange. Mikuni VM40-44 carburetors use filters with a 2 3/4" I.D. flange.

# PERFORMANCE OIL FILTERS FOR SNOWMOBILES

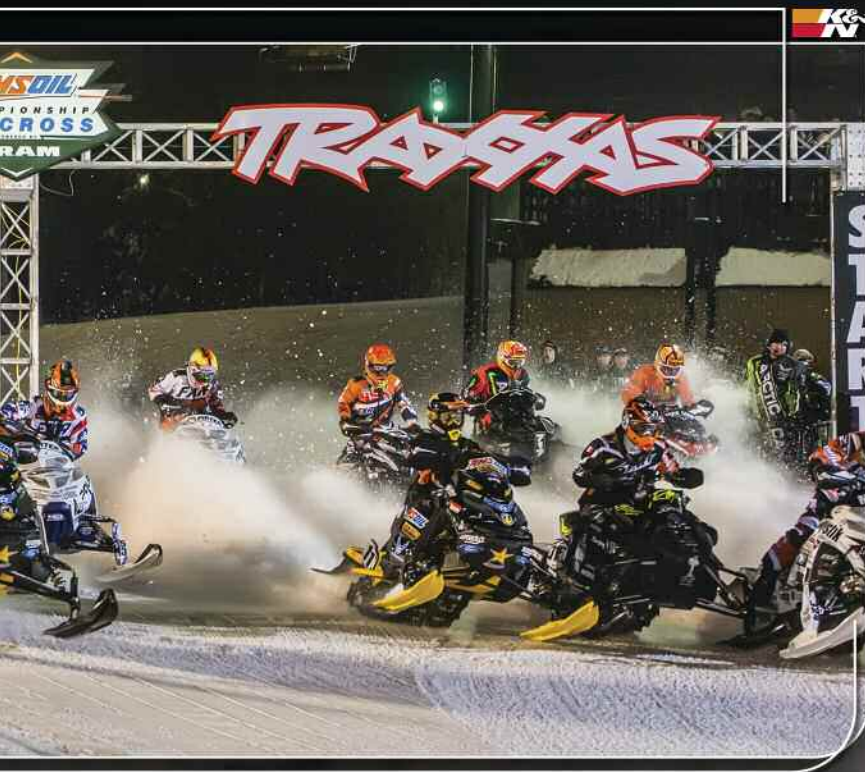

Designed to be compatible with both of today's premium synthetic and traditional style oils, the affixed 17mm hex nut can allow for quick and easy oil changes inside a hard to reach engine compartment.

- 17mm hex nut for easy wrench-off\*
- Pre-drilled for safety wire attachment\*
- Premium synthetic blend media provides outstanding filtration at high flow rates
- High-performance anti-drainback valve\*
- Heavy duty canister construction

\*Where applicable



## SNOWMOBILE OIL FILTERS - Visit [knfilters.com](http://knfilters.com) for additional product listings

POLARIS	SIZE	YEAR	PART #	YAMAHA CONTINUED	SIZE	YEAR	PART #
Frontier Classic	684	2003-04	<b>KN-196</b>	RS90LTGT Vector LTX GT	973	2008-10	<b>KN-147</b>
Frontier Classic/Touring	784	2003-05	<b>KN-196</b>	RS90R RS Vector ER	973	2009-09	<b>KN-147</b>
<b>SKI DOO</b>				RST90 RS Venture	973	2010-15	<b>KN-147</b>
Expedition Sport TUV V-800	799	2007-08	<b>KN-152</b>	VK10 RS Viking Professional	973	2008-15	<b>KN-147</b>
Legend Touring V-800	800	2007-09	<b>KN-152</b>	RX10GT Apex GT	977	2006-10	<b>KN-204</b>
Legend Trail V-800	800	2007-08	<b>KN-152</b>	RX10M Apex Mountain	977	2006-07	<b>KN-204</b>
Skandic V-800 SWT	806	2007-09	<b>KN-152</b>	RXW10 Attak	977	2006-07	<b>KN-204</b>
Skandic V-800 Tundra	806	2007-07	<b>KN-152</b>	FX10 Nytro	998	2008-13	<b>KN-147</b>
Expedition TUV V-1000	1000	2005-06	<b>KN-556</b>	FX10MT Nytro MTX	998	2008-10	<b>KN-147</b>
Legend V-1000 GT SE SPORT	1000	2004-05	<b>KN-556</b>	FX10RTR Nytro RTX	998	2008-10	<b>KN-147</b>
<b>YAMAHA</b>				RX10PS Apex SE	998	2011-15	<b>KN-204</b>
PZ50GT Phazer GT	499	2007-14	<b>KN-147</b>	RX10PX Apex XTX	998	2011-15	<b>KN-204</b>
PZ50MT Phazer Mountain Lite	499	2007-07	<b>KN-147</b>	RX10R Apex	998	2008-15	<b>KN-204</b>
PZ50MT Phazer MTX	499	2008-15	<b>KN-147</b>	RX10R Apex ER	998	2006-07	<b>KN-204</b>
PZ50RTX Phazer RTX	499	2008-15	<b>KN-147</b>	RX10 RX-1	1000	2003-05	<b>KN-303</b>
PZ50VT Venture Lite	499	2007-14	<b>KN-147</b>	RX10LT Apex LTX	1000	2008-10	<b>KN-204</b>
PZ50XT Phazer XTX	499	2014-15	<b>KN-147</b>	RX10LTGT Apex LTX GT	1000	2008-10	<b>KN-204</b>
RPZ50 Venture MP	499	2013-15	<b>KN-147</b>	RX10LTGTA Apex LTX GT 40th Anniv	1000	2008-08	<b>KN-204</b>
PZ50 Phazer	500	2007-09	<b>KN-147</b>	RX10M RX-1 Mountain	1000	2005-05	<b>KN-303</b>
RS90M RS Vector Mountain	953	2005-07	<b>KN-147</b>	RX10MS Apex Mountain SE	1000	2007-07	<b>KN-204</b>
RS90N Nytro	953	2006-07	<b>KN-147</b>	RX10MT Apex MTX	1000	2008-10	<b>KN-204</b>
RS90R RS Vector ER	953	2005-07	<b>KN-147</b>	RX10RS RX-1 ER LE	1000	2003-05	<b>KN-303</b>
RSG90 RS Rage	953	2005-07	<b>KN-147</b>	FX10M FX Nytro MTX 153	1049	2011-14	<b>KN-147</b>
RST90 RS Venture GT	953	2005-14	<b>KN-147</b>	FX10M FX Nytro MTX 162	1049	2011-14	<b>KN-147</b>
VK10 VK Professional	953	2006-07	<b>KN-147</b>	FX10RTR Nytro RTX	1049	2011-13	<b>KN-147</b>
RS90 RS Vector	973	2006-08	<b>KN-147</b>	FX10XT FX Nytro XTX 1.75	1049	2013-14	<b>KN-147</b>
RS90GT Vector GT	973	2008-11	<b>KN-147</b>	FX10XT Nytro XTX	1049	2009-12	<b>KN-147</b>
RS90GT Vector GT	973	2013-13	<b>KN-147</b>	RS10 RS Venture TF	1049	2013-14	<b>KN-147</b>
RS90LT Vector LTX	973	2008-09	<b>KN-147</b>	RS90LTGT Vector LTX GT	1049	2011-14	<b>KN-147</b>
				SR Viper LTX RTX XTX SE	1049	2014	<b>KN-147</b>

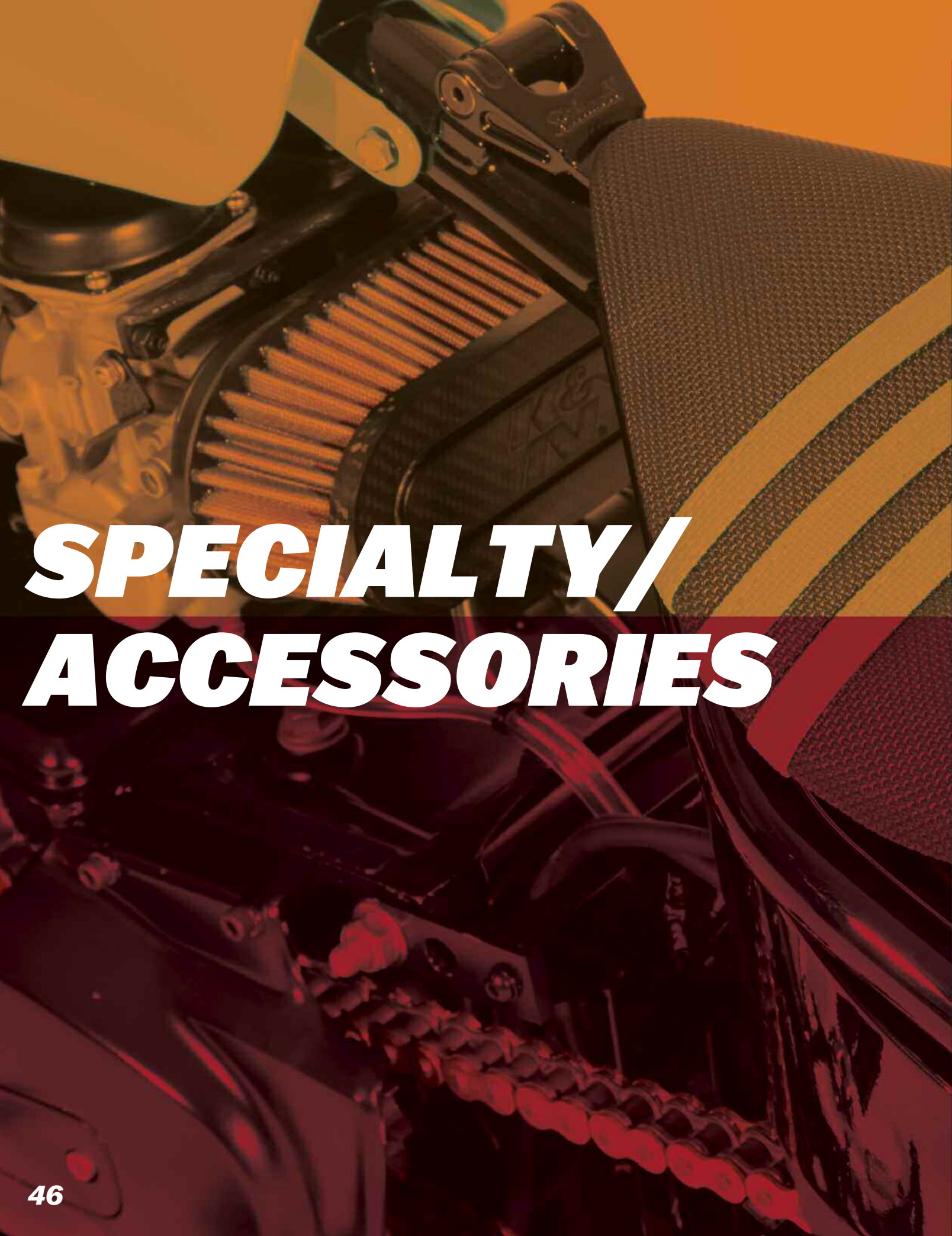

***SPECIALTY/  
ACCESSORIES***



## SPECIALTY AIR FILTERS

- Designed to clamp on to different sized intake tubes, velocity stacks, carburetors or throttle bodies
- Many applications available depending on diameter, angle or offset
- Designed to provide added airflow for your bike for increased performance
- Pleated media offers a large surface area, resulting in low restriction and excellent throttle response
- Constructed with ultra-strong molded pliable rubber flanges which absorb vibration and allow for secure attachment



## AIR FILTER WRAPS

- Designed to offer added protection from wet weather, extreme elements and extended service intervals compared to exposed air filters
- Stops small dirt particles yet adds little restriction to the airflow of the filter
- Available in many different sizes and a variety of colors of universal or custom fit applications
- Made from durable, specially treated polyester micro-weave material containing uniform micron openings
- Designed to be run dry and can be cleaned with K&N® PowerKLEEN™
- Double-stitched elastic openings ensure proper fitment



## OTHER PRODUCTS FOR SPECIALTY VEHICLES

### KART AIRBOXES AND AIR FILTERS



### CRANKCASE VENT BREATHERS



### ACCESSORIES



Legal in California only for racing vehicles which may never be used, registered or licensed for use upon a highway.

# **SPECIALTY AIR FILTERS**

## **DESIGNED TO INCREASE HORSEPOWER**

### **CARBON FIBER TOP SPECIALTY AIR FILTERS**

Carbon fiber provides incredible strength with minimal weight. Carbon fiber provides 1/3 less weight than conventional filter top construction material. Smooth, glass-like finish provides the ultimate in fit and finish as well as function and performance.

**CARBON FIBER TOP AIR FILTERS HAVE  
PART NUMBERS THAT BEGIN WITH "RP" OR "RF"**

**PRODUCT LISTINGS CAN BE FOUND ON PAGES 152-169**



### **TITANIUM TOP SPECIALTY AIR FILTERS**

When it comes to exotic race materials, titanium is well known for its lightweight and increased strength to weight ratio.

**TITANIUM TOP AIR FILTERS HAVE  
PART NUMBERS THAT BEGIN WITH "RT"**

**PRODUCT LISTINGS CAN BE FOUND ON PAGES 152-169**



### **XSTREAM® TOP SPECIALTY AIR FILTERS**

K&N® patented Xstream® racing air filters take performance to the next level with innovative K&N® airflow technology. Xstream® air filters provide outstanding airflow and increased filtration area over a standard K&N® air filter. Standard tapered or reversed tapered styles available.

K&N® XStream® Series Air Filter. U.S. Patent Number: D401,597

**XSTREAM® TOP AIR FILTERS HAVE  
PART NUMBERS THAT BEGIN WITH "RX"**

**PRODUCT LISTINGS CAN BE FOUND ON PAGES 152-169**



### **INVERTED TOP SPECIALTY AIR FILTERS**

A unique approach to filter design and concept, with a filter top that actually inverts, dropping into the cylinder of the filter. Surface area is greatly increased and designed to provide more filtration than any other comparably sized product. With three color choices, you can now customize your intake.

**INVERTED TOP AIR FILTERS HAVE  
PART NUMBERS THAT BEGIN WITH "RR" OR "RG"**

**PRODUCT LISTINGS CAN BE FOUND ON PAGES 152-169**

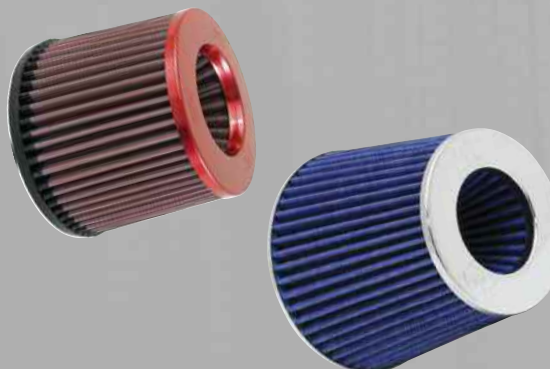

These products are not street legal on vehicles with regulated emission control systems unless used as a direct replacement air filter for a street legal intake system

# AIR FILTER WRAPS FOR ADDED PROTECTION

## **PRECHARGER® AIR FILTER WRAPS**

K&N® Prechargers® are a specially designed filter wrap made to extend the service interval of your K&N® air filter when used in very dusty conditions.

- Made from durable polyester micro-weave material containing uniform micron openings
- Stops small dirt particles, yet adds little restriction to the airflow of the filter
- Designed to be run dry and can be cleaned with K&N® filter cleaner
- Double stitched elastic openings assure that the Precharger® will stay in place
- Custom made to fit each application and available in a variety of colors



## **DRYCHARGER® AIR FILTER WRAPS**

K&N® Drychargers® are designed to prevent splashes of water or mud from saturating your K&N® air filter.

- Fits and functions exactly the same as the K&N® Precharger® except for being pre-treated with a proprietary hydrophobic process
- Manufactured from a durable polyester micro-weave material
- Stops small dirt particles, yet adds little restriction to the airflow of the filter
- Please be aware the Drycharger® is water repellent, not waterproof and depending on conditions as well as usage the water repellent treatment is good for 1 to 2 years



## **PRE-CLEANER AIR FILTER WRAPS**

Developed for only the dustiest of conditions, the K&N® pre-cleaner is a specially designed foam filter wrap made to extend the service interval of your K&N® air filter. Made from large, open cell foam, the pre-cleaner will trap dust and dirt, yet add only a small amount of restriction to the airflow of your filter.

- Custom made to fit specific applications
- Also sold in universal cut-to-fit sizes
- Red pre-cleaners are designed to be used with foam filter oil (purchased locally), pre-cleaners must be cleaned with K&N® cleaner or soap and water



AMERICAN V-TWIN

STREET

OFF-ROAD

WATERCRAFT/SNOW

SPECIALTY/  
ACCESSORIES

HAULER HORSEPOWER

APPAREL/SIGNAGE

K&N® PRODUCT LISTINGS

# CRANKCASE VENT BREATHERS

## MULTIPLE STYLES AND SIZES AVAILABLE

Steel base crankcase vent filters have vent tubes added to their base. Filters consist of a one piece design with a rubber or chrome top. Filters with mounting studs can be mounted remotely, but require vent hoses and clamps. Filters mounted direct can be pressed into rubber grommets in valve covers. Base plates are chrome plated with zinc tubes.

Rubber base crankcase vent filters are designed to clamp directly to metal or plastic tubing, or to push into rubber breather grommets. Ideal for engines, transmissions, oil and gas tanks on racing vehicles. Metal shields and top plates are chrome plated for beauty and durability.



#62-1090 installed with stud mount



**CHROME PLATED BASE  
PLATE WITH ZINC TUBE**



**CLAMP-ON  
RUBBER FLANGE**



**#62-1600 AVAILABLE IN  
MULTIPLE COLORS<sup>1</sup>**

### CRANKCASE VENT BREATHERS - Visit [knfilters.com](http://knfilters.com) for additional product listings

FLANGE I.D. (RUBBER BASE)	DIAMETER	HEIGHT	RUBBER	CHROME	CARBON FIBER
3/8" or 1/2"	2"	1 3/4"	•	62-1600 <sup>1</sup>	•
1/2"	2"	1 1/2"	•	62-1330	•
5/8"	2"	1 1/2"	•	62-1340	•
3/4"	2"	1 1/2"	•	62-1360	•
1"	2"	1 1/2"	•	62-1370	•
1" Push-On	2"	1 1/2"	•	62-1220	•
FLANGE O.D. (STEEL BASE)	DIAMETER	HEIGHT	RUBBER	CHROME	CHROME W/STUD
3/8"	2"	1 1/2"	62-1000	•	62-1090
1/2"	2"	1 1/2"	62-1010	62-1015	62-1100
1/2"	2"	3"	62-1250	•	62-1300
1/2"	3"	2"	62-1050	62-1140	•
5/8"	2"	1 1/2"	62-1020	•	62-1110
3/4"	2"	1 1/2"	62-1030	•	62-1120

1) Available in three colors. Add "BL" to end of part number for blue, "RD" for red, or "WT" for white

Legal in California only for racing vehicles which may never be used, registered or licensed for use upon a highway. These filters are not applicable, nor intended for use on aircraft. CAUTION: The use of these atmosphere vented breather systems are not recommended for computer controlled vehicles, as it will result in erratic operation and damage to the engine.

### IN-LINE FUEL FILTERS

#### 5/32" FLANGES

1 3/16" body dia. by 2 3/16" overall length (1 1/4" filter body length). Nylon mesh filter element.

#### DESCRIPTION

Single pack

12 pack

PART #

81-0291

81-0290

PART NUMBER  
81-0291



#### 1/4" FLANGES

5/8" body dia. by 2 1/8" overall length (1 5/16" filter body length). Sintered brass filter element.

#### DESCRIPTION

Single pack

12 pack

PART #

81-0221

81-0220

PART NUMBER  
81-0221



#### 1/4" FLANGES

1 5/16" body dia. by 1 3/4" overall length (3/4" filter body length). Stainless steel mesh filter element.

#### DESCRIPTION

Single pack

12 pack

PART #

81-0231

81-0230

PART NUMBER  
81-0231

#### 5/16" FLANGES

1 1/2" body dia. by 1 3/4" overall length (3/4" filter body length). Stainless steel mesh filter element.

#### DESCRIPTION

Single pack

12 pack

PART #

81-0241

81-0240

PART NUMBER  
81-0241

#### 5/16" FLANGES

1 5/16" body dia. by 2 1/8" overall length (1 1/4" filter body length). Polymer treated paper filter element.

#### DESCRIPTION

Single pack

PART #

81-0261

PART NUMBER  
81-0261

### FUEL LINE "T" FITTING

High flow, durable, lightweight, easy to use. One size fits 1/4" to 3/8" I.D. hose.

#### DESCRIPTION

Packed 12 per card

Packed 1 per card

PART#

81-0270

81-0271

PART NUMBER  
81-0271



### VELOCITY STACK AIR FILTER ADAPTOR

Lightweight nylon 6/6 construction. Fits 41mm Keihin CR flat slide carbs.

#### DESCRIPTION

53mm Long - Uses any 2 7/16" Flange K&N Air Filter

PART#

85-3000

PART NUMBER  
85-3000



### REINFORCED RUBBER WASHERS

The answer to mechanical vibrations. Made of 1/8" thick reinforced neoprene rubber. Ideal for thin panels, fenders, number plates, air cleaner lids and other items that need to be rubber mounted.

#### DESCRIPTION

1) 1" O.D., 1/4" hole (12 - 10 packs per card)

1) 1" O.D., 1/4" hole (single 10 pack)

2) 1 1/4" O.D., 5/16" hole (12 - 8 packs per card)

2) 1 1/4" O.D., 5/16" hole (single 8 pack)

PART#

81-0150

81-0151

81-0160

81-0161



PART NUMBER  
81-0151

PART NUMBER  
81-0161

# PERFORMANCE AIR BOX FOR KARTS

Since more & more kart racing organizations like IKF & SKUSA require the use of an air box/silencer, K&N® now offers a high-flow air box specifically built for karting that accommodates an original K&N® washable High-Flow Air Filter™.

- K&N® High-Flow Air Filters™ & kart air box/silencer are ideal for both 2- or 4-cycle karts
- K&N® kart air box encases a 2 1/2" (inside diameter) straight or 20° angled flange High-Flow Air Filter™
- Brass threaded insert built in to the end eases mounting
- Comes equipped with 23mm restrictors but 29mm restrictors are also available
- Approved by most kart racing organizations

Legal in California only for racing vehicles which may never be used, registered or licensed upon a highway.

 Alden Racing - Harry Alden



**STRAIGHT OR 20°  
ANGLED FLANGE**



**DURABLE ROTO-MOLDED  
AIR BOX**



**23MM OR 29MM  
RESTRICTORS**

## KART PERFORMANCE AIR BOX

DESCRIPTION	PART #
Air box with 23mm I.D. restrictors	RK-1000
High-Flow Air Filter™ - Straight	RU-5005
High-Flow Air Filter™ - 20° Angled	RU-5006
29 mm I.D. restrictors	85-2000
23 mm I.D. restrictors	85-2001



# HIGH-FLOW AIR FILTERS™ FOR KARTS

Alden Racing - Danny Alden



Clamp-on specialty filters are designed to provide added airflow for your kart.

- Pleated media offers a large surface area for low restriction, resulting in improved throttle response
- Constructed with ultra-strong molded pliable rubber flanges which absorb vibration and allow for secure attachment
- Flanges can be stretched up to 1/16" (1.5mm) to fit in-between sizes
- K&N® Precharger® filter wrap available to extend service intervals



## CLAMP-ON KART AIR FILTERS

### REPLACEMENT AIR FILTERS FOR HONDA GX-160 KART ENGINE

DESCRIPTION	AIR FILTER #
Replaces Honda OE part #17210-ZEI-822	HA-0201

#### 1 11/16" FLANGE MOUNT

MOUNTING FLANGE	DIAMETER/LENGTH	AIR FILTER #	PRECHARGER® #
Centered, round	3"D x 4"	RU-0200	22-8009PK
Centered, round	4"D x 2"	RU-0260	•

#### 2 1/16" FLANGE MOUNT

MOUNTING FLANGE	DIAMETER/LENGTH	AIR FILTER #	PRECHARGER® #
Centered, round	3 1/2"D x 4"	RU-0500	RU-0500PK
Centered, round	3 1/2"D x 6"	RU-0520	RU-0520PK
Centered, tapered	3 1/2"-2"D x 4"	RC-1200	RC-1200PK

#### 2 7/16" FLANGE MOUNT

MOUNTING FLANGE	DIAMETER/LENGTH	AIR FILTER #	PRECHARGER® #
Centered, round	3 1/2"D x 4"	RU-0800	RU-0500PK
Centered, round	3 1/2"D x 6"	RU-0820	RU-0520PK
20° angle, round	3 3/4"D x 4"	RU-1750	22-8011PK
20° angle, round	3 3/4"D x 6"	RU-1770	RU-1470PK
Centered, round	4 1/2"D x 4"	RU-0830	22-8012PK
Centered, tapered	4 1/2"D x 5"	RU-0840	22-8013PK
Offset, tapered	5 1/2"-4 1/2"D (top) x 4"	R-1380	•
20° angle, oval	4 1/2"-3 3/4"D x 7"	RU-1390	RU-1240PK

#### 2 3/4" FLANGE MOUNT

MOUNTING FLANGE	DIAMETER/LENGTH	AIR FILTER #	PRECHARGER® #
10° angle, round	4"D x 5"	RU-1460	RU-1460PK
Centered, round	4 1/2"D x 4"	RU-0900	22-8012PK
Centered, oval	6 1/4"-4"D x 5"	RU-1500	•

## KART AIR BOX ADAPTER

DESCRIPTION	PART #
Air filter with stainless steel end cap	RC-5004
Air filter with rubber end cap	RU-5004
Adapter for spec plenum air box silencer	85-8851

PART NUMBER  
RC-5004

Stainless Steel



PART NUMBER  
85-8851

Adapter



Legal in California only for racing vehicles which may never be used, registered or licensed upon a highway.

AMERICAN V-TWIN

STREET

OFF-ROAD

WATERCRAFT/SNOW

SPECIALTY/  
ACCESSORIES

HAULER HORSEPOWER

APPAREL/SIGNAGE

K&N® PRODUCT LISTINGS



# **HAULER HORSEPOWER**



## HIGH-FLOW AIR FILTERS™

- Designed to increase horsepower & acceleration
- Never needs to be replaced
- Washable and reusable
- 10-year/million mile limited warranty

WASHABLE  
REUSABLE  
PERFORMANCE®



## PERFORMANCE INTAKE SYSTEMS†

- Guaranteed increase in horsepower
- Improved throttle response
- Better engine sound
- Installs easily, usually in 90 minutes or less
- Black HDPE or mirror-finish aluminum intake tube\*
- 10-year/million mile limited warranty
- Won't void factory warranty

\*where applicable

†

SOME INTAKE SYSTEMS ARE NOT LEGAL FOR SALE OR USE ON ANY POLLUTION CONTROLLED MOTOR VEHICLE IN CALIFORNIA OR STATES ADOPTING CALIFORNIA EMISSION PROCEDURES.

See [knfilters.com](http://knfilters.com) for CARB status on each part for a specific vehicle



See page 175 for specifications regarding emissions standards and CARB regulations.

## WRENCH-OFF® OIL FILTERS

- Welded 1" filter nut eases removal
- High flow and high filtration
- Designed to be compatible with synthetic motor oils
- Heavy duty canister construction
- K&N® Limited Warranty



# PERFORMANCE INTAKE SYSTEMS FOR AUTOMOBILES

- Guaranteed to increase horsepower
- Washable and reusable cotton High-Flow Air Filter™
- Better engine sound
- Easy to install in 90 minutes or less
- Oversized air filter can go up to 100,000 miles between cleanings (under normal highway driving conditions)
- 10-year/million mile limited warranty



**HANDMADE**  
  
**IN THE USA**



Rockstar Performance Garage Custom 2014 Chevrolet 1500 Silverado

Photo: Rockstar Performance Garage



SOME INTAKE SYSTEMS ARE NOT LEGAL FOR SALE OR USE ON ANY POLLUTION CONTROLLED MOTOR VEHICLE IN CALIFORNIA OR STATES ADOPTING CALIFORNIA EMISSION PROCEDURES.

See [knfilters.com](http://knfilters.com) for CARB status on each part for a specific vehicle

See page 175 for specifications regarding emissions standards and CARB regulations.



**OVERSIZED WASHABLE  
HIGH-FLOW AIR FILTER™**



**VEHICLE-SPECIFIC TUBE  
AND HEAT SHIELD**  
(where applicable)



**MULTIPLE FINISHES  
AVAILABLE**

## **BLACKHAWK INDUCTION™ SYSTEMS**

Our NEW blacked out intake systems give you a stealth look along with the added performance and killer sound that comes with traditional K&N® intakes.

*Guaranteed to increase horsepower*

*Black powder-coated aluminum heat shield to isolate incoming air from engine heat and mandrel-bent high-flow aluminum intake tube*

Featuring NEW black synthetic washable air filters:

- Incredibly easy to clean – uses no oil
- Thick 3D media provides high airflow and dirt capacity



Some intake systems are not legal for sale or use on any pollution controlled motor vehicle in California or states adopting California emission procedures.

VISIT [KNFILTERS.COM](http://KNFILTERS.COM) FOR COMPLETE PRODUCT LISTINGS

# PERFORMANCE INTAKE SYSTEMS FOR AUTOMOBILES

**HIGH-FLOW INTAKE SYSTEMS - Visit [knfilters.com](http://knfilters.com) for additional product listings**

CHEVROLET	YEAR	ENGINE (LITERS)	BLACK HDPE INTAKE TUBE	NOTE	EST. HP GAIN†	ALUMINUM INTAKE TUBE	NOTE	EST. HP GAIN†
Avalanche	2009-13	5.3L	57-3070	1	+ 10 hp	77-3070KP	1	+ 10 hp
Colorado	2007-12	2.9L	63-3064-1	2	+ 9 hp	•	•	•
Colorado	2007-12	3.7L	63-3065	2	+ 11 hp	77-3065KP	2	+ 7 hp
Colorado	2015-16	3.6L	63-3088	2	+ 19 hp	77-3088KP	2	+ 10 hp
Silverado 1500/Colorado	2014	4.3L	63-3085	2	+ 10 hp	77-3085KP	2	+ 10 hp
Silverado 1500	2014-16	5.3L	63-3082	2	+ 11 hp	77-3082KP	2	+ 10 hp
Silverado 1500	2014-15	6.2L	63-3082	2	+ 11 hp	77-3082KP	2	+ 10 hp
Silverado 1500	2012-13	4.8L	63-3070	2	+ 10 hp	77-3070KP	2	+ 10 hp
Silverado 1500	2012-13	5.3L	63-3070	2	+ 10 hp	77-3070KP	2	+ 10 hp
Silverado 1500	2009-11	4.8L	63-3070	2	+ 10 hp	77-3070KP	1	+ 10 hp
Silverado 1500	2009-11	5.3L	63-3070	2	+ 10 hp	77-3070KP	1	+ 10 hp
Silverado 1500	2007-08	4.8L	57-3058	1	+ 18 hp	77-3058KP	1	+ 12 hp
Silverado 1500	2007-08	5.3L	57-3058	1	+ 18 hp	77-3058KP	1	+ 12 hp
Silverado 1500	1999-06	4.3L	57-3038	1	+ 8 hp	•	•	•
Silverado 1500	2005-06	4.8L	57-3050	1	+ 12 hp	77-3050KP	1	+ 8 hp
Silverado 1500	2005-06	5.3L	57-3050	1	+ 12 hp	77-3050KP	1	+ 8 hp
Silverado 1500	1999-04	4.8L	57-3021-1	1	+ 9 hp	77-3021KP	1	+ 8 hp
Silverado 1500	1999-04	5.3L	57-3021-1	1	+ 9 hp	77-3021KP	1	+ 8 hp
Silverado 1500 Classic	2007	4.3L	57-3038	1	+ 8 hp	•	•	•
Silverado 1500 Classic	2007	4.8L	57-3050	1	+ 12 hp	77-3050KP	1	+ 8 hp
Silverado 1500 Classic	2007	5.3L	57-3050	1	+ 12 hp	77-3050KP	1	+ 8 hp
Silverado 2500/3500 HD	2015-16	6.6L DSL	63-3087	2	+ 24 hp	77-3087KP	2	+ 20 hp
Silverado 2500/3500 HD	2011-14	6.6L DSL	57-3077	1	+ 19 hp	77-3077KP	1	+ 12 hp
Silverado 2500 HD	2007-10	6.6L DSL	57-3066	1	+ 20 hp	•	•	•
Silverado 2500 HD	2001-06	8.1L	57-3030-1	1	+ 17 hp	•	•	•
Silverado 2500 HD	2006	6.6L DSL	57-3000	1	+ 15 hp	•	•	•
Silverado 2500 HD	2005	6.6L DSL	57-3000	1,3	+ 15 hp	•	•	•
Silverado 2500 HD	2005	6.6L DSL	57-3047	1,4	+ 20 hp	77-3047KP	1,4	+ 20 hp
Silverado 2500 HD	2004	6.6L DSL	57-3034	1,5	+ 16 hp	77-3034KP	1,5	+ 13 hp
Silverado 2500 HD	2004	6.6L DSL	57-3047	1,6	+ 20 hp	77-3047KP	1,6	+ 20 hp
Silverado 2500 HD	2001-03	6.6L	57-3034	1	+ 16 hp	77-3034KP	1	+ 13 hp
Silverado 2500 HD Classic	2007	6.6L DSL	57-3000	1	+ 15 hp	•	•	•
Silverado 3500	2006	6.6L DSL	57-3000	1	+ 15 hp	•	•	•
Silverado 3500	2005	6.6L DSL	57-3000	1,3	+ 15 hp	•	•	•
Silverado 3500	2005	6.6L DSL	57-3047	1,4	+ 20 hp	77-3047KP	1,4	+ 20 hp
Silverado 3500	2004	6.6L DSL	57-3034	1,5	+ 16 hp	77-3034KP	1,5	+ 13 hp
Silverado 3500	2004	6.6L DSL	57-3047	1,6	+ 20 hp	77-3047KP	1,6	+ 20 hp
Silverado 3500	2001-03	6.6L DSL	57-3034	1	+ 16 hp	77-3034KP	1	+ 13 hp
Silverado 3500 Classic	2007	6.6L DSL	57-3000	1	+ 15 hp	•	•	•
Silverado 3500 HD	2007-10	6.6L DSL	57-3066	1	+ 20 hp	•	•	•
Suburban 1500	2009-14	5.3L	57-3070	1	+ 10 hp	77-3070KP	1	+ 10 hp
Suburban 1500	2015-16	5.3L	63-3082	2	+ 11 hp	77-3082KP	2	+ 12 hp
Tahoe	2015-16	5.3L	63-3082	2	+ 11 hp	77-3082KP	2	+ 10 hp
Tahoe	2009-14	5.3L	57-3070	1	+ 10 hp	77-3070KP	1	+ 10 hp
Tahoe	2007-08	5.3L	57-3058	1	+ 18 hp	77-3058KP	1	+ 12 hp
Tahoe	2005-06	5.3L	57-3050	1	+ 12 hp	77-3050KP	1	+ 8 hp
Tahoe	2000-04	5.3L	57-3023-1	1	+ 14 hp	77-3023KP	1	+ 8 hp
<b>DODGE</b>								
Durango	2011-15	3.6L	•	•	•	77-1560KTK	2	+ 11 hp
Durango	2011-15	5.7L	63-1563	2	+ 17 hp	77-1563KP	2	+ 15 hp
Ram 1500 Pickup	2002-10	3.7L	57-1537	1	+ 7 hp	•	•	•
Ram 1500 Pickup	2002-10	4.7L	57-1529	1	+ 9 hp	77-1529KP	1	+ 7 hp
Ram 1500 Pickup	2009-11	5.7L	57-1561	1	+ 16 hp	77-1561KP	1	+ 10 hp
Ram 1500 Pickup	2003-08	5.7L	57-1533	1	+ 10 hp	77-1533KP	1	+ 8 hp
Ram 1500 Pickup	2002-03	5.9L	57-1530-1	1	+ 9 hp	•	•	•
Ram 2500 Pickup	2010	6.7L DSL	63-1562	2	+ 8 hp	•	•	•
Ram 2500 Pickup	2007-09	6.7L DSL	57-1557	1	+ 21 hp	•	•	•
Ram 2500 Pickup	2003-08	5.7L	57-1533	1	+ 10 hp	77-1533KP	1	+ 8 hp
Ram 2500 Pickup	2003-07	5.9L DSL	57-1532	1	+ 11 hp	•	•	•

1) Street Legal in 50 States 2) Street Legal in most states, not legal for sale or use in California or other states with similar emission control regulations 3) w/Round Filter 4) w/Panel Filter 5) LB7 6) LLY 7) Exc. 2 Valve VIN W NOTE: Prefix 57 and 63 usually incorporate black molded high density polyethylene tubes. Prefix 69 and 77 incorporate aluminum tubes. †Estimated horsepower and torque gains based on specific or similar vehicle dynamometer tests. Results will vary. See page 175 for specifications regarding emissions standards and CARB regulations and additional testing and estimated horsepower information.

# PERFORMANCE INTAKE SYSTEMS FOR AUTOMOBILES

**HIGH-FLOW INTAKE SYSTEMS - Visit [knfilters.com](http://knfilters.com) for additional product listings**

DODGE CONTINUED	YEAR	ENGINE (LITERS)	BLACK HDPE INTAKE TUBE	NOTE	EST. HP GAIN†	ALUMINUM INTAKE TUBE	NOTE	EST. HP GAIN†
Ram 2500/3500 Pickup	1994-02	5.9L DSL	<b>57-1525</b>	1	+ 9 hp	•	•	•
Ram 3500 Pickup	2010	6.7L DSL	<b>63-1562</b>	2	+ 8 hp	•	•	•
Ram 3500 Pickup	2007-09	6.7L DSL	<b>57-1557</b>	1	+ 21 hp	•	•	•
Ram 3500 Pickup	2003-08	5.7L	<b>57-1533</b>	1	+ 10 hp	<b>77-1533KP</b>	1	+ 8 hp
Ram 3500 Pickup	2003-07	5.9L DSL	<b>57-1532</b>	1	+ 11 hp	•	•	•
<b>FORD</b>								
Expedition	2015	3.5L ECO	<b>63-2595</b>	2	+ 7 hp	•	•	•
Expedition	2011-14	5.4L	<b>63-2575</b>	2	+ 11 hp	•	•	•
Expedition	2007-10	5.4L	<b>57-2575</b>	1	+ 11 hp	•	•	•
Explorer	2014-15	2.0L	•	•	•	<b>77-2587KS</b>	2	+ 11 h
F150	2015	5.0L	<b>57-2591</b>	1	+ 13 hp	<b>77-2591KP</b>	1	+ 14 hp
F150	2015-16	2.7L	<b>57-2593</b>	1	+ 19 hp	•	•	•
F150	2015-16	3.5L	<b>63-2592</b>	2	+ 23 hp	•	•	•
F150	2011-14	3.5L	<b>57-2583</b>	1	+ 11 hp	•	•	•
F150	2011-14	5.0L	<b>57-2581</b>	1	+ 12 hp	<b>77-2581KP</b>	1	+ 10 hp
F150	2012-14	3.7L	•	•	•	<b>77-2585KS</b>	2	+ 12 hp
F150	2011-12	6.2L	<b>57-2584</b>	1	+ 27 hp	<b>77-2584KP</b>	1	+ 19 hp
F150	2009-10	5.4L	<b>57-2575</b>	1	+ 11 hp	•	•	•
F150	2009-10	4.6L	<b>63-2580</b>	1,7	+ 16 hp	<b>77-2580KP</b>	1,7	+ 15 hp
F150	2004-08	5.4L	<b>57-2556</b>	1	+ 15 hp	<b>77-2556KP</b>	1	+ 10 hp
F150	2007-08	4.6L	<b>57-2574</b>	1	+ 10 hp	•	•	•
F150	2004-05	4.6L	<b>57-2557</b>	1	+ 8 hp	<b>77-2557KP</b>	1	+ 9 hp
F150	1997-04	4.2L	<b>57-2550</b>	1	+ 8 hp	<b>77-2550KP</b>	1	+ 6 hp
F150	1997-03	4.6L/5.4L	<b>57-2541</b>	1	+ 13 hp	<b>77-2514KP</b>	1	+ 10 hp
F150 Harley Davidson	2002-03	5.4L	<b>57-2549</b>	1	+ 16 hp	•	•	•
F150 Harley Davidson	2000-01	5.4L	<b>57-2514-4</b>	1	+ 10 hp	<b>77-2514KP</b>	1	+ 10 hp
F150 Heritage	2004	5.4L	<b>57-2541</b>	1	+ 13 hp	•	•	•
F150 Heritage	2004	4.6L	<b>57-2541</b>	1	+ 13 hp	<b>77-2514KP</b>	1	+ 10 hp
F150 SVT Raptor	2010-14	6.2L	•	•	•	<b>77-2579KTK</b>	2	+ 20 hp
F150 SVT Raptor	2010	5.4L	<b>57-2575</b>	1	+ 11 hp	•	•	•
F250/350 Super Duty	2015-16	6.2L	•	•	•	<b>77-2582KTK</b>	2	+ 14 hp
F250/350 Super Duty	2011-14	6.2L	<b>63-2582</b>	1	+ 12 hp	<b>77-2582KTK</b>	1	+ 14 hp
F250 Super Duty	2008-10	6.4L DSL	<b>57-2576</b>	1	+ 16 hp	•	•	•
F250 Super Duty	2003-07	6.0L DSL	<b>57-2546-1</b>	1	+ 16 hp	•	•	•
F250 Super Duty	2000-03	7.3L DSL	<b>57-2530</b>	1	+ 15 hp	•	•	•
F350 Super Duty	2008-10	6.4L DSL	<b>57-2576</b>	1	+ 16 hp	•	•	•
F350 Super Duty	2003-07	6.0L DSL	<b>57-2546-1</b>	1	+ 16 hp	•	•	•
F350 Super Duty	2000-03	7.3L DSL	<b>57-2530</b>	1	+ 15 hp	•	•	•
Ranger	2004-11	4.0L	<b>57-2561</b>	1	+ 13 hp	<b>77-2561KP</b>	1	+ 11 hp
Ranger	2004-08	3.0L	<b>57-2560</b>	1	+ 10 hp	•	•	•
<b>GMC</b>								
Canyon	2015-16	3.6L	<b>63-3088</b>	2	+ 19 hp	<b>77-3088KP</b>	2	+ 10 hp
Canyon	2007-12	2.9L	<b>63-3064-1</b>	2	+ 9 hp	•	•	•
Canyon	2007-12	3.7L	<b>63-3065</b>	2	+ 11 hp	<b>77-3065KP</b>	2	+ 7 hp
Sierra 1500/Canyon	2014	4.3L	<b>63-3085</b>	2	+ 10 hp	<b>77-3085KP</b>	2	+ 10 hp
Sierra 1500	2014-16	5.3L	<b>63-3082</b>	2	+ 11 hp	<b>77-3082KP</b>	2	+ 10 hp
Sierra 1500	2014-15	6.2L	<b>63-3082</b>	2	+ 11 hp	<b>77-3082KP</b>	2	+ 10 hp
Sierra 1500	2009-13	4.8L	<b>57-3070</b>	1	+ 10 hp	<b>77-3070KP</b>	1	+ 10 hp
Sierra 1500	2009-13	5.3L	<b>57-3070</b>	1	+ 10 hp	<b>77-3070KP</b>	1	+ 10 hp
Sierra 1500	2007-08	4.8L	<b>57-3058</b>	1	+ 18 hp	<b>77-3058KP</b>	1	+ 12 hp
Sierra 1500	2007-08	5.3L	<b>57-3058</b>	1	+ 18 hp	<b>77-3058KP</b>	1	+ 12 hp
Sierra 1500	1999-06	4.3L	<b>57-3038</b>	1	+ 8 hp	•	•	•
Sierra 1500	2005-06	4.8L	<b>57-3050</b>	1	+ 12 hp	<b>77-3050KP</b>	1	+ 8 hp
Sierra 1500	2005-06	5.3L	<b>57-3050</b>	1	+ 12 hp	<b>77-3050KP</b>	1	+ 8 hp
Sierra 1500	1999-04	4.8L/5.3L	<b>57-3021-1</b>	1	+ 9 hp	<b>77-3021KP</b>	1	+ 8 hp
Sierra 1500 Classic	2007	4.8L	<b>57-3050</b>	1	+ 12 hp	<b>77-3050KP</b>	1	+ 8 hp
Sierra 1500 Classic	2007	5.3L	<b>57-3050</b>	1	+ 12 hp	<b>77-3050KP</b>	1	+ 8 hp

1) Street Legal in 50 States 2) Street Legal in most states, not legal for sale or use in California or other states with similar emission control regulations  
3) w/Round Filter 4) w/Panel Filter 5) LB7 6) LLY 7) Exc. 2 Valve VIN W NOTE: Prefix 57 and 63 usually incorporate black molded high density polyethylene tubes. Prefix 69 and 77 incorporate aluminum tubes. †Estimated horsepower and torque gains based on specific or similar vehicle dynamometer tests. Results will vary. See page 175 for specifications regarding emissions standards and CARB regulations and additional testing and estimated horsepower information.

# PERFORMANCE INTAKE SYSTEMS FOR AUTOMOBILES

**HIGH-FLOW INTAKE SYSTEMS - Visit [knfilters.com](http://knfilters.com) for additional product listings**

GMC CONTINUED	YEAR	ENGINE (LITERS)	BLACK HDPE INTAKE TUBE	NOTE	EST. HP GAIN†	ALUMINUM INTAKE TUBE	NOTE	EST. HP GAIN†
Sierra 2500/3500 HD	2015-16	6.6L DSL	<b>63-3087</b>	2	+ 24 hp	<b>77-3087KP</b>	2	+ 20 hp
Sierra 2500/3500HD	2011-14	6.6L DSL	<b>57-3077</b>	1	+ 19 hp	<b>77-3077KP</b>	1	+ 12 hp
Sierra 2500 HD	2007-10	6.6L DSL	<b>57-3066</b>	1	+ 20 hp	•	•	•
Sierra 2500 HD	2001-06	8.1L	<b>57-3030-1</b>	1	+ 17 hp	•	•	•
Sierra 2500 HD	2006	6.6L DSL	<b>57-3000</b>	1	+ 15 hp	•	•	•
Sierra 2500 HD	2005	6.6L DSL	<b>57-3000</b>	1,3	+ 15 hp	•	•	•
Sierra 2500 HD	2005	6.6L DSL	<b>57-3047</b>	1,4	+ 20 hp	<b>77-3047KP</b>	1,4	+ 20 hp
Sierra 2500 HD	2004	6.6L DSL	<b>57-3034</b>	1,5	+ 16 hp	<b>77-3034KP</b>	1,5	+ 13 hp
Sierra 2500 HD	2004	6.6L DSL	<b>57-3047</b>	1,6	+ 20 hp	<b>77-3047KP</b>	1,6	+ 20 hp
Sierra 2500 HD Classic	2007	6.6L DSL	<b>57-3000</b>	1	+ 15 hp	•	•	•
Sierra 3500	2006	6.6L DSL	<b>57-3000</b>	1	+ 15 hp	•	•	•
Sierra 3500	2005	6.6L DSL	<b>57-3000</b>	1,3	+ 15 hp	•	•	•
Sierra 3500	2005	6.6L DSL	<b>57-3047</b>	1,4	+ 20 hp	<b>77-3047KP</b>	1,4	+ 20 hp
Sierra 3500	2004	6.6L DSL	<b>57-3034</b>	1,5	+ 16 hp	<b>77-3034KP</b>	1,5	+ 13 hp
Sierra 3500	2004	6.6L DSL	<b>57-3047</b>	1,6	+ 20 hp	<b>77-3047KP</b>	1,6	+ 20 hp
Sierra 3500 Classic	2007	6.6L DSL	<b>57-3000</b>	1	+ 15 hp	•	•	•
Sierra 3500 HD	2007-10	6.6L DSL	<b>57-3066</b>	1	+ 20 hp	•	•	•
Yukon	2015-16	5.3L	<b>63-3082</b>	2	+ 11 hp	<b>77-3082KP</b>	2	+ 10 hp
Yukon	2009-14	5.3L	<b>57-3070</b>	1	+ 10 hp	<b>77-3070KP</b>	1	+ 10 hp
Yukon	2007-08	5.3L	<b>57-3058</b>	1	+ 18 hp	<b>77-3058KP</b>	1	+ 12 hp
Yukon	2005-06	5.3L	<b>57-3050</b>	1	+ 12 hp	<b>77-3050KP</b>	1	+ 8 hp
<b>JEEP</b>								
Cherokee	2014-16	3.2L	<b>63-1569</b>	2	+ 8 hp	<b>77-1569KS</b>	2	+ 8 hp
Grand Cherokee	2012-15	6.4L	•	•	•	<b>77-1567KS</b>	2	+ 28 hp
Grand Cherokee	2011-15	3.6L	•	•	•	<b>77-1560KTK</b>	2	+ 11 hp
Grand Cherokee	2011-14	5.7L	<b>63-1563</b>	2	+ 17 hp	<b>77-1563KP</b>	2	+ 15 hp
Grand Cherokee	2005-10	3.7L	<b>57-1545</b>	1	+ 8 hp	<b>77-1545KP</b>	1	+ 7 hp
Wrangler	2012-15	3.6L	<b>63-1566</b>	2	+ 12 hp	<b>77-1566KP</b>	2	+ 10 hp
Wrangler	2007-11	3.8L	<b>57-1553</b>	1	+ 8 hp	<b>77-1553KP</b>	1	+ 8 hp
Wrangler	1997-06	4.0L	<b>57-1514-1</b>	1	+ 12 hp	•	•	•
<b>NISSAN</b>								
Titan	2012-14	5.6L	<b>63-6012</b>	2	+ 11 hp	<b>77-6012KP</b>	2	+ 7 hp
Titan	2004-11	5.6L	<b>57-6012</b>	1	+ 11 hp	<b>77-6012KP</b>	1	+ 7 hp
<b>RAM</b>								
1500	2015	3.0L ECODSL	<b>63-1571</b>	2	+ 11 hp	•	•	•
1500	2012-15	5.7L	<b>63-1561</b>	2	+ 16 hp	<b>77-1561KP</b>	2	+ 10 hp
1500	2012	4.7L	<b>63-1529</b>	2	+ 9 hp	<b>77-1529KP</b>	2	+ 7 hp
1500	2011	3.7L	<b>63-1537</b>	2	+ 7 hp	•	•	•
1500	2011	4.7L	<b>57-1529</b>	1	+ 9 hp	<b>77-1529KP</b>	1	+ 7 hp
1500	2011	5.7L	<b>63-1561</b>	2	+ 16 hp	<b>77-1561KP</b>	1	+ 10 hp
2500/3500	2013-16	6.7L DSL	<b>63-1568</b>	2	+ 15 hp	•	•	•
2500	2013-16	5.7L	<b>63-1561</b>	2	+ 16 hp	<b>77-1561KP</b>	2	+ 10 hp
2500/3500	2014-15	6.4L	•	•	•	<b>77-1568KTK</b>	2	+ 16 hp
2500/3500	2011-12	6.7L DSL	<b>63-1562</b>	2	+ 8 hp	•	•	•
<b>TOYOTA</b>								
4 Runner	2015	4.0L	<b>63-9034</b>	2	+ 12 hp	<b>77-9034KP</b>	2	+ 11 hp
4 Runner	2010-14	4.0L	<b>63-9034</b>	2	+ 12 hp	<b>77-9034KP</b>	2	+ 11 hp
FJ Cruiser	2010-14	4.0L	<b>63-9034</b>	2	+ 12 hp	<b>77-9034KP</b>	2	+ 11 hp
Tacoma	2005-16	2.7L	<b>63-9026</b>	2	+ 7 hp	<b>77-9026KP</b>	2	+ 6 hp
Tacoma	2012-15	4.0L	<b>63-9037</b>	2	+ 9 hp	<b>77-9037KP</b>	2	+ 8 hp
Tacoma	2005-11	4.0L	<b>63-9025</b>	2	+ 10 hp	<b>77-9025KP</b>	2	+ 10 hp
Tacoma	1999-04	3.4L	<b>57-9015-1</b>	1	+ 9 hp	<b>77-9015KP</b>	1	+ 9 hp
Tacoma	2000-04	2.4/2.7L	<b>57-9016-1</b>	1	+ 6 hp	<b>77-9016KP</b>	1	+ 5 hp
Tundra	2010-15	4.6L	<b>63-9035</b>	2	+ 14 hp	<b>77-9035KP</b>	2	+ 10 hp
Tundra	2014-15	4.7L/5.7L	<b>57-9036</b>	1	+ 6 hp	<b>77-9036KP</b>	2	+ 7 hp
Tundra	2007-11	5.7L	<b>63-9031-1</b>	2	+ 13 hp	<b>77-9031-1KP</b>	2	+ 13 hp
Tundra	2007-09	4.7L	<b>63-9032-1</b>	2	+ 8 hp	<b>77-9032-1KP</b>	2	+ 9 hp

1) Street Legal in 50 States 2) Street Legal in most states, not legal for sale or use in California or other states with similar emission control regulations  
3) w/Round Filter 4) w/Panel Filter 5) LB7 6) LLY 7) Exc. 2 Valve VIN W NOTE: Prefix 57 and 63 usually incorporate black molded high density polyethylene tubes. Prefix 69 and 77 incorporate aluminum tubes. †Estimated horsepower and torque gains based on specific or similar vehicle dynamometer tests. Results will vary. See page 175 for specifications regarding emissions standards and CARB regulations and additional testing and estimated horsepower information.

# HIGH-FLOW AIR FILTERS™ FOR AUTOMOBILES

- Designed to increase horsepower and acceleration
- Washable and reusable
- 10-year/million mile limited warranty
- Drops into your factory air box in 5 minutes
- Up to 50,000 miles between cleanings (under normal highway driving conditions)



**HIGH-FLOW WASHABLE  
COTTON MEDIA**



**DURABLE URETHANE OR  
PLASTISOL FRAME**



**DROPS EASILY INTO YOUR  
FACTORY AIR BOX**

## HIGH-FLOW AIR AND OIL FILTERS - Visit [knfilters.com](http://knfilters.com) for additional product listings

CHEVROLET	YEAR(S)	ENGINE (LITERS)	AIR FILTER	OIL FILTER	NOTE
Avalanche	2007-13	5.3L	33-2129	HP-1017	
Avalanche	2007-09	6.0L	33-2135	HP-1017	
Canyon	2015-16	2.5L/3.6L	33-5030	HP-1017	
Colorado	2008-12	2.9L	33-2408	HP-1007	
Colorado	2008-12	3.7L	33-2408	HP-2006	
Colorado	2009-12	5.3L	33-2408	HP-1017	
Silverado 1500	2014-15	4.3L	33-2129	HP-2011	
Silverado 1500	2014-15	5.3L	33-2129	HP-2011	
Silverado 1500	2014-15	6.2L	33-2135	HP-2011	
Silverado 1500	2001-13	4.3L	33-2129	HP-1001	

CHEVROLET CONT.	YEAR(S)	ENGINE (LITERS)	AIR FILTER	OIL FILTER	NOTE
Silverado 1500	2007-13	4.8/5.3L	33-2129	HP-1017	
Silverado 1500	2009-11	6.2L	33-2135	HP-1017	
Silverado 1500	2003-06	4.8/5.3L	33-2129	HP-1007	
Silverado 1500	1999-02	4.8/5.3L	33-2129	HP-2006	
Silverado 1500	1999-00	4.3L	33-2129	HP-2001	
Silverado 1500 Clsc	2007	4.3L	33-2129	HP-1001	
Silverado 1500 Clsc	2007	4.8/5.3L	33-2129	HP-1017	
Silverado 2500 HD/3500	2007-15	6.0L	33-2135	HP-1017	
Silverado 2500 HD/3500	2011-15	6.6L DSL	33-2466	HP-3003	
Silverado 2500 HD/3500	2006-10	6.6L DSL	E-0781	HP-3003	

1) w/Panel Air Filter 2) w/Round Air Filter 3) 3/4 thread Oil Filter 4) 22mm Thread Oil Filter 5) Spin On Oil Filter

# WRENCH-OFF® OIL FILTERS FOR AUTOMOBILES

Falkner Livingston Racing - Micky Dymond



- Welded 1" filter nut eases removal
- High flow and high filtration
- Designed to be compatible with synthetic motor oils
- Heavy duty canister construction
- K&N® Limited Warranty

**WRENCH-OFF**  
PERFORMANCE OIL FILTERS



**PRE-DRILLED NUT FOR  
EASY REMOVAL**



**DURABLE CANISTER  
CONSTRUCTION**



**CARTRIDGE OIL FILTERS  
ALSO AVAILABLE**

**HIGH-FLOW AIR AND OIL FILTERS - Visit [knfilters.com](http://knfilters.com) for additional product listings**

CHEVROLET CONT.	YEAR(S)	ENGINE (LITERS)	AIR FILTER	OIL FILTER	NOTE
Silverado 2500 HD/3500	2001-06	8.1L	33-2135	HP-1011	
Silverado 2500 HD/3500	2003-06	6.0L	33-2135	HP-1007	
Silverado 2500 HD/3500	2005	6.6L DSL	33-2135	HP-3003 1	
Silverado 2500 HD/3500	2005	6.6L DSL	E-0781	HP-3003 2	
Silverado 2500 HD/3500	2001-04	6.6L DSL	33-2135	HP-3003	
Silverado 2500 HD/3500	2001-02	6.0L	33-2135	HP-2006	
Silv 2500 HD/3500 Clsc	2007	8.1L	33-2135	HP-1011	
Silv 2500 HD/3500 Clsc	2007	6.0L	33-2135	HP-1017	
Silv 2500 HD/3500 Clsc	2007	6.6L DSL	E-0781	HP-3003	
Suburban 1500	2007-16	5.3L	33-2129	HP-1017	

CHEVROLET CONT.	YEAR(S)	ENGINE (LITERS)	AIR FILTER	OIL FILTER	NOTE
Suburban 1500	2012-13	6.0L		HP-1017	
Suburban 1500	2003-06	5.3L	33-2129	HP-1007	
Tahoe	2007-15	5.3L	33-2129	HP-1017	
Tahoe	2007-09	4.8L	33-2129	HP-1017	
Tahoe	2003-06	4.8/5.3L	33-2129	HP-1007	
Tahoe	2000-02	4.8/5.3L	33-2129	HP-2006	
TrailBlazer	2002-09	4.2L	E-1009	HP-2006	
Traverse	2011-15	3.6L	33-2394	HP-2011	
Traverse	2009-10	3.6L	33-2394	HP-1017	

**CONTINUED ON NEXT PAGE...**

1) w/Panel Air Filter 2) w/Round Air Filter 3) 3/4 thread Oil Filter 4) 22mm Thread Oil Filter 5) Spin On Oil Filter

# HIGH-FLOW AIR AND OIL FILTERS FOR AUTOMOBILES

**HIGH-FLOW AIR AND OIL FILTERS - Visit [knfilters.com](http://knfilters.com) for additional product listings**

DODGE	YEAR(S)	ENGINE (LITERS)	AIR FILTER	OIL FILTER	NOTE
Dakota	2008-10	4.7L	<b>33-2175</b>	<b>HP-2010</b>	
Durango	2015	5.7L	•	<b>HP-2010</b>	
Durango	2011-14	3.6L	<b>33-2457</b>	•	
Durango	2011-14	5.7L	<b>33-2457</b>	<b>HP-2010</b>	
Ram 1500 PU	2008-10	4.7/5.7L	<b>33-2247</b>	<b>HP-2010</b>	
Ram 1500 PU	2002-08	3.7L	<b>33-2247</b>	<b>HP-2009</b>	
Ram 1500 PU	2002-07	4.7L	<b>33-2247</b>	<b>HP-2004</b>	
Ram 1500 PU	2003-07	5.7L	<b>33-2247</b>	<b>HP-2004</b>	
Ram 2500/3500 PU	2008-10	5.7L	<b>33-2247</b>	<b>HP-2010</b>	
Ram 2500/3500 PU	2010	6.7L DSL	<b>E-0787</b>	<b>HP-4003</b>	
Ram 2500/3500 PU	2003-09	5.9L DSL	<b>E-0776</b>	<b>HP-4003</b>	
Ram 2500/3500 PU	2007-09	6.7L DSL	<b>E-0784</b>	<b>HP-4003</b>	
Ram 2500/3500 PU	2003-07	5.7L	<b>33-2247</b>	<b>HP-2004</b>	
Ram 2500/3500 PU	1994-02	5.9L DSL	<b>33-2056</b>	<b>HP-4003</b>	
Ram 2500/3500 PU	1994-02	8.0L	<b>33-2058</b>	<b>HP-2004</b>	
Ram 2500/3500 PU	1994-02	5.9L	<b>33-2084</b>	<b>HP-2004</b>	

## FORD

Excursion	2000-05	6.8L	<b>E-0945</b>	<b>HP-2010</b>	
Excursion	2003-05	6.0L DSL	<b>E-0780</b>	•	
Excursion	2000-03	7.3L DSL	<b>33-2248</b>	<b>HP-6001</b>	
Expedition	2015	3.5L	<b>33-2385</b>	<b>HP-2011</b>	
Expedition	2007-14	5.4L	<b>33-2385</b>	<b>HP-2010</b>	
Expedition	2005-06	5.4L	<b>33-2287</b>	<b>HP-2010</b>	
Expedition	1997-04	4.6/5.4L	<b>E-0945</b>	<b>HP-2010</b>	
Explorer	2011-15	3.5L	<b>33-2395</b>	<b>HP-2011</b>	
Explorer	2015	2.0L	•	<b>HP-1002</b>	
Explorer	2012-14	2.0L	<b>33-2395</b>	<b>HP-1002</b>	
Explorer	2006-10	4.6L	<b>33-2353</b>	<b>HP-2010</b>	
Explorer	2006-10	4.0L	<b>33-2366</b>	<b>HP-2010</b>	
F150	2011-15	3.5L	<b>33-2385</b>	<b>HP-2011</b>	
F150	2011-15	5.0L	<b>33-2385</b>	<b>HP-2011</b>	
F150	2015	2.7L	<b>33-2385</b>	•	
F150	2011-14	6.2L	<b>33-2385</b>	<b>HP-2010</b>	
F150	2011-14	3.7L	<b>33-2385</b>	<b>HP-2011</b>	
F150	2009-10	5.4L	<b>33-2385</b>	<b>HP-2010</b>	
F150	1997-08	4.2L	<b>E-0945</b>	<b>HP-2009</b>	
F150	2004-08	5.4L	<b>33-2287</b>	<b>HP-2010</b>	
F150	2004-08	4.6L	<b>E-0945</b>	<b>HP-2009</b>	3
F150	2004-08	4.6L	<b>E-0945</b>	<b>HP-2010</b>	4
F150	1997-03	4.6/5.4L	<b>E-0945</b>	<b>HP-2010</b>	
F150 Harley Davidson	2002-03	5.4L	<b>33-2140-1</b>	<b>HP-2010</b>	
F150 Harley Davidson	2000-01	5.4L	<b>E-0945</b>	<b>HP-2010</b>	
F150 Heritage	2004	4.6/5.4L	<b>E-0945</b>	<b>HP-2010</b>	
F150 SVT Raptor	2010-14	6.2L	<b>33-2385</b>	<b>HP-2010</b>	
F150 SVT Raptor	2010	5.4L	<b>33-2385</b>	<b>HP-2010</b>	
F250/F350 Super Duty	2011-15	6.2L	<b>33-2385</b>	<b>HP-2010</b>	
F250/F350 Super Duty	2011-15	6.7L DSL	<b>33-5010</b>	<b>HP-4005</b>	
F250/F350 Super Duty	2008-10	5.4/6.8L	<b>33-2385</b>	<b>HP-2010</b>	
F250/F350 Super Duty	2008-10	6.4L DSL	<b>E-0785</b>	•	

FORD CONT.	YEAR(S)	ENGINE (LITERS)	AIR FILTER	OIL FILTER	NOTE
F250/F350 Super Duty	2005-07	5.4L	<b>33-2287</b>	<b>HP-2010</b>	
F250/F350 Super Duty	2005-07	6.8L	<b>33-2313</b>	<b>HP-2010</b>	
F250/F350 Super Duty	2003-06	6.0L DSL	<b>E-0780</b>	•	
F250/F350 Super Duty	1999-04	5.4L	<b>E-0945</b>	<b>HP-2010</b>	
F250/F350 Super Duty	1999-04	6.8L	<b>E-0945</b>	<b>HP-2010</b>	
F250/F350 Super Duty	2000-03	7.3L DSL	<b>33-2248</b>	<b>HP-6001</b>	
Ranger	2012-15	2.5L	<b>E-0662</b>	•	
Ranger	2012-15	2.2L/3.2L DSL	<b>E-0662</b>	•	

## GMC

Canyon	2015-16	2.5L/3.6L	<b>33-5030</b>	<b>HP-1017</b>	
Canyon	2008-12	2.9L	<b>33-2408</b>	<b>HP-1007</b>	
Canyon	2008-12	3.7L	<b>33-2408</b>	<b>HP-2006</b>	
Canyon	2009-12	5.3L	<b>33-2408</b>	<b>HP-1017</b>	
Sierra	2015	5.3L	<b>33-2129</b>	<b>HP-2011</b>	
Sierra	2007	5.3L	<b>33-2129</b>	<b>HP-1017</b>	
Sierra 1500	2014-15	4.3L	<b>33-2129</b>	<b>HP-2011</b>	
Sierra 1500	2014-15	6.2L	<b>33-2135</b>	<b>HP-2011</b>	
Sierra 1500	2015	5.3L	<b>33-2129</b>	<b>HP-2011</b>	
Sierra 1500	2007-14	5.3L	<b>33-2129</b>	<b>HP-1017</b>	
Sierra 1500	2000-13	4.3L	<b>33-2129</b>	<b>HP-1001</b>	
Sierra 1500	2007-13	4.8L	<b>33-2129</b>	<b>HP-1017</b>	
Sierra 1500	2009-13	6.2L	<b>33-2135</b>	<b>HP-1017</b>	
Sierra 1500	2007-09	6.0L	<b>33-2135</b>	<b>HP-1017</b>	
Sierra 1500	2003-06	4.8/5.3L	<b>33-2129</b>	<b>HP-1007</b>	
Sierra 1500	2005-06	6.0L	<b>33-2135</b>	<b>HP-1007</b>	
Sierra 1500	1999-02	4.8/5.3L	<b>33-2129</b>	<b>HP-2006</b>	
Sierra 1500 Clsc	2007	4.3L	<b>33-2129</b>	<b>HP-1001</b>	
Sierra 1500 Clsc	2007	4.8/5.3L	<b>33-2129</b>	<b>HP-1017</b>	
Sierra 2500 HD/3500	2007-15	6.0L	<b>33-2135</b>	<b>HP-1017</b>	
Sierra 2500 HD/3500	2012-15	6.6L DSL	<b>33-2466</b>	<b>HP-3003</b>	
Sierra 2500 HD/3500	2011	6.6L DSL	<b>33-2466</b>	<b>HP-3003</b>	
Sierra 2500 HD/3500	2006-10	6.6L DSL	<b>E-0781</b>	<b>HP-3003</b>	
Sierra 2500 HD/3500	2001-06	8.1L	<b>33-2135</b>	<b>HP-1011</b>	
Sierra 2500 HD/3500	2003-06	6.0L	<b>33-2135</b>	<b>HP-1007</b>	
Sierra 2500 HD/3500	2005	6.6L DSL	<b>33-2135</b>	<b>HP-3003</b>	1
Sierra 2500 HD/3500	2005	6.6L DSL	<b>E-0781</b>	<b>HP-3003</b>	2
Sierra 2500 HD/3500	2001-04	6.6L DSL	<b>33-2135</b>	<b>HP-3003</b>	
Sierra 2500 HD/3500	2001-02	6.0L	<b>33-2135</b>	<b>HP-2006</b>	
Sier 2500 HD/3500 Clsc	2007	8.1L	<b>33-2135</b>	<b>HP-1011</b>	
Sier 2500 HD/3500 Clsc	2007	6.0L	<b>33-2135</b>	<b>HP-1017</b>	
Sier 2500 HD/3500 Clsc	2007	6.6L DSL	<b>E-0781</b>	<b>HP-3003</b>	
Terrain	2010-15	2.4L	<b>33-2439</b>	<b>PS-7000</b>	
Terrain	2013-15	3.6L	<b>33-2439</b>	<b>HP-2011</b>	
Terrain	2011-12	3.0L	<b>33-2439</b>	<b>HP-2011</b>	
Yukon	2007-15	5.3L	<b>33-2129</b>	<b>HP-1017</b>	
Yukon	2011	6.2L	<b>33-2135</b>	<b>HP-1017</b>	
Yukon	2007-09	4.8L	<b>33-2129</b>	<b>HP-1017</b>	
Yukon	2003-06	4.8/5.3L	<b>33-2129</b>	<b>HP-1007</b>	

1) w/Panel Air Filter 2) w/Round Air Filter 3) 3/4 thread Oil Filter 4) 22mm Thread Oil Filter 5) Spin On Oil Filter



# HIGH-FLOW AIR AND OIL FILTERS FOR AUTOMOBILES

**HIGH-FLOW AIR AND OIL FILTERS - Visit [knfilters.com](http://knfilters.com) for additional product listings**

GMC CONT.	YEAR(S)	ENGINE (LITERS)	AIR FILTER	OIL FILTER	NOTE
Yukon	2000-02	4.8/5.3L	<b>33-2129</b>	<b>HP-2006</b>	
Yukon XL	2015	5.3L	<b>33-2129</b>	<b>HP-1017</b>	
Yukon XL 1500	2007-14	5.3L	<b>33-2129</b>	<b>HP-1017</b>	
Yukon XL 1500	2013-14	6.2L	<b>33-2135</b>	<b>HP-1017</b>	
Yukon XL 1500	2009-11	6.2L	<b>33-2135</b>	<b>HP-1017</b>	
Yukon XL 1500	2007-09	6.0L	<b>33-2135</b>	<b>HP-1017</b>	
Yukon XL 1500	2003-06	5.3L	<b>33-2129</b>	<b>HP-1007</b>	

## JEEP

Cherokee	2014-15	3.2L	<b>33-5009</b>	•	
Cherokee	2014-15	2.4L	<b>33-5009</b>	<b>HP-1017</b>	
Grand Cherokee	2011-15	3.6L	<b>33-2457</b>	•	
Grand Cherokee	2011-15	5.7L	<b>33-2457</b>	<b>HP-2010</b>	
Grand Cherokee	2012-15	6.4L	<b>33-2457</b>	<b>HP-2010</b>	
Renegade	2014-16	1.6/2.0L DSL	<b>33-5023</b>	•	
Wrangler	2007-15	2.8L DSL	<b>33-5023</b>	•	
Wrangler	2012-15	3.6L	<b>33-2364</b>	•	
Wrangler	2007-11	3.8L	<b>33-2364</b>	<b>HP-1002</b>	
Wrangler	1998-06	4.0L	<b>33-2114</b>	<b>HP-2004</b>	
Wrangler	2003-06	2.4L	<b>33-2261</b>	<b>HP-1002</b>	
Wrangler	1998-02	2.5L	<b>33-2114</b>	<b>HP-2004</b>	

## NISSAN

Armada	2015	5.6L	•	<b>HP-1010</b>	
Armada	2005-14	5.6L	<b>33-2286</b>	<b>HP-1010</b>	
Frontier	2005-15	4.0L	<b>33-2286</b>	<b>HP-1010</b>	
Frontier	2005-14	2.5L	<b>33-2324</b>	<b>HP-1008</b>	
Frontier	1998-04	2.4L	<b>E-9233</b>	<b>HP-1010</b>	
Frontier	1999-04	3.3L	<b>33-2031-2</b>	<b>HP-1010</b>	
Titan	2015	5.6L	<b>33-2286</b>	<b>HP-1010</b>	
Titan	2012-14	5.6L	<b>33-2286</b>	<b>HP-1008</b>	
Titan	2004-11	5.6L	<b>33-2286</b>	<b>HP-1010</b>	
Xterra	2015	4.0L	•	<b>HP-1010</b>	
Xterra	2005-14	4.0L	<b>33-2286</b>	<b>HP-1010</b>	
Xterra	2000-04	3.3L	<b>33-2031-2</b>	<b>HP-1010</b>	
Xterra	2000-04	2.4L	<b>E-9233</b>	<b>HP-1010</b>	

## RAM

1500	2013-15	3.6L	<b>33-2247</b>	•	
1500	2013-15	5.7L	<b>33-2247</b>	<b>HP-1017</b>	
1500	2014-15	3.0L DSL	<b>33-2247</b>	•	
1500	2011-13	4.7L	<b>33-2247</b>	<b>HP-2010</b>	
1500	2011-12	5.7L	<b>33-2247</b>	<b>HP-2010</b>	
2500/3500	2013-15	5.7L	<b>33-2247</b>	<b>HP-1017</b>	
2500/3500	2013-15	6.7L DSL	<b>33-5005</b>	<b>HP-4003</b>	

RAM	YEAR(S)	ENGINE (LITERS)	AIR FILTER	OIL FILTER	NOTE
2500/3500	2015	6.4L	<b>33-2247</b>	•	
2500/3500	2014	6.4L	<b>33-2247</b>	<b>HP-1017</b>	
2500/3500	2011-12	5.7L	<b>33-2247</b>	<b>HP-2010</b>	
2500/3500	2011-12	6.7L DSL	<b>E-0787</b>	<b>HP-4003</b>	

## TOYOTA

4 Runner	2015	4.0L	<b>33-2438</b>	•	
4 Runner	2012-14	4.0L	<b>33-2438</b>	•	
4 Runner	2003-09	4.0L	<b>33-2281</b>	<b>HP-1002</b>	
4 Runner	2003-08	4.7L	<b>33-2144</b>	<b>HP-1002</b>	
FJ Cruiser	2010-14	4.0L	<b>33-2438</b>	•	
FJ Cruiser	2007-09	4.0L	<b>33-2281</b>	<b>HP-1002</b>	
Land Cruiser	2013-14	5.7L	<b>33-2387</b>	•	
Land Cruiser	2008-11	5.7L	<b>33-2387</b>	•	
Land Cruiser	1998-07	4.7L	<b>33-2146</b>	<b>HP-1002</b>	
Sequoia	2001-07	4.7L	<b>33-2144</b>	<b>HP-1002</b>	
Sequoia	2008-09	4.7L	<b>33-2387</b>	<b>HP-1002</b>	
Sequoia	2008-13	5.7L	<b>33-2387</b>	•	
Sequoia	2010-12	4.6L	<b>33-2387</b>	•	
Sequoia	2014-15	5.7L	<b>33-5017</b>	•	
Tacoma	2005-15	4.0L	<b>33-2281</b>	<b>HP-1002</b>	
Tacoma	2005-15	2.7L	<b>33-2306</b>	<b>HP-1002</b>	
Tacoma	1995-04	2.4/2.7L	<b>33-2050-1</b>	<b>HP-1002</b>	
Tacoma	1995-04	3.4L	<b>33-2054</b>	<b>HP-1002</b>	
Tundra	2014-15	4.6/5.7L	<b>33-5017</b>	•	
Tundra	2012-14	4.0L	<b>33-2387</b>	•	
Tundra	2007-13	5.7L	<b>33-2387</b>	•	
Tundra	2010-13	4.6L	<b>33-2387</b>	•	
Tundra	2011	4.0L	<b>33-2387</b>	<b>HP-1002</b>	5
Tundra	2005-10	4.0L	<b>33-2281</b>	<b>HP-1002</b>	
Tundra	2007-09	4.7L	<b>33-2387</b>	<b>HP-1002</b>	
Tundra	2000-06	4.7L	<b>33-2144</b>	<b>HP-1002</b>	
Tundra	2000-04	3.4L	<b>33-2144</b>	<b>HP-1002</b>	

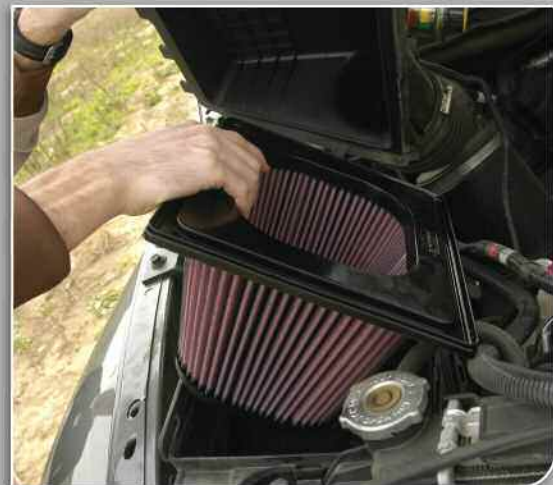

**MANY MORE AIR AND OIL FILTERS  
AVAILABLE FOR CARS AND TRUCKS AT  
[KNFILTERS.COM](http://KNFILTERS.COM)**

1) w/Panel Air Filter 2) w/Round Air Filter 3) 3/4 thread Oil Filter 4) 22mm Thread Oil Filter 5) Spin On Oil Filter

# HEAVY DUTY AIR FILTERS FOR DIESEL TRUCKS AND RVs

Our heavy duty air filters are constructed with extra strength and reinforcements to withstand the harsh conditions that can be found in commercial use. They are specially designed to withstand the extreme temperatures and pressures that can be present in large turbo diesel applications. They are also designed to avoid collapsing or losing their seal under the high levels of compression and air flow encountered in commercial environments.

**DRYFLOW**  
AIR FILTER TECHNOLOGY



## Hybrid Filtration Media

Our Hybrid air filtration media is a non-woven synthetic material designed to be used dry with no oil required. It is comprised of lofted non-woven synthetic fibers, giving the air filter high airflow/low-restriction while providing large dust holding capacities.

## Easy To Clean & Reuse - Uses No Oil

These filters are incredibly easy to clean and nearly indestructible. After you apply our special degreaser, (1 gallon bottle #99-0638), you can use pressure washers, power sprayers, or water hose nozzles to clean the filter.



K&N® truck & trailer coming soon to an event near you



## HEAVY DUTY AIR FILTER CROSS REFERENCE

K&N®	BALDWIN	CARQUEST	DONALDSON	FARR / RACOR	FLEETGUARD	FRAM	LUBER-FINER	NAPA	WIX
38-2000S*	PA4653	87818	•	400820014	•	•	•	2818	42818
38-2001S/R*	PA2721	88891	P537447	062891001	AH1104	CA7229	LAF1828	6891	46891
38-2002S/R*	PA2722	88893	P537448	062891002	AH1105	CA7230	LAF1848	6893	46893
38-2003R*	PA2723	88895	P537449	062891003	AH8505	CA7231	LAF1844	6895	46895
38-2006S*	PA3493	88748	P537454	114880003	AH1197	CA8130	LAF1934	6748	46748
38-2007S*	PA3556	88755	P537453	114500003	AH1193	CA6855	LAF2521	6755	46755
38-2008S*	PA2839	88623	P522874	•	AF25668	CA7113	LAF1839	6623	46623
38-2009R*	•	•	•	094973007	•	•	•	•	•
38-2011S*	RS3517	88744	P532966	•	AF25223	CA8193	LAF4498	6744	46744
38-2012S*	RS3518	88556	P527682	•	AF25139M	CA7140	LAF1849	6556	46556
38-2013S*	RS3548	88664	P533930	•	AF25335	CA8466	LAF3930	6664	46664
38-2014S*	PA3555	88759	P537452	114500002	AH1192	CA8129	LAF22026	6759	46759
38-2015R*	RS3539	88843	P534816	•	AF25247	CA8081	LAF4816	6843	46843
38-2016S*	RS4993	•	P613333	•	AF25708M	•	LAF5962	•	49708
38-2017S*	PA2761	88506	R804759	•	AF4697	CA6696	LAF1947	6506	46506
38-2018S*	RS3750	87455	P549644	•	AF25598	CA9009	LAF5873	2455	42455
38-2019S*	RS3530	88745	P533235	•	AF25033	CA7466	LAF1953	6745	46745
38-2020S*	RS4859	88907	P614563	•	AF26667	CA9663	LAF2032	6907	46907
38-2021R*	RS3534	88863	P534925	•	AF25248	CA8231	LAF3302	6863	46863
38-2022S*	RS3516	88842	P534096	•	AF25219	CA7727	LAF2536	6842	46842
38-2023S*	RS4634	87808	P616691	•	AF26363	CA9869	LAF5114MXM	2808	42808
38-2024S*	RS3740	88772	P540388	•	AF25435	CA8598	LAF5722	6772	46772
38-2025S*	RS4642	83126	P606720	•	AF26163M	CA9901	LAF9201	9126	49126
38-2026S*	RS4636	88870	P606503	•	AF25707	CA9346	LAF9099	6870	46870
38-2027S*	RS4862	83088	P613336	•	AF26103	CA10305	LAF6663	9088	49088
38-2028S*	PA2456	87546	P181049	•	AF891	•	LAF6453	2546	42546
38-2029S*	PA2705	88883	P153551	•	AF1968	CA3990	LAF3551	6883	46883
38-2030R*	PA2608	88868	P181186	•	AF9966	CA6918	LAF2608	6868	46868
38-2031S*	RS2863	88433	P527484	•	AF4878	CA7139	LAF1878	6433	46433
38-2032S*	PA2680	88882	P150695	•	AF1969	CA6512	LAF695	6882	46882
38-2033S*	PA3499	88904	P776157	•	AF25549	CA8003	LAF7472	6904	46904
38-2034R*	RS4572	87798	P544243	•	AF25955	CA9758	LAF6243	2798	42798
38-2035S*	RS5434	88932	P543614	•	AF27693	CA9856	LAF5633	6932	46932
38-2036R*	•	•	P614556	•	•	•	LAF4556	•	•
38-2037R*	PA2317	87961	P181008	•	AF852	CA595	LAF6918	2961	42961
38-2038R*	PA2357	87661	P181009	•	AF865	CA596	LAF6880	2661	42661
38-2039R*	PA2493	87941	P181016	•	AF1616	CA2588	LAF8494	2941	42941
38-2040R*	PA2312	87966	P181007	•	AF853	CA1581	LAF7797	2966	42966
38-2042R*	PA2732	•	P522293	•	AF4588M	CA3517	LAF1770	2610	42610
38-2043R*	•	•	P614986	•	•	•	LAF6986	•	WA10009

\*S = standard flow. R = Reverse flow. Some air filters are available in both variations. Cross references should be used for comparison of filters with similar dimensions. The user assumes all responsibility for verifying that filters are compatible with their vehicle before using these products. Damage may result if the user fails to ensure that the filter is compatible and seals properly before installing the product or operating the engine. Please call K&N's Customer Service Department at 1-877-AIR-FILTER for assistance when choosing the appropriate replacement air filter.

# HEAVY DUTY WRENCH-OFF® OIL FILTERS

## FOR DIESEL TRUCKS AND RVs



K&N® heavy duty wrench-off® oil filters have been specially designed for the high compression levels and tighter tolerances of turbo diesel engines. Our synthetic micro-glass media provides lower restriction and incredible engine protection. Add to this our thicker canister and higher burst strength and you have one serious heavy duty oil filter.



**WRENCH-OFF**  
PERFORMANCE OIL FILTERS



**STURDY 1" NUT FOR EASY REMOVAL**



**SYNTHETIC MEDIA FOR HIGH DIRT CAPACITY AND FILTRATION EFFICIENCY**



**DICHROMATE PLATED BASE PLATE WITH DOUBLE-ROLLED SEAL**

### HEAVY DUTY WRENCH-OFF® OIL FILTER CROSS REFERENCE

K&N®	BALDWIN	CARQUEST	DONALDSON	FLEETGUARD	FRAM	LUBER-FINER	NAPA	WIX
HP-8000	B495 B495-MPG B495-SS	85971 85971XD	P552100 ELF3998	LF3620 LF3671 LF9620	PH7405A PH7405	LFP2160 LFP2160XL	1971 1971XD	51971 51971XD
HP-8001	B76 B76-MPG B76-SS B7600 B7600-SS	85791 85791XD 85791XE	P553191 P554004 ELF7483 ELF7739	LF667 LF3379 LF9667 LF9691 LF9691A	PH8842 PH49A HPH49A	LFP3191 LFP3191SC LFP3191XL	1791 1791XD 1791XE	51791 51791XD 51791XE
HP-8002	B99 B99-MPG B99-SS	85792 85792XD 85792XE	P554005 P554105 ELF7405	LF691 LF691A LF3374 LF3566 LF9691 LF9691A	PH3335 HPH3335 PH3426	LFP4005 LFP4005RN LFP4005SC LFP4005XL	1792P 1792XD 1792XE	51792 51792XD 51792XE 51801
HP-8003	BD103 BD103-SS	85748 85748XD	P553000 ELF7300	LF3000 LF3639 LF9009	PH6349A HPH6349A HPH6349	LFP3000 LFP3000XL	1748 1748XD	51748 51748XD
HP-8006	BD7154	84745XD 84746XD	P559000 ELF7900	LF9031 LF9080	• •	LFP9001	7745XD 7746XD	57745XD 57746XD
HP-8017	BT427	85602	P558616 ELF7345	LF3345	PH3900	LFP3900	1602	51602
HP-8021	BT237	85459	P554407	LF699 LF787	PH977A	LFP2292	1459	51459
HP-8025	BD7250	84744XD	P550656 P552025	LF9025	PH9971 PH9971A	LFP9025	7744XD	57744XD
HP-8026	P7235	84311	P550528	LF16166	CH9549	LP2017	7311	57311
HP-8027	P7188	84215	P550761	LF3914	CH9260	LP8741	7215	57215
HP-8028	P7230	84213	P550769 ELF7690	LF16046	CH9558	LP5048	7213	57213

Cross references should be used for comparison of filters with similar dimensions. The user assumes all responsibility for verifying that filters are compatible with their vehicle before using these products. Damage may result if the user fails to ensure that the filter is compatible and seals properly before installing the product or operating the engine. Please call K&N's Customer Service Department at 1-877-AIR-FILTER for assistance when choosing the appropriate replacement oil filter.



# ***SIGNAGE / DISPLAYS***

# AUTHORIZED DEALER PROGRAM

## LET KNFILTERS.COM WORK FOR YOU

Over 1 million unique visitors each month

- Check your dealer listing, get registered, and easily look up products at [knfilters.com](http://knfilters.com)

## THE BENEFITS DON'T STOP AT REFERRALS

- Online and phone referrals direct customers to your store
- Includes new product data and application updates
- Receive a free welcome kit and sales collateral
- Includes sales literature and catalogs, price list, POP materials, banners, window clings and decals

## FREE K&N® WELCOME KIT

- Available for verified powersports dealers that currently sell K&N® products
- Includes a variety of powersports promotional display material and literature to educate your staff and customers on the benefits of K&N® products
- Kit includes K&N® powersports catalogs, sales brochure, audio training CD, mini-brochures, decals, banners and POP displays to help promote K&N® in-store sales

## K&N® AUTHORIZED DEALER DISPLAY

- Proudly displays K&N® performance filters and cleaning supplies
- Centralizes and organizes your K&N® inventory for ease of ordering
- Increases education and traffic to the complete K&N® product line
- Easy to assemble, black powder coated metal construction
- Contact your K&N® representative today to qualify

## K&N® PERFORMANCE FILTERS MAKE YOU MORE PROFIT AND YOUR JOB EASIER TO ACCOMPLISH

If your parts and service departments aren't stocking and servicing K&N® filters across the board and making conscious efforts to push them at each opportunity, you are missing out on valuable profits.



**K&N® Displays and Promotional Materials are Available to Authorized K&N® Dealers with Qualifying Stock of Both K&N® Air and Oil Filters.**

**PART NUMBER 87-3058**  
28w x 67h x 14d

# MERCHANDISING / SIGNAGE

## DISPLAYS AND POP

Teaching consumers about the benefits of K&N® products and the technology behind K&N® air filters is what influences consumers to upgrade to the best. All of our communication, advertising, displays, and catalogs are designed to communicate our straight forward and easy-to-understand product benefits



**UPGRADE TO A WASHABLE PERFORMANCE AIR FILTER!**  
**ASK ABOUT ONE FOR YOUR BIKE!**

PART NUMBER  
87-11610



**UPGRADE TO A WASHABLE PERFORMANCE AIR FILTER!**  
**ASK ABOUT ONE FOR YOUR BIKE!**

PART NUMBER  
87-11611

PART NUMBER  
87-11614



PART NUMBER  
87-1124-3



# MERCHANDISING / SIGNAGE DISPLAYS AND POP

Premium dealers use K&N® signage to increase brand recognition



PART NUMBER  
89-11918



PART NUMBER  
89-11493-16

PART NUMBER  
89-11595



PART NUMBER  
89-11824-09



PART NUMBER  
89-11917



PART NUMBER  
89-11820-1

PART NUMBER  
89-11837-1



PART NUMBER  
87-1118



## MERCHANDISING TOOLS - Visit [knfilters.com](http://knfilters.com) for complete listings

### DISPLAYS/PROMOTIONAL

Powersports Dealer Display (28"W X 67"H X 14"D)	87-3055
Air Filter Display Sportbike (11"W X 10"H X 3"D)	87-11610
Air Filter Display Cruiser (11"W X 10"H X 3"D)	87-11611
Air Intake Display (25"W X 14.5"H X 9.5"D)	89-11909-10
Air Flow Demonstrator 110V (14"W X 10.5"H X 17.25"D)	87-1124-3
Oil Filter Dispenser (22"W X 26.75"H X 6"D)	87-11614

### STORE SIGNAGE/MERCHANDISING

Authorized Dealer, 2-Sided Window Decal (11"W X 6.375"H)	89-11595
Table Tent; Air Filters and Oil Filters (8.5"W X 3"H X 3.75"D)	87-1118
Shelf Wobbler; Air Filters (4"W X 8.75"H)	89-11824-09
Shelf Wobbler; Oil Filters (4"W X 8.75"H)	89-11917
Embossed Aluminum Sign (20"W X 9"H)	89-11837-1
Double-Sided Sign, K&N® High-Flow Technology (8"H X 5"W)	89-11820-1

### PROMOTIONAL MATERIALS

2016 K&N® Wall Calendar (14"W x 10.5" H)	89-11853-16
2016 K&N® Shop Calendar (24"W X 18"H)	89-11493-16
K&N Nylon Banner (72"W X 42"H)	89-11839

### SALES LITERATURE

K&N Sales Card; Oil Filters	89-11918
Powersports Mini-Brochure	89-11548
Automotive Mini-Brochure	89-11803-06
2016 Powersports Catalog	89-11483-16
2016 Automotive Catalog	89-11482-16

### DECALS

K&N® Logo Decal; AMA; Black (3"W X 1.3"H)	89-16191
K&N® Logo Decal; AMA; White (3"W X 1.3"H)	89-16190
K&N® Logo Decal; Black (4.5" X 1.375"H)	89-0020-05
K&N® Logo Decal; White (4.5" X 1.375"H)	89-0030-05
K&N® Logo Decal; White, Die-Cut (6"W X 2"H)	89-16180
K&N® Logo Decal; Black, Die-Cut (6"W X 2"H)	89-16181
K&N® Logo Decal; Black (9"W X 4"H)	89-16182-1
K&N® Logo Decal; Trailer; Black (30"W X 15"H)	89-16167-1

### ACCESSORIES

K&N® Patch, White with Black Outline (4.25"W X 1.75"H)	89-0019
--	---------

AMERICAN V-TWIN

STREET

OFF-ROAD

WATERCRAFT/SNOW

SPECIALTY/ACCESSORIES

HAULER HORSEPOWER

APPAREL/  
SIGNAGE

K&N® PRODUCT LISTINGS



# PRODUCT LISTINGS

<b>AMERICAN V-TWIN PRODUCT LISTINGS .....</b>	<b>71</b>
<b>MOTORCYCLE PRODUCT LISTINGS .....</b>	<b>85</b>
<b>ATV / UTV / SIDE BY SIDE PRODUCT LISTINGS .....</b>	<b>139</b>
<b>HOW TO FIND THE UNIVERSAL FILTER FOR YOUR BIKE .....</b>	<b>151</b>
<b>SPECIALTY FILTER PRODUCT LISTINGS .....</b>	<b>152</b>
<b>AIR FILTER WRAP PRODUCT LISTINGS .....</b>	<b>170</b>
<b>WARRANTY INFORMATION .....</b>	<b>174</b>
<b>AIR FILTER CLEANING INFORMATION .....</b>	<b>176</b>



# American V-Twin - Air & Oil Filters

Vehicle	Engine	Air Filter	Oil Filter	Vehicle	Engine	Air Filter	Oil Filter
<b>2010 BUELL</b>				<b>2004 BUELL</b>			
1125CR	1125	BU-1108	KN-564	Blast	480	BU-5000	KN-177
1125R	1125	BU-1108	KN-564	Firebolt XB9R	961	BU-9003	KN-177
Blast	500	BU-5000		Firebolt XB12R	1168	BU-9003	KN-177
Firebolt XB12R	1168	BU-9003	KN-177	Lightning XB9S	900	BU-9003	KN-177
Lightning City XB12SX	1200		KN-177	Lightning XB12S	1200	BU-9003	KN-177
Lightning CityX XB9SX	900	BU-9003	KN-177	<b>2003 BUELL</b>			
Lightning Long XB12SS	1200	BU-9003	KN-177	Blast	480	BU-5000	KN-177
Lightning XB12SCG	1200	BU-9003	KN-177	Firebolt XB9R	961	BU-9003	KN-177
Ulysses Police XB12XP	1200	BU-9003	KN-177	Lightning XB9S	900	BU-9003	KN-177
Ulysses XB12X	1200	BU-9003	KN-177	<b>2002 BUELL</b>			
Ulysses XB12XT	1200	BU-9003	KN-177	Blast	480	BU-5000	KN-177
<b>2009 BUELL</b>				Firebolt XB9R	1131	BU-9003	KN-177
1125CR	1125	BU-1108	KN-564	M2 Cyclone	1168	BU-1297	KN-171C*
1125R	1125	BU-1108	KN-564			BU-1297	SS-171
Blast	500	BU-5000	KN-177	M2 Cyclone Low	1168	BU-1297	KN-171C*
Firebolt XB12R	1168	BU-9003	KN-177			BU-1297	SS-171
Lightning CityX XB9SX	900	BU-9003	KN-177	S1 Lightning	1200	BU-1297	KN-177
Lightning Long XB12SS	1200	BU-9003	KN-177	S2 Thunderbolt	1200	BU-1297	KN-177
Lightning XB12SCG	1200	BU-9003	KN-177	S2T Thunderbolt	1200	BU-1297	KN-177
Ulysses Police XB12XP	1200	BU-9003	KN-177	S3 Thunderbolt	1168	BU-1297	KN-177
Ulysses XB12X	1168	BU-9003	KN-177	S3T Thunderbolt	1168	BU-1297	KN-177
Ulysses XB12XT	1168	BU-9003	KN-177	X1 Lightning	1200	BU-1297	KN-171C*
<b>2008 BUELL</b>						BU-1297	SS-171
1125R	1125	BU-1108		X1W White Lightning	1200	BU-1297	KN-171C*
Blast	480	BU-5000	KN-177			BU-1297	SS-171
Firebolt XB12R	1168	BU-9003	KN-177	<b>2001 BUELL</b>			
Lightning CityX XB9SX	900		KN-177	Blast	480	BU-5000	KN-177
Lightning Long XB12SS	1200	BU-9003	KN-177	M2 Cyclone	1168	BU-1297	KN-171C*
Lightning XB9SX	900	BU-9003	KN-177			BU-1297	SS-171
Lightning XB12S	1200	BU-9003	KN-177	S1 Lightning	1200	BU-1297	KN-177
Lightning XB12SCG	1200	BU-9003	KN-177	S2 Thunderbolt	1200	BU-1297	KN-177
Lightning XB12STT	1200	BU-9003	KN-177	S2T Thunderbolt	1200	BU-1297	KN-177
Ulysses XB12X	1168	BU-9003	KN-177	S3 Thunderbolt	1168	BU-1297	KN-177
Ulysses XB12XT	1168	BU-9003	KN-177	S3T Thunderbolt	1168	BU-1297	KN-177
<b>2007 BUELL</b>				X1 Lightning	1200	BU-1297	KN-171C*
Blast	480	BU-5000	KN-177			BU-1297	SS-171
Firebolt XB9R	961	BU-9003	KN-177	<b>2000 BUELL</b>			
Firebolt XB12R	1168	BU-9003	KN-177	Blast	480	BU-5000	KN-177
Lightning CityX XB9SX	900	BU-9003	KN-177	M2 Cyclone	1168	BU-1297	KN-171C*
Lightning Long XB12SS	1200	BU-9003	KN-177			BU-1297	SS-171
Lightning XB12S	1200	BU-9003	KN-177	S1 Lightning	1200	BU-1297	KN-177
Lightning XB12SCG	1200	BU-9003	KN-177	S2 Thunderbolt	1200	BU-1297	KN-177
Lightning XB12STT	1200	BU-9003	KN-177	S2T Thunderbolt	1200	BU-1297	KN-177
Ulysses XB12X	1168	BU-9003	KN-177	S3 Thunderbolt	1168	BU-1297	KN-177
<b>2006 BUELL</b>				S3T Thunderbolt	1168	BU-1297	KN-177
Blast	480	BU-5000	KN-177	X1 Lightning	1200	BU-1297	KN-171C*
Firebolt XB9R	961	BU-9003	KN-177			BU-1297	SS-171
Firebolt XB12R	1168	BU-9003	KN-177	<b>2016 HARLEY DAVIDSON</b>			
Lightning CityX XB9SX	900	BU-9003	KN-177	FLD Dyna Switchback	103 CI	HD-0910	KN-171C*
Lightning Long XB12SS	1200	BU-9003	KN-177			HD-0910	SS-171
Lightning XB12S	1200	BU-9003	KN-177	FLD Dyna Switchback - Non-US	103 CI	HD-9608	
Lightning XB12SCG	1200	BU-9003	KN-177	FLHR Road King	103 CI	HD-1614	◆ KN-171C*
Ulysses XB12X	1168	BU-9003	KN-177			HD-1614	◆ SS-171
<b>2005 BUELL</b>				FLHSSE CVO Street Glide	110 CI		KN-171C*
Blast	480	BU-5000	KN-177				SS-171
Firebolt XB9R	961	BU-9003	KN-177	FLHTCU Electra Glide Ultra Classic	103 CI	HD-1614	KN-171C*
Firebolt XB12R	1168	BU-9003	KN-177			HD-1614	SS-171
Lightning CityX XB9SX	900	BU-9003	KN-177	FLHTCUL Electra Glide Ultra Classic	103 CI		KN-171C*
Lightning XB12S	1200	BU-9003	KN-177	Low			SS-171
Lightning XB12SCG	1200	BU-9003	KN-177	FLHTCUTG Tri Glide Ultra	103 CI	HD-1614	KN-171C*

◆ Intake Available - See Pages 10-13    ^ Use KN-170 for Black    \* Change C to B for Black    Applications updated daily at [knfilters.com](http://knfilters.com) ®

# American V-Twin - Air & Oil Filters

Vehicle	Engine	Air Filter	Oil Filter	Vehicle	Engine	Air Filter	Oil Filter
<b>2016 HARLEY DAVIDSON</b>				<b>2016 HARLEY DAVIDSON</b>			
FLHTCUTG Tri Glide Ultra	103 CI	HD-1614	SS-171	XL1200V Seventy-Two	74 CI	HD-1212 ♦	KN-171C*
FLHTK Ultra Limited	103 CI	HD-1614	KN-171C*			HD-1212 ♦	SS-171
		HD-1614	SS-171	XL1200X Forty-Eight	74 CI		KN-171C*
FLHTKL Ultra Limited Low	103 CI	HD-1614	KN-171C*				SS-171
		HD-1614	SS-171	<b>2015 HARLEY DAVIDSON</b>			
FLHTKSE CVO Limited	110 CI		KN-171C*	FLD Dyna Switchback	103 CI	HD-9608 ♦	KN-171C*
			SS-171			HD-9608 ♦	SS-171
FLHX Electra Glide Special	103 CI	HD-1614		FLHR Road King	103 CI	HD-1614 ♦	KN-171C*
FLHX Street Glide	103 CI	HD-1614	KN-171C*			HD-1614 ♦	SS-171
		HD-1614	SS-171	FLHTCU Electra Glide Ultra Classic	103 CI	HD-1614 ♦	KN-171C*
FLHXS Street Glide Special	103 CI		KN-171C*			HD-1614 ♦	SS-171
			SS-171	FLHTCUL Electra Glide Ultra Classic Low	103 CI	HD-1614 ♦	KN-171C*
FLHXSE CVO Street Glide	110 CI	HD-0910				HD-1614 ♦	SS-171
FLRT Freewheeler	103 CI	HD-1614 ♦	KN-171C*				
		HD-1614 ♦	SS-171	FLHTCUTG Tri Glide Ultra	103 CI	HD-1614 ♦	KN-171C*
FLS Softail Slim	103 CI	HD-1614 ♦	KN-171C*			HD-1614 ♦	SS-171
		HD-1614 ♦	SS-171	FLHTK Ultra Limited	103 CI	HD-1614 ♦	KN-171C*
FLSS Softail Slim S	110 CI		KN-171C*			HD-1614 ♦	SS-171
			SS-171	FLHTKL Ultra Limited Low	103 CI	HD-1614 ♦	KN-171C*
FLSTC Heritage Softail Classic	103 CI	HD-1614 ♦	KN-171C*			HD-1614 ♦	SS-171
		HD-1614 ♦	SS-171	FLHTKSE CVO Limited	110 CI	HD-0910	KN-171C*
FLSTF Fat Boy	103 CI	HD-1614 ♦	KN-171C*			HD-0910	SS-171
		HD-1614 ♦	SS-171	FLHX Street Glide	103 CI	HD-1614 ♦	KN-171C*
FLSTFB Softail Fat Boy Lo	103 CI	HD-1614 ♦	KN-171C*			HD-1614 ♦	SS-171
		HD-1614 ♦	SS-171	FLHXS Street Glide Special	103 CI	HD-1614 ♦	KN-171C*
FLSTFBS Fat Boy S	110 CI		KN-171C*			HD-1614 ♦	SS-171
			SS-171	FLHXSE CVO Street Glide	110 CI	HD-0910	KN-171C*
FLSTN Softail Deluxe	103 CI	HD-1614 ♦	KN-171C*			HD-0910	SS-171
		HD-1614 ♦	SS-171	FLRT Freewheeler	103 CI	HD-1614 ♦	KN-171C*
FLTRU Road Glide Ultra	103 CI	HD-1614	KN-171C*			HD-1614 ♦	SS-171
		HD-1614	SS-171	FLS Softail Slim	103 CI	HD-1611 ♦	KN-171C*
FLTRUSE CVO Road Glide Ultra	110 CI	HD-0910	KN-171C*			HD-1611 ♦	SS-171
		HD-0910	SS-171	FLSTC Heritage Softail Classic	103 CI	HD-1499 ♦	KN-171C*
FLTRX Road Glide	103 CI	HD-1614 ♦	KN-171C*			HD-1499 ♦	SS-171
		HD-1614 ♦	SS-171	FLSTF Fat Boy	103 CI	HD-1499 ♦	KN-171C*
FLTRXS Road Glide Special	103 CI	HD-1614 ♦	KN-171C*			HD-1499 ♦	SS-171
		HD-1614 ♦	SS-171	FLSTFB Softail Fat Boy Lo	103 CI	HD-1499 ♦	KN-171C*
FXDB Dyna Street Bob	103 CI	HD-1611	KN-171C*			HD-1499 ♦	SS-171
		HD-1611	SS-171	FLSTN Softail Deluxe	103 CI	HD-1499 ♦	KN-171C*
FXDF Fat Bob	103 CI	HD-0910	KN-171C*			HD-1499 ♦	SS-171
		HD-0910	SS-171	FLSTNSE CVO Softail Deluxe	110 CI	HD-0910	KN-171C*
FXDF Fat Bob - Non-US	103 CI	HD-9608				HD-0910	SS-171
FXDL Dyna Low Rider	103 CI	HD-0910	KN-171C*	FLTRUSE CVO Road Glide Ultra	110 CI	HD-0910	KN-171C*
		HD-0910	SS-171			HD-0910	SS-171
FXDL Dyna Low Rider - Non-US	103 CI	HD-9608		FLTRX Road Glide	103 CI	HD-1614 ♦	KN-171C*
FXDWG Dyna Wide Glide	103 CI	HD-0910	KN-171C*			HD-1614 ♦	SS-171
		HD-0910	SS-171	FLTRXS Road Glide Special	103 CI	HD-1614 ♦	KN-171C*
FXDWG Dyna Wide Glide - Non-US	103 CI	HD-9608				HD-1614 ♦	SS-171
FXSB Breakout	103 CI	HD-1614 ♦	KN-171C*	FXDB Dyna Street Bob	103 CI	HD-1611 ♦	KN-171C*
		HD-1614 ♦	SS-171			HD-1611 ♦	SS-171
VRSCDX Night Rod Special	76 CI	HD-1102		FXDF Fat Bob	103 CI		KN-171C*
VRSCF V-Rod Muscle	76 CI	HD-1102					SS-171
XG500 Street	30 CI	HD-4915 ♦	KN-204	FXDL Dyna Low Rider	103 CI	HD-9608 ♦	KN-171C*
		HD-4915 ♦	KN-204C			HD-9608 ♦	SS-171
XG750 Street	46 CI	HD-4915 ♦	KN-204	FXDWG Dyna Wide Glide	103 CI	HD-9608 ♦	KN-171C*
		HD-4915 ♦	KN-204C			HD-9608 ♦	SS-171
XL883L SuperLow	54 CI	HD-1212 ♦	KN-171C*	FXSB Breakout	103 CI	HD-1499 ♦	KN-171C*
		HD-1212 ♦	SS-171			HD-1499 ♦	SS-171
XL883N Iron	54 CI	HD-1212 ♦	KN-171C*	VRSCDX Night Rod Special	76 CI	HD-1102	KN-174C*
		HD-1212 ♦	SS-171	VRSCF V-Rod Muscle	76 CI	HD-1102	KN-174C*
XL1200C Sportster Custom	74 CI	HD-1212 ♦	KN-171C*	XG500 Street	30 CI	HD-4915 ♦	KN-204
		HD-1212 ♦	SS-171			HD-4915 ♦	KN-204C
XL1200T SuperLow	74 CI	HD-1212 ♦	KN-171C*	XG750 Street	46 CI	HD-4915 ♦	KN-204
		HD-1212 ♦	SS-171				

♦ Intake Available - See Pages 10-13    ^ Use KN-170 for Black    \* Change C to B for Black    Applications updated daily at [knfilters.com](http://knfilters.com) ®

# American V-Twin - Air & Oil Filters

Vehicle	Engine	Air Filter	Oil Filter	Vehicle	Engine	Air Filter	Oil Filter
<b>2015 HARLEY DAVIDSON</b>				<b>2014 HARLEY DAVIDSON</b>			
XG750 Street	46 CI	HD-4915	KN-204C	XL883L SuperLow	54 CI	HD-1212	KN-170C^
XL883L SuperLow	54 CI	HD-1212	KN-171C*			HD-1212	SS-171
		HD-1212	SS-171	XL883N Iron	54 CI	HD-1212	KN-170C^
XL883N Iron	54 CI	HD-1212	KN-171C*			HD-1212	SS-171
		HD-1212	SS-171	XL1200C Sportster Custom	74 CI	HD-1212	KN-170C^
XL1200C Sportster Custom	74 CI	HD-1212	KN-171C*			HD-1212	SS-171
		HD-1212	SS-171	XL1200T SuperLow	74 CI	HD-1212	
XL1200T SuperLow	74 CI	HD-1212	KN-171C*	XL1200V Seventy-Two	74 CI	HD-1212	KN-170C^
		HD-1212	SS-171			HD-1212	SS-171
XL1200V Seventy-Two	74 CI	HD-1212	KN-171C*	XL1200X Forty-Eight	74 CI	HD-1212	KN-170C^
		HD-1212	SS-171			HD-1212	SS-171
XL1200X Forty-Eight	74 CI	HD-1212	KN-171C*			HD-1212	SS-171
		HD-1212	SS-171	<b>2013 HARLEY DAVIDSON</b>			
<b>2014 HARLEY DAVIDSON</b>				FLD Dyna Switchback	103 CI	HD-9608	KN-171C*
FLD Dyna Switchback	103 CI	HD-9608	KN-171C*			HD-9608	SS-171
		HD-9608	SS-171	FLHR Road King	103 CI	HD-1508	KN-171C*
FLHR Road King	103 CI	HD-1614	KN-171C*			HD-1508	SS-171
		HD-1614	SS-171	FLHRC Road King Classic	103 CI	HD-1508	KN-171C*
FLHRSE6 CVO Road King	110 CI		KN-171C*			HD-1508	SS-171
			SS-171	FLHRSE5 CVO Road King	110 CI	HD-0910	KN-171C*
FLHTCU Electra Glide Ultra Classic	103 CI	HD-1614	KN-171C*			HD-0910	SS-171
		HD-1614	SS-171	FLHTC Electra Glide Classic	103 CI	HD-1508	KN-171C*
FLHTCUTG Tri Glide Ultra	103 CI	HD-1614	KN-171C*			HD-1508	SS-171
		HD-1614	SS-171	FLHTCU Ultra Classic Electra Glide	103 CI	HD-1508	KN-171C*
FLHTK Electra Glide Ultra Limited	103 CI	HD-1614	KN-171C*			HD-1508	SS-171
		HD-1614	SS-171	FLHTCUSE8 CVO Ultra Classic Electra Glide F/I	110 CI	HD-0910	KN-171C*
FLHTKSE CVO Limited	110 CI	HD-0910	KN-171C*			HD-0910	SS-171
		HD-0910	SS-171	FLHTCUTG Tri Glide Ultra Classic	103 CI	HD-1508	KN-171C*
FLHX Street Glide	103 CI	HD-1614	KN-171C*			HD-1508	SS-171
		HD-1614	SS-171	FLHTK Electra Glide Ultra Limited	103 CI	HD-1508	KN-171C*
FLHXS Street Glide Special	103 CI	HD-1614	KN-171C*			HD-1508	SS-171
		HD-1614	SS-171	FLHX Street Glide	103 CI	HD-1508	KN-171C*
FLS Softail Slim	103 CI	HD-1611	KN-171C*			HD-1508	SS-171
		HD-1611	SS-171	FLS Softail Slim	103 CI	HD-1611	KN-171C*
FLSTC Heritage Softail Classic	103 CI	HD-1499	KN-171C*			HD-1611	SS-171
		HD-1499	SS-171	FLSTC Heritage Softail Classic	103 CI	HD-1499	KN-171C*
FLSTF Fat Boy	103 CI	HD-1499	KN-171C*			HD-1499	SS-171
		HD-1499	SS-171	FLSTF Fat Boy	103 CI	HD-1499	KN-171C*
FLSTFB Softail Fat Boy Lo	103 CI	HD-1499	KN-171C*			HD-1499	SS-171
		HD-1499	SS-171	FLSTFB Softail Fat Boy Lo	103 CI	HD-1499	KN-171C*
FLSTN Softail Deluxe	103 CI	HD-1499	KN-171C*			HD-1499	SS-171
		HD-1499	SS-171	FLSTN Softail Deluxe	103 CI	HD-1499	KN-171C*
FLSTNSE CVO Softail Deluxe	110 CI	HD-0910	KN-171C*			HD-1499	SS-171
		HD-0910	SS-171	FLTRU Road Glide Ultra	103 CI	HD-1508	KN-171C*
FXDB Dyna Street Bob	103 CI	HD-1611	KN-171C*			HD-1508	SS-171
		HD-1611	SS-171	FLTRX Road Glide Custom	103 CI	HD-1508	KN-171C*
FXDC Dyna Super Glide Custom	103 CI	HD-9608	KN-171C*			HD-1508	SS-171
		HD-9608	SS-171	FLTRXSE CVO Road Glide Custom	96 CI		KN-171C*
FXDF Fat Bob	103 CI	HD-9608	KN-171C*				SS-171
		HD-9608	SS-171	FXDB Dyna Street Bob	96 CI	HD-9608	KN-171C*
FXDL Dyna Low Rider	103 CI	HD-9608	KN-171C*			HD-9608	SS-171
		HD-9608	SS-171	FXDC Dyna Super Glide Custom	96 CI	HD-9608	KN-171C*
FXDWG Dyna Wide Glide	103 CI	HD-9608	KN-171C*			HD-9608	SS-171
		HD-9608	SS-171	FXDC Super Glide Custom	96 CI	HD-9608	KN-171C*
FXSB Breakout	103 CI	HD-1499	KN-171C*			HD-9608	SS-171
		HD-1499	SS-171	FXDF Fat Bob	103 CI	HD-9608	KN-171C*
FXSBSE CVO Breakout	103 CI		KN-171C*			HD-9608	SS-171
			SS-171	FXDWG Dyna Wide Glide	103 CI	HD-9608	KN-171C*
VRSCDX Night Rod Special	76 CI	HD-1102				HD-9608	SS-171
VRSCF V-Rod Muscle	76 CI	HD-1102		FXS Blackline	103 CI	HD-1611	KN-171C*
XG500 Street	30 CI		KN-204			HD-1611	SS-171
			KN-204C	FXSBSE CVO Breakout	110 CI		KN-171C*
XG750 Street	46 CI		KN-204				SS-171
			KN-204C				

◆ Intake Available - See Pages 10-13    ^ Use KN-170 for Black    \* Change C to B for Black    Applications updated daily at [knfilters.com](http://knfilters.com) ®

**Partial Listing - Complete List of Vehicles and Applications at [knfilters.com](http://knfilters.com)**

# American V-Twin - Air & Oil Filters

Vehicle	Engine	Air Filter	Oil Filter	Vehicle	Engine	Air Filter	Oil Filter
<b>2013 HARLEY DAVIDSON</b>				<b>2012 HARLEY DAVIDSON</b>			
VRSCDX Night Rod Special	76 CI	HD-1102		FXS Blackline	103 CI	HD-1611 ♦	SS-171
VRSCF V-Rod Muscle	76 CI	HD-1102		VRSCDX 10th Anniversary Edition	76 CI	HD-1102	
XL883L SuperLow	54 CI	HD-8834 ♦	KN-170C^	VRSCDX Night Rod Special	76 CI	HD-1102	
		HD-8834 ♦	SS-171	VRSCF V-Rod Muscle	76 CI	HD-1102	
XL883N Iron	54 CI	HD-8834 ♦	KN-170C^	XL883L SuperLow	54 CI	HD-8834 ♦	KN-170C^
		HD-8834 ♦	SS-171			HD-8834 ♦	SS-171
XL1200C Sportster Custom	74 CI	HD-8834 ♦	KN-170C^	XL883N Iron	54 CI	HD-8834 ♦	KN-170C^
		HD-8834 ♦	SS-171			HD-8834 ♦	SS-171
XL1200V Seventy-Two	74 CI	HD-1212 ♦	KN-170C^	XL883R Sportster Roadster	54 CI	HD-8834	KN-170C^
		HD-1212 ♦	SS-171			HD-8834	SS-171
XL1200X Forty-Eight	74 CI	HD-8834 ♦	KN-170C^	XL1200C Sportster Custom	74 CI	HD-8834 ♦	KN-170C^
		HD-8834 ♦	SS-171			HD-8834 ♦	SS-171
<b>2012 HARLEY DAVIDSON</b>				XL1200N Sportster Nightster	74 CI	HD-8834 ♦	KN-170C^
FLD Dyna Switchback	103 CI	HD-9608	KN-171C*			HD-8834 ♦	SS-171
		HD-9608	SS-171	XL1200V Seventy-Two	74 CI	HD-1212 ♦	
FLHP Road King Police	103 CI	HD-1508 ♦		XL1200X Forty-Eight	74 CI	HD-8834 ♦	KN-170C^
FLHR Road King	103 CI	HD-1508 ♦	KN-171C*			HD-8834 ♦	SS-171
		HD-1508 ♦	SS-171	XR1200X Sportster	74 CI	HD-1208	KN-170C^
FLHRC Road King Classic	103 CI	HD-1508 ♦	KN-171C*			HD-1208	SS-171
		HD-1508 ♦	SS-171	<b>2011 HARLEY DAVIDSON</b>			
FLHTC Electra Glide Classic	103 CI	HD-1508 ♦	KN-171C*	FLHP Road King Police	103 CI	HD-1508 ♦	
		HD-1508 ♦	SS-171	FLHR Road King	96 CI	HD-1508 ♦	KN-171C*
FLHTCU Electra Glide Ultra Classic	103 CI	HD-1508 ♦	KN-171C*			HD-1508 ♦	SS-171
		HD-1508 ♦	SS-171	FLHRC Road King Classic	103 CI	HD-1508 ♦	KN-171C*
FLHTCUSE7 CVO Ultra Classic	110 CI	HD-0910	KN-171C*			HD-1508 ♦	SS-171
Electra Glide		HD-0910	SS-171	FLHTC Electra Glide Classic	96 CI	HD-1508 ♦	KN-171C*
						HD-1508 ♦	SS-171
FLHTCUTG Tri Glide Ultra Classic	103 CI	HD-1508 ♦	KN-171C*	FLHTCU Ultra Classic Electra Glide	96 CI	HD-1508 ♦	KN-171C*
		HD-1508 ♦	SS-171			HD-1508 ♦	SS-171
FLHTK Electra Glide Ultra Limited	103 CI	HD-1508 ♦	KN-171C*	FLHTCUSE6 CVO Ultra Classic	110 CI	HD-0910	KN-171C*
		HD-1508 ♦	SS-171	Electra Glide		HD-0910	SS-171
FLHTP Electra Glide Police	103 CI	HD-1508					
FLHX Street Glide	103 CI	HD-1508 ♦	KN-171C*	FLHTCUTG Tri Glide Ultra Classic	103 CI	HD-1508 ♦	KN-171C*
		HD-1508 ♦	SS-171			HD-1508 ♦	SS-171
FLHXSE3 CVO Street Glide	110 CI	HD-0910	KN-171C*	FLHTK Electra Glide Ultra Limited	103 CI	HD-1508 ♦	KN-171C*
		HD-0910	SS-171			HD-1508 ♦	SS-171
FLS Softail Slim	103 CI	HD-1611	KN-171C*	FLHTP Electra Glide Police	103 CI	HD-1508 ♦	
		HD-1611	SS-171	FLHX Street Glide	96 CI	HD-1508 ♦	KN-171C*
FLSTC Heritage Softail Classic	103 CI	HD-1499 ♦	KN-171C*			HD-1508 ♦	SS-171
		HD-1499 ♦	SS-171	FLHXSE2 CVO Street Glide	110 CI	HD-0910	KN-171C*
FLSTF Fat Boy	103 CI	HD-1499 ♦	KN-171C*			HD-0910	SS-171
		HD-1499 ♦	SS-171	FLHXXX Street Glide Trike	103 CI	HD-1508 ♦	KN-171C*
FLSTFB Softail Fat Boy Lo	103 CI	HD-1499 ♦	KN-171C*			HD-1508 ♦	SS-171
		HD-1499 ♦	SS-171	FLSTC Heritage Softail Classic	96 CI	HD-1499 ♦	KN-171C*
FLSTN Softail Deluxe	103 CI	HD-1499 ♦	KN-171C*			HD-1499 ♦	SS-171
		HD-1499 ♦	SS-171	FLSTF Fat Boy	96 CI	HD-1499 ♦	KN-171C*
FLSTSE CVO Softail Convertible	110 CI	HD-0910	KN-171C*			HD-1499 ♦	SS-171
		HD-0910	SS-171	FLSTFB Softail Fat Boy Lo	96 CI	HD-1499 ♦	KN-171C*
FLTRU Road Glide Ultra	103 CI	HD-1508 ♦	KN-171C*			HD-1499 ♦	SS-171
		HD-1508 ♦	SS-171	FLSTN Softail Deluxe	96 CI	HD-1499 ♦	KN-171C*
FLTRX Road Glide Custom	103 CI	HD-1508 ♦	KN-171C*			HD-1499 ♦	SS-171
		HD-1508 ♦	SS-171	FLSTSB Softail Cross Bones	96 CI	HD-1611 ♦	KN-171C*
FLTRXSE CVO Road Glide Custom	96 CI		KN-171C*			HD-1611 ♦	SS-171
			SS-171	FLSTSE CVO Softail Convertible	110 CI	HD-0910	KN-171C*
FXDB Dyna Street Bob	96 CI	HD-9608 ♦	KN-171C*			HD-0910	SS-171
		HD-9608 ♦	SS-171	FLTRU Road Glide Ultra	103 CI	HD-1508 ♦	KN-171C*
FXDC Dyna Super Glide Custom	96 CI	HD-9608 ♦	KN-171C*			HD-1508 ♦	SS-171
		HD-9608 ♦	SS-171	FLTRUSE CVO Road Glide Ultra	110 CI	HD-0910	KN-171C*
FXDF Fat Bob	103 CI	HD-9608 ♦	KN-171C*			HD-0910	SS-171
		HD-9608 ♦	SS-171	FLTRX Road Glide Custom	96 CI	HD-1508 ♦	KN-171C*
FXDWG Dyna Wide Glide	103 CI	HD-9608 ♦	KN-171C*			HD-1508 ♦	SS-171
		HD-9608 ♦	SS-171	FXCWC Rocker C	96 CI	HD-1499 ♦	KN-171C*
FXS Blackline	103 CI	HD-1611 ♦	KN-171C*			HD-1499 ♦	SS-171

♦ Intake Available - See Pages 10-13    ^ Use KN-170 for Black    \* Change C to B for Black    Applications updated daily at [knfilters.com](http://knfilters.com) ®

# American V-Twin - Air & Oil Filters

Vehicle	Engine	Air Filter	Oil Filter	Vehicle	Engine	Air Filter	Oil Filter
<b>2011 HARLEY DAVIDSON</b>				<b>2010 HARLEY DAVIDSON</b>			
FXDB Dyna Street Bob	96 CI	HD-9608	◆ KN-171C*	FLTR Road Glide	96 CI	HD-1508	◆ KN-171C*
		HD-9608	◆ SS-171			HD-1508	◆ SS-171
FXDC Dyna Super Glide Custom	96 CI	HD-9608	◆ KN-171C*	FLTRX Road Glide Custom	96 CI	HD-1508	◆ KN-171C*
		HD-9608	◆ SS-171			HD-1508	◆ SS-171
FXDF Fat Bob	96 CI	HD-9608	◆ KN-171C*	FXCWC Rocker C	96 CI	HD-1499	◆ KN-171C*
		HD-9608	◆ SS-171			HD-1499	◆ SS-171
FXDWG Dyna Wide Glide	96 CI	HD-9608	◆ KN-171C*	FXD Dyna Super Glide	96 CI	HD-9608	◆
		HD-9608	◆ SS-171	FXDB Dyna Street Bob	96 CI	HD-9608	◆ KN-171C*
FXS Blackline	103 CI	HD-1611	◆ KN-171C*			HD-9608	◆ SS-171
		HD-1611	◆ SS-171	FXDC Dyna Super Glide Custom	96 CI	HD-9608	◆ KN-171C*
VRSCDX Night Rod Special	76 CI	HD-1102				HD-9608	◆ SS-171
VRSCF V-Rod Muscle	76 CI	HD-1102		FXDF Fat Bob	96 CI	HD-9608	◆ KN-171C*
XL883L SuperLow	54 CI	HD-8834	◆ KN-170C^			HD-9608	◆ SS-171
		HD-8834	◆ SS-171	FXDFSE2 CVO Dyna Fat Bob	96 CI		KN-171C*
XL883N Iron	54 CI	HD-8834	◆ KN-170C^				SS-171
		HD-8834	◆ SS-171	FXDL Dyna Low Rider - Japan	96 CI	HD-9608	
XL1200C Sportster Custom	74 CI	HD-8834	◆ KN-170C^	FXDWG Dyna Wide Glide	96 CI	HD-9608	◆ KN-171C*
		HD-8834	◆ SS-171			HD-9608	◆ SS-171
XL1200L Sportster Low	74 CI	HD-8834	◆ KN-170C^	FXSTC Softail Custom	96 CI	HD-1499	◆ KN-171C*
		HD-8834	◆ SS-171			HD-1499	◆ SS-171
XL1200N Sportster Nightster	74 CI	HD-8834	◆ KN-170C^	VRSCAW V-Rod	69 CI	HD-1102	
		HD-8834	◆ SS-171	VRSCDX Night Rod Special	76 CI	HD-1102	KN-174C*
XL1200X Forty-Eight	74 CI	HD-8834	◆ KN-170C^	VRSCF V-Rod Muscle	76 CI	HD-1102	KN-174C*
		HD-8834	◆ SS-171	XL883C Sportster Custom	54 CI	HD-8834	◆ KN-170C^
XR1200X Sportster	74 CI	HD-1208	KN-170C^			HD-8834	◆ SS-171
		HD-1208	SS-171	XL883L Sportster Low	54 CI	HD-8834	◆ KN-170C^
						HD-8834	◆ SS-171
				XL883N Iron	54 CI	HD-8834	◆ KN-170C^
						HD-8834	◆ SS-171
				XL1200C Sportster Custom	74 CI	HD-8834	◆ KN-170C^
						HD-8834	◆ SS-171
				XL1200L Sportster Low	74 CI	HD-8834	◆ KN-170C^
						HD-8834	◆ SS-171
				XL1200N Sportster Nightster	74 CI	HD-8834	◆ KN-170C^
						HD-8834	◆ SS-171
				XL1200X Forty-Eight	74 CI	HD-8834	◆ KN-170C^
						HD-8834	◆ SS-171
				XR1200X Sportster	74 CI	HD-1208	KN-170C^
						HD-1208	SS-171
<b>2010 HARLEY DAVIDSON</b>				<b>2009 HARLEY DAVIDSON</b>			
FLHP Road King Police	103 CI	HD-1508	◆	FLHP Road King Police	103 CI	HD-1508	◆ KN-171C*
FLHR Road King	96 CI	HD-1508	◆ KN-171C*			HD-1508	◆ SS-171
		HD-1508	◆ SS-171	FLHR Road King	96 CI	HD-1508	◆ KN-171C*
FLHRC Road King Classic	96 CI	HD-1508	◆ KN-171C*			HD-1508	◆ SS-171
		HD-1508	◆ SS-171	FLHRC Road King Classic	96 CI	HD-1508	◆ KN-171C*
FLHT Electra Glide Standard	96 CI	HD-1508	◆			HD-1508	◆ SS-171
FLHTC Electra Glide Classic	96 CI	HD-1508	◆ KN-171C*	FLHT Electra Glide Standard	96 CI	HD-1508	◆ KN-171C*
		HD-1508	◆ SS-171			HD-1508	◆ SS-171
FLHTCU Ultra Classic Electra Glide	96 CI	HD-1508	◆ KN-171C*	FLHTC Electra Glide Classic	96 CI	HD-1508	◆ KN-171C*
		HD-1508	◆ SS-171			HD-1508	◆ SS-171
FLHTCUSE5 CVO Ultra Classic Electra Glide	110 CI	HD-1508	KN-171C*	FLHTCU Ultra Classic Electra Glide	96 CI	HD-1508	◆ KN-171C*
		HD-1508	SS-171			HD-1508	◆ SS-171
				FLHTCUSE4 CVO Ultra Classic Electra Glide	110 CI	HD-1508	KN-171C*
FLHTCUTG Tri Glide Ultra Classic	103 CI	HD-1508	◆ KN-171C*			HD-1508	SS-171
		HD-1508	◆ SS-171	FLHTCUTG Tri Glide Ultra Classic	103 CI	HD-1508	◆ KN-171C*
FLHTK Electra Glide Ultra Limited	103 CI	HD-1508	◆ KN-171C*			HD-1508	◆ SS-171
		HD-1508	◆ SS-171	FLHTP Electra Glide Police	103 CI	HD-1508	◆ KN-171C*
FLHTP Electra Glide Police	103 CI	HD-1508	◆			HD-1508	◆ SS-171
FLHX Street Glide	96 CI	HD-1508	◆ KN-171C*	FLHX Street Glide	96 CI	HD-1508	◆ KN-171C*
		HD-1508	◆ SS-171			HD-1508	◆ SS-171
FLHXSE CVO Street Glide	110 CI	HD-0910	KN-171C*	FLSTC Heritage Softail Classic	96 CI	HD-1499	◆ KN-171C*
		HD-0910	SS-171			HD-1499	◆ SS-171
FLHXXX Street Glide Trike	103 CI	HD-1508	◆ KN-171C*	FLSTF Fat Boy	96 CI	HD-1499	◆ KN-171C*
		HD-1508	◆ SS-171			HD-1499	◆ SS-171
FLSTC Heritage Softail Classic	96 CI	HD-1499	◆ KN-171C*	FLSTFB Softail Fat Boy Lo	96 CI	HD-1499	◆ KN-171C*
		HD-1499	◆ SS-171			HD-1499	◆ SS-171
FLSTF Fat Boy	96 CI	HD-1499	◆ KN-171C*	FLSTN Softail Deluxe	96 CI	HD-1499	◆ KN-171C*
		HD-1499	◆ SS-171			HD-1499	◆ SS-171
FLSTFB Softail Fat Boy Lo	96 CI	HD-1499	◆ KN-171C*	FLSTSB Softail Cross Bones	96 CI	HD-1611	◆ KN-171C*
		HD-1499	◆ SS-171			HD-1611	◆ SS-171
FLSTN Softail Deluxe	96 CI	HD-1499	◆ KN-171C*	FLSTSE CVO Softail Convertible	110 CI	HD-0910	KN-171C*
		HD-1499	◆ SS-171			HD-0910	SS-171
FLSTSB Softail Cross Bones	96 CI	HD-1611	◆ KN-171C*				
		HD-1611	◆ SS-171				
FLSTSE CVO Softail Convertible	110 CI	HD-0910	KN-171C*				
		HD-0910	SS-171				

◆ Intake Available - See Pages 10-13    ^ Use KN-170 for Black    \* Change C to B for Black    Applications updated daily at [knfilters.com](http://knfilters.com) ®

**Partial Listing - Complete List of Vehicles and Applications at [knfilters.com](http://knfilters.com)**

# American V-Twin - Air & Oil Filters

Vehicle	Engine	Air Filter	Oil Filter	Vehicle	Engine	Air Filter	Oil Filter
<b>2009 HARLEY DAVIDSON</b>				<b>2008 HARLEY DAVIDSON</b>			
FLSTF Fat Boy	96 CI	HD-1499 ♦	KN-171C*	FLHTC Electra Glide Classic	96 CI	HD-1508 ♦	KN-171C*
		HD-1499 ♦	SS-171			HD-1508 ♦	SS-171
FLSTN Softail Deluxe	96 CI	HD-1499 ♦	KN-171C*	FLHTCU Ultra Classic Electra Glide	96 CI	HD-1508 ♦	KN-171C*
		HD-1499 ♦	SS-171			HD-1508 ♦	SS-171
FLSTSB Softail Cross Bones	96 CI		KN-171C*	FLHTCUSE3 Screamin Eagle Ultra Classic Electra Gl	110 CI	HD-1508	KN-171C*
			SS-171			HD-1508	SS-171
FLSTSB Softail Cross Bones - Non-US	96 CI	HD-1499 ♦	KN-171C*	FLHX Street Glide	96 CI	HD-1508 ♦	KN-171C*
FLSTSB Softail Cross Bones - US	96 CI	HD-1611 ♦	KN-171C*			HD-1508 ♦	SS-171
FLTR Road Glide	96 CI	HD-1508 ♦	KN-171C*	FLSTC Heritage Softail Classic	96 CI	HD-1499 ♦	KN-171C*
		HD-1508 ♦	SS-171			HD-1499 ♦	SS-171
FLTRSE3 CVO Road Glide	110 CI	HD-0910	KN-171C*	FLSTF Fat Boy	96 CI	HD-1499 ♦	KN-171C*
		HD-0910	SS-171			HD-1499 ♦	SS-171
FXCW Rocker	96 CI	HD-1499 ♦	KN-171C*	FLSTN Softail Deluxe	96 CI	HD-1499 ♦	KN-171C*
		HD-1499 ♦	SS-171			HD-1499 ♦	SS-171
FXCWC Rocker C	96 CI	HD-1499 ♦	KN-171C*	FLSTSB Softail Cross Bones	96 CI		KN-171C*
		HD-1499 ♦	SS-171				SS-171
FXD Dyna Super Glide	96 CI	HD-9608 ♦	KN-171C*	FLSTSB Softail Cross Bones - Non-US	96 CI	HD-1499 ♦	KN-171C*
		HD-9608 ♦	SS-171	FLSTSB Softail Cross Bones - US	96 CI	HD-1611 ♦	KN-171C*
FXDB Dyna Street Bob	96 CI	HD-9608 ♦	KN-171C*	FLTR Road Glide	96 CI	HD-1508 ♦	KN-171C*
		HD-9608 ♦	SS-171			HD-1508 ♦	SS-171
FXDC Dyna Super Glide Custom	96 CI	HD-9608 ♦	KN-171C*	FXCW Rocker	96 CI	HD-1499 ♦	KN-171C*
		HD-9608 ♦	SS-171			HD-1499 ♦	SS-171
FXDF Fat Bob	96 CI	HD-9608 ♦	KN-171C*	FXCWC Rocker C	96 CI	HD-1499 ♦	KN-171C*
		HD-9608 ♦	SS-171			HD-1499 ♦	SS-171
FXDFSE CVO Fat Bob	110 CI		KN-171C*	FXD Dyna Super Glide	96 CI	HD-9608 ♦	KN-171C*
			SS-171			HD-9608 ♦	SS-171
FXDFSE CVO Fat Bob - Non-US	110 CI	HD-1499	KN-171C*	FXDB Dyna Street Bob	96 CI	HD-9608 ♦	KN-171C*
FXDL Dyna Low Rider	96 CI	HD-9608 ♦	KN-171C*			HD-9608 ♦	SS-171
		HD-9608 ♦	SS-171	FXDC Super Glide Custom	96 CI	HD-9608 ♦	KN-171C*
FXSTB Night Train	96 CI	HD-1499 ♦	KN-171C*			HD-9608 ♦	SS-171
		HD-1499 ♦	SS-171	FXDF Fat Bob	96 CI	HD-9608 ♦	KN-171C*
FXSTC Softail Custom	96 CI	HD-1499 ♦	KN-171C*			HD-9608 ♦	SS-171
		HD-1499 ♦	SS-171	FXDL Dyna Low Rider	96 CI	HD-9608 ♦	KN-171C*
FXSTSSE3 CVO Softail Springer	110 CI	HD-1499	KN-171C*			HD-9608 ♦	SS-171
		HD-1499	SS-171	FXDSE2 Screamin Eagle Dyna	110 CI		KN-171C*
VRSCAW V-Rod	69 CI	HD-1102	KN-174C*				SS-171
VRSCDX Night Rod Special	76 CI	HD-1102	KN-174C*	FXDSE2 Screamin Eagle Dyna - US	110 CI	HD-0800	KN-171C*
VRSCF V-Rod Muscle	76 CI	HD-1102	KN-174C*	FXDWG Dyna Wide Glide	96 CI	HD-9608 ♦	KN-171C*
XL883C Sportster Custom	54 CI	HD-8834 ♦	KN-170C^			HD-9608 ♦	SS-171
		HD-8834 ♦	SS-171	FXSTB Night Train	96 CI	HD-1499 ♦	KN-171C*
XL883L Sportster Low	54 CI	HD-8834 ♦	KN-170C^			HD-1499 ♦	SS-171
		HD-8834 ♦	SS-171	FXSTC Softail Custom	96 CI	HD-1499 ♦	KN-171C*
XL883N Iron	54 CI	HD-8834 ♦	KN-170C^			HD-1499 ♦	SS-171
		HD-8834 ♦	SS-171	FXSTSSE2 Screamin Eagle Softail Springer	110 CI		KN-171C*
XL1200C Sportster Custom	74 CI	HD-8834 ♦	KN-170C^				SS-171
		HD-8834 ♦	SS-171	VRSCAW V-Rod	69 CI	HD-1102	KN-174C*
XL1200L Sportster Low	74 CI	HD-8834 ♦	KN-170C^	VRSCD Night Rod	76 CI	HD-1102	KN-174C*
		HD-8834 ♦	SS-171	VRSCDX Night Rod Special	76 CI	HD-1102	KN-174C*
XL1200N Sportster Nightster	74 CI	HD-8834 ♦	KN-170C^	XL883 Sportster	54 CI	HD-8834 ♦	KN-170C^
		HD-8834 ♦	SS-171			HD-8834 ♦	SS-171
XR1200	74 CI	HD-1208	KN-170C^	XL883C Sportster Custom	54 CI	HD-8834 ♦	KN-170C^
		HD-1208	SS-171			HD-8834 ♦	SS-171
<b>2008 HARLEY DAVIDSON</b>				XL883L Sportster Low	54 CI	HD-8834 ♦	KN-170C^
FLHR Road King	96 CI	HD-1508 ♦	KN-171C*			HD-8834 ♦	SS-171
		HD-1508 ♦	SS-171	XL1200C Sportster Custom	74 CI	HD-8834 ♦	KN-170C^
FLHRC Road King Classic	96 CI	HD-1508 ♦	KN-171C*			HD-8834 ♦	SS-171
		HD-1508 ♦	SS-171	XL1200L Sportster Low	74 CI	HD-8834 ♦	KN-170C^
FLHRSE4 Screamin Eagle Road King	110 CI	HD-1508 ♦	KN-171C*			HD-8834 ♦	SS-171
		HD-1508 ♦	SS-171	XL1200N Sportster Nightster	74 CI	HD-8834 ♦	KN-170C^
FLHT Electra Glide Standard	96 CI	HD-1508 ♦	KN-171C*			HD-8834 ♦	SS-171
		HD-1508 ♦	SS-171				

♦ Intake Available - See Pages 10-13    ^ Use KN-170 for Black    \* Change C to B for Black    Applications updated daily at [knfilters.com](http://knfilters.com) ®

# American V-Twin - Air & Oil Filters

Vehicle	Engine	Air Filter	Oil Filter	Vehicle	Engine	Air Filter	Oil Filter
<b>2008 HARLEY DAVIDSON</b>				<b>2007 HARLEY DAVIDSON</b>			
XL1200R Sportster Roadster	74 CI	HD-8834 ♦	KN-170C^	FXSTD Softail Deuce	96 CI	HD-1499 ♦	KN-171C*
		HD-8834 ♦	SS-171			HD-1499 ♦	SS-171
XR1200	74 CI	HD-1208	KN-170C^	FXSTSSE Screamin Eagle Softail Springer	110 CI		KN-171C*
		HD-1208	SS-171				SS-171
<b>2007 HARLEY DAVIDSON</b>				<b>2007 HARLEY DAVIDSON</b>			
FLHR Road King	96 CI	HD-1499 ♦	KN-171C*	FXSTSSE Screamin Eagle Softail Springer - OEM 2944299A/B/C/D	110 CI	HD-0800	KN-171C*
		HD-1499 ♦	SS-171	VRSCAW V-Rod	69 CI	HD-1102	KN-174C*
FLHRC Road King Classic	96 CI	HD-1499 ♦	KN-171C*	VRSCD Night Rod	69 CI	HD-1102	KN-174C*
		HD-1499 ♦	SS-171	VRSCDX Night Rod Special	69 CI	HD-1102	KN-174C*
FLHRS Road King Custom	96 CI	HD-1499 ♦	KN-171C*	VRSCR Street Rod	69 CI	HD-1102	KN-174C*
		HD-1499 ♦	SS-171	VRSCX	69 CI		KN-174C*
FLHRSE3 Screamin Eagle Road King	110 CI		KN-171C*	VRSCX V-Rod	76 CI	HD-1102	KN-174C*
			SS-171	XL50 50th Anniversary Sportster	74 CI	HD-8834 ♦	KN-170C^
						HD-8834 ♦	SS-171
FLHRSE3 Screamin Eagle Road King - OEM 2944299A/B/C/D	110 CI	HD-0800	KN-171C*	XL883 Sportster	54 CI	HD-8834 ♦	KN-170C^
FLHT Electra Glide Standard	96 CI	HD-1499 ♦	KN-171C*			HD-8834 ♦	SS-171
		HD-1499 ♦	SS-171	XL883C Sportster Custom	54 CI	HD-8834	KN-170C^
FLHTC Electra Glide Classic	96 CI	HD-1499 ♦	KN-171C*			HD-8834	SS-171
		HD-1499 ♦	SS-171	XL883L Sportster Low	54 CI	HD-8834	KN-170C^
FLHTCI Electra Glide Classic F/I	88 CI	HD-1499	KN-171C*			HD-8834	SS-171
		HD-1499	SS-171	XL883R Sportster	54 CI	HD-8834 ♦	KN-170C^
FLHTCU Ultra Classic Electra Glide	96 CI	HD-1499 ♦	KN-171C*			HD-8834 ♦	SS-171
		HD-1499 ♦	SS-171	XL1200C Sportster Custom	74 CI	HD-8834 ♦	KN-170C^
FLHTCUSE2 Screamin Eagle Ultra Classic Electra Gli	110 CI		KN-171C*			HD-8834 ♦	SS-171
			SS-171	XL1200L Sportster Low	74 CI	HD-8834 ♦	KN-170C^
						HD-8834 ♦	SS-171
FLHTCUSE2 Screamin Eagle Ultra Classic Electra Gli - OEM 2944299A/B/C/D	110 CI	HD-0800	KN-171C*	XL1200N Sportster Nightster	74 CI	HD-8834 ♦	KN-170C^
FLHTP Electra Glide Police	103 CI	HD-1499				HD-8834 ♦	SS-171
FLHX Street Glide	96 CI	HD-1499 ♦	KN-171C*	XL1200R Sportster Roadster	74 CI	HD-8834 ♦	KN-170C^
		HD-1499 ♦	SS-171			HD-8834 ♦	SS-171
FLSTC Heritage Softail Classic	96 CI	HD-1499 ♦	KN-171C*	<b>2006 HARLEY DAVIDSON</b>			
		HD-1499 ♦	SS-171	FLHR Road King	88 CI	HD-1499	KN-171C*
FLSTF Fat Boy	96 CI	HD-1499 ♦	KN-171C*			HD-1499	SS-171
		HD-1499 ♦	SS-171	FLHRCI Road King Classic F/I	88 CI	HD-1499 ♦	KN-171C*
FLSTN Softail Deluxe	96 CI	HD-1499 ♦	KN-171C*			HD-1499 ♦	SS-171
		HD-1499 ♦	SS-171	FLHRI Road King F/I	88 CI	HD-1499 ♦	KN-171C*
FLSTSC Softail Springer Classic	96 CI	HD-1499 ♦	KN-171C*			HD-1499 ♦	SS-171
		HD-1499 ♦	SS-171	FLHRS Road King Custom	88 CI	HD-1499	KN-171C*
FLTR Road Glide	96 CI	HD-1499 ♦	KN-171C*			HD-1499	SS-171
		HD-1499 ♦	SS-171	FLHRSI Road King Custom F/I	88 CI	HD-1499 ♦	KN-171C*
FXD Dyna Super Glide	96 CI	HD-1499 ♦	KN-171C*			HD-1499 ♦	SS-171
		HD-1499 ♦	SS-171	FLHT Electra Glide Standard	88 CI	HD-1499	KN-171C*
FXDB Dyna Street Bob	96 CI	HD-1499 ♦	KN-171C*			HD-1499	SS-171
		HD-1499 ♦	SS-171	FLHTCI Electra Glide Classic F/I	88 CI	HD-1499 ♦	KN-171C*
FXDC Super Glide Custom	96 CI	HD-1499 ♦	KN-171C*			HD-1499 ♦	SS-171
		HD-1499 ♦	SS-171	FLHTCUI Electra Glide Ultra Classic F/I	88 CI	HD-1499 ♦	KN-171C*
FXDL Dyna Low Rider	96 CI	HD-1499 ♦	KN-171C*			HD-1499 ♦	SS-171
		HD-1499 ♦	SS-171	FLHTCUSE Screamin Eagle Ultra Classic Electra Glid	103 CI	HD-1499	
FXDSE Screamin Eagle Dyna	110 CI		KN-171C*	FLHTI Electra Glide Standard F/I	88 CI	HD-1499 ♦	KN-171C*
			SS-171			HD-1499 ♦	SS-171
FXDSE Screamin Eagle Dyna - OEM 2944299A/B/C/D	110 CI	HD-0800	KN-171C*	FLHX Street Glide	88 CI	HD-1499	KN-171C*
FXDWG Dyna Wide Glide	96 CI	HD-1499 ♦	KN-171C*			HD-1499	SS-171
		HD-1499 ♦	SS-171	FLHXI Street Glide F/I	88 CI	HD-1499 ♦	KN-171C*
FXST Softail Standard	96 CI	HD-1499 ♦	KN-171C*			HD-1499 ♦	SS-171
		HD-1499 ♦	SS-171	FLST Heritage Softail	88 CI	HD-1499	KN-171C*
FXSTB Night Train	96 CI	HD-1499 ♦	KN-171C*			HD-1499	SS-171
		HD-1499 ♦	SS-171	FLSTC Heritage Softail Classic	88 CI	HD-1499	
FXSTC Softail Custom	96 CI	HD-1499 ♦	KN-171C*	FLSTCI Heritage Softail Classic F/I	88 CI	HD-1499 ♦	KN-171C*
		HD-1499 ♦	SS-171			HD-1499 ♦	SS-171
				FLSTF Fat Boy	88 CI	HD-1499	KN-171C*

♦ Intake Available - See Pages 10-13    ^ Use KN-170 for Black    \* Change C to B for Black    Applications updated daily at [knfilters.com](http://knfilters.com) ®

**Partial Listing - Complete List of Vehicles and Applications at [knfilters.com](http://knfilters.com)**

# American V-Twin - Air & Oil Filters

Vehicle	Engine	Air Filter	Oil Filter	Vehicle	Engine	Air Filter	Oil Filter
<b>2006 HARLEY DAVIDSON</b>				<b>2006 HARLEY DAVIDSON</b>			
FLSTF Fat Boy	88 CI	HD-1499	SS-171	XL1200C Sportster Custom	74 CI	HD-8834	SS-171
FLSTF Fat Boy	96 CI		KN-171C*	XL1200L Sportster Low	74 CI	HD-8834	KN-170C^
			SS-171			HD-8834	SS-171
FLSTFI Fat Boy F/I	88 CI	HD-1499	◆ KN-171C*	XL1200R Sportster Roadster	74 CI	HD-8834	KN-170C^
		HD-1499	◆ SS-171			HD-8834	SS-171
FLSTI Heritage Softail F/I	88 CI	HD-1499	◆ KN-171C*	XLH883 Sportster	54 CI		KN-170C^
		HD-1499	◆ SS-171				SS-171
FLSTN Softail Deluxe	88 CI	HD-1499	KN-171C*	XLH883 Sportster Custom	54 CI	HD-8834	KN-170C^
		HD-1499	SS-171			HD-8834	SS-171
FLSTNI Softail Deluxe F/I	88 CI	HD-1499	◆ KN-171C*	XLH883L Sportster Low	54 CI		KN-170C^
		HD-1499	◆ SS-171				SS-171
FLSTSC Softail Springer Classic	88 CI	HD-1499	KN-171C*	XLH883R Sportster R	54 CI		KN-170C^
		HD-1499	SS-171				SS-171
FLSTSCI Softail Springer Classic F/I	88 CI	HD-1499	◆ KN-171C*	<b>2005 HARLEY DAVIDSON</b>			
		HD-1499	◆ SS-171	FLHR Road King	88 CI	HD-1499	KN-171C*
FLTR Road Glide	88 CI		KN-171C*			HD-1499	SS-171
			SS-171	FLHRCI Road King Classic F/I	88 CI	HD-1499	◆ KN-171C*
FLTRI Road Glide F/I	88 CI	HD-1499	◆ KN-171C*			HD-1499	◆ SS-171
		HD-1499	◆ SS-171	FLHRI Road King F/I	88 CI	HD-1499	◆ KN-171C*
FXDBI Street Bob F/I	88 CI	HD-1499	◆ KN-171C*			HD-1499	◆ SS-171
		HD-1499	◆ SS-171	FLHRS Road King Custom	88 CI	HD-1499	KN-171C*
FXDCI Dyna Super Glide Custom F/I	88 CI	HD-1499	◆ KN-171C*			HD-1499	SS-171
		HD-1499	◆ SS-171	FLHRSI Road King Custom F/I	88 CI	HD-1499	◆ KN-171C*
FXDI Dyna Super Glide F/I	88 CI	HD-1499	◆ KN-171C*			HD-1499	◆ SS-171
		HD-1499	◆ SS-171	FLHT Electra Glide Standard	88 CI	HD-1499	KN-171C*
FXDI35 35th Anniv. Super Glide F/I	88 CI	HD-1499	◆ KN-171C*			HD-1499	SS-171
		HD-1499	◆ SS-171	FLHTC Electra Glide Classic	88 CI	HD-1499	KN-171C*
FXDL Dyna Low Rider	88 CI	HD-1499	KN-171C*			HD-1499	SS-171
		HD-1499	SS-171	FLHTCI Electra Glide Classic F/I	88 CI	HD-1499	◆ KN-171C*
FXDLI Dyna Low Rider F/I	88 CI	HD-1499	◆ KN-171C*			HD-1499	◆ SS-171
		HD-1499	◆ SS-171	FLHTCSE2 Screamin Eagle Electra Glide 2	103 CI		KN-171C*
FXDWG Dyna Wide Glide	88 CI	HD-1499	KN-171C*				SS-171
		HD-1499	SS-171	FLHTCSE2 Screamin Eagle Electra Glide 2 - OEM 2944299A/B/C/D	103 CI	HD-0800	KN-171C*
FXDWGI Dyna Wide Glide F/I	88 CI	HD-1499	◆ KN-171C*	FLHTCSE2 Screamin Eagle Electra Glide 2 - OEM 2946199	103 CI	HD-1499	KN-171C*
		HD-1499	◆ SS-171	FLHTCUI Electra Glide Ultra Classic F/I	88 CI	HD-1499	◆ KN-171C*
FXST Softail Standard	88 CI	HD-1499	KN-171C*			HD-1499	◆ SS-171
		HD-1499	SS-171	FLHTI Electra Glide Standard F/I	88 CI	HD-1499	◆ KN-171C*
FXSTB Night Train	88 CI	HD-1499	KN-171C*			HD-1499	◆ SS-171
		HD-1499	SS-171	FLSTC Heritage Softail Classic	88 CI	HD-1499	
FXSTBI Night Train F/I	88 CI	HD-1499	◆ KN-171C*	FLSTCI Heritage Softail Classic F/I	88 CI	HD-1499	◆ KN-171C*
		HD-1499	◆ SS-171			HD-1499	◆ SS-171
FXSTD Softail Deuce	88 CI	HD-1499	KN-171C*	FLSTF Fat Boy	88 CI	HD-1499	KN-171C*
		HD-1499	SS-171			HD-1499	SS-171
FXSTDI Softail Deuce F/I	88 CI	HD-1499	◆ KN-171C*	FLSTF Fat Boy	96 CI		KN-171C*
		HD-1499	◆ SS-171				SS-171
FXSTI Softail Standard F/I	88 CI	HD-1499	◆ KN-171C*	FLSTFI Fat Boy F/I	88 CI	HD-1499	◆ KN-171C*
		HD-1499	◆ SS-171			HD-1499	◆ SS-171
FXSTS Springer Softail	88 CI	HD-1499	KN-171C*	FLSTFI Fat Boy F/I 15th Anniv.	95 CI	HD-0800	KN-171C*
		HD-1499	SS-171			HD-0800	SS-171
FXSTSI Springer Softail F/I	88 CI	HD-1499	◆ KN-171C*	FLSTFSE Screamin Eagle Fat Boy	103 CI	HD-0800	KN-171C*
		HD-1499	◆ SS-171			HD-0800	SS-171
VRSCA V-Rod	69 CI	HD-1102	KN-174C*	FLSTN Softail Deluxe	88 CI	HD-1499	KN-171C*
VRSCD Night Rod	69 CI	HD-1102	KN-174C*			HD-1499	SS-171
VRSCR Street Rod	69 CI	HD-1102	KN-174C*	FLSTNI Softail Deluxe F/I	88 CI	HD-1499	◆ KN-171C*
VRSCSE2 Screamin Eagle V-Rod	76 CI	HD-1102	KN-174C*			HD-1499	◆ SS-171
XL883 Sportster	54 CI	HD-8834	KN-170C^	FLSTSC Softail Springer Classic	88 CI	HD-1499	KN-171C*
		HD-8834	SS-171			HD-1499	SS-171
XL883C Sportster Custom	54 CI	HD-8834	KN-170C^	FLSTSCI Softail Springer Classic F/I	88 CI	HD-1499	◆ KN-171C*
		HD-8834	SS-171			HD-1499	◆ SS-171
XL883L Sportster Low	54 CI	HD-8834	KN-170C^				
		HD-8834	SS-171				
XL883R Sportster	54 CI	HD-8834	KN-170C^				
		HD-8834	SS-171				
XL1200C Sportster Custom	74 CI	HD-8834	KN-170C^				

◆ Intake Available - See Pages 10-13    ^ Use KN-170 for Black    \* Change C to B for Black    Applications updated daily at [knfilters.com](http://knfilters.com) ®



# American V-Twin - Air & Oil Filters

Vehicle	Engine	Air Filter	Oil Filter	Vehicle	Engine	Air Filter	Oil Filter
<b>2005 HARLEY DAVIDSON</b>				<b>2004 HARLEY DAVIDSON</b>			
FLTR Road Glide	88 CI		KN-171C* SS-171	FLHRS Road King Custom	88 CI	HD-1499	SS-171
FLTRI Road Glide F/I	88 CI	HD-1499 ♦	KN-171C* HD-1499 ♦ SS-171	FLHRSI Road King Custom F/I	88 CI	HD-1499 ♦	KN-171C* SS-171
FXD Dyna Super Glide	88 CI	HD-1499		FLHT Electra Glide Standard	88 CI	HD-1499	KN-171C* HD-1499 SS-171
FXDCI Dyna Super Glide Custom F/I	88 CI	HD-1499 ♦	KN-171C* HD-1499 ♦ SS-171	FLHTC Electra Glide Classic	88 CI	HD-1499	KN-171C* HD-1499 SS-171
FXDI Dyna Super Glide F/I	88 CI	HD-1499 ♦	KN-171C* HD-1499 ♦ SS-171	FLHTCI Electra Glide Classic F/I	88 CI	HD-1499 ♦	KN-171C* HD-1499 ♦ SS-171
FXDL Dyna Low Rider	88 CI	HD-1499	KN-171C* HD-1499 SS-171	FLHTCSE Screamin Eagle Electra Glide	103 CI		KN-171C* SS-171
FXDLI Dyna Low Rider F/I	88 CI	HD-1499 ♦	KN-171C* HD-1499 ♦ SS-171	FLHTCUI Electra Glide Ultra Classic F/I	88 CI	HD-1499 ♦	KN-171C* HD-1499 ♦ SS-171
FXDWG Dyna Wide Glide	88 CI	HD-1499	KN-171C* HD-1499 SS-171	FLHTI Electra Glide Standard F/I	88 CI	HD-1499 ♦	KN-171C* HD-1499 ♦ SS-171
FXDWGI Dyna Wide Glide F/I	88 CI	HD-1499 ♦	KN-171C* HD-1499 ♦ SS-171	FLSTC Heritage Softail Classic	88 CI	HD-1499	KN-171C* HD-1499 SS-171
FXDXI Dyna Super Glide Sport F/I	88 CI	HD-1499 ♦	KN-171C* HD-1499 ♦ SS-171	FLSTCI Heritage Softail Classic F/I	88 CI	HD-1499 ♦	KN-171C* HD-1499 ♦ SS-171
FXST Softail Standard	88 CI	HD-1499	KN-171C* HD-1499 SS-171	FLSTF Fat Boy	88 CI	HD-1499	KN-171C* HD-1499 SS-171
FXSTB Night Train	88 CI	HD-1499	KN-171C* HD-1499 SS-171	FLSTF Fat Boy	96 CI		KN-171C* SS-171
FXSTBI Night Train F/I	88 CI	HD-1499 ♦	KN-171C* HD-1499 ♦ SS-171	FLSTFI Fat Boy F/I	88 CI	HD-1499 ♦	KN-171C* HD-1499 ♦ SS-171
FXSTD Softail Deuce	88 CI	HD-1499	KN-171C* HD-1499 SS-171	FLTR Road Glide	88 CI		KN-171C* SS-171
FXSTDI Softail Deuce F/I	88 CI	HD-1499 ♦	KN-171C* HD-1499 ♦ SS-171	FLTRI Road Glide F/I	88 CI	HD-1499 ♦	KN-171C* HD-1499 ♦ SS-171
FXSTI Softail Standard F/I	88 CI	HD-1499 ♦	KN-171C* HD-1499 ♦ SS-171	FXD Dyna Super Glide	88 CI	HD-1499	
FXSTS Springer Softail	88 CI	HD-1499	KN-171C* HD-1499 SS-171	FXDI Dyna Super Glide F/I	88 CI	HD-1499 ♦	KN-171C* HD-1499 ♦ SS-171
FXSTSI Springer Softail F/I	88 CI	HD-1499 ♦	KN-171C* HD-1499 ♦ SS-171	FXDL Dyna Low Rider	88 CI	HD-1499	KN-171C* HD-1499 SS-171
VRSCA V-Rod	69 CI	HD-1102	KN-174C*	FXDLI Dyna Low Rider F/I	88 CI	HD-1499 ♦	KN-171C* HD-1499 ♦ SS-171
VRSCB V-Rod	69 CI	HD-1102	KN-174C*	FXDWG Dyna Wide Glide	88 CI	HD-1499	KN-171C* HD-1499 SS-171
VRSCSE Screamin Eagle V-Rod	76 CI	HD-1102	KN-174C*	FXDWGI Dyna Wide Glide F/I	88 CI	HD-1499 ♦	KN-171C* HD-1499 ♦ SS-171
XL883 Sportster	54 CI	HD-8834	KN-170C^ HD-8834 SS-171	FXDX Dyna Super Glide Sport	88 CI	HD-1499	KN-171C* HD-1499 SS-171
XL883C Sportster Custom	54 CI	HD-8834	KN-170C^ HD-8834 SS-171	FXDXI Dyna Super Glide Sport F/I	88 CI	HD-1499 ♦	KN-171C* HD-1499 ♦ SS-171
XL883L Sportster Low	54 CI	HD-8834	KN-170C^ HD-8834 SS-171	FXST Softail Standard	88 CI	HD-1499	KN-171C* HD-1499 SS-171
XL883R Sportster	54 CI	HD-8834	KN-170C^ HD-8834 SS-171	FXSTB Night Train	88 CI	HD-1499	KN-171C* HD-1499 SS-171
XL1200C Sportster Custom	74 CI	HD-8834	KN-170C^ HD-8834 SS-171	FXSTBI Night Train F/I	88 CI	HD-1499 ♦	KN-171C* HD-1499 ♦ SS-171
XL1200R Sportster Roadster	74 CI	HD-8834	KN-170C^ HD-8834 SS-171	FXSTD Softail Deuce	88 CI	HD-1499	KN-171C* HD-1499 SS-171
XLH883 Sportster	54 CI		KN-170C^ SS-171	FXSTDI Softail Deuce F/I	88 CI	HD-1499 ♦	KN-171C* HD-1499 ♦ SS-171
XLH883 Sportster Custom	54 CI		KN-170C^ SS-171	FXSTDSE2 Screamin Eagle Softail Deuce 2	95 CI		KN-171C* SS-171
XLH883L Sportster Low	54 CI		KN-170C^ SS-171	FXSTI Softail Standard F/I	88 CI	HD-1499 ♦	KN-171C* HD-1499 ♦ SS-171
<b>2004 HARLEY DAVIDSON</b>				FXSTS Springer Softail	88 CI	HD-1499	KN-171C*
FLHR Road King	88 CI	HD-1499	KN-171C* HD-1499 SS-171				
FLHRCI Road King Classic F/I	88 CI	HD-1499 ♦	KN-171C* HD-1499 ♦ SS-171				
FLHRI Road King F/I	88 CI	HD-1499 ♦	KN-171C* HD-1499 ♦ SS-171				
FLHRS Road King Custom	88 CI	HD-1499	KN-171C*				

♦ Intake Available - See Pages 10-13    ^ Use KN-170 for Black    \* Change C to B for Black    Applications updated daily at [knfilters.com](http://knfilters.com) ®

**Partial Listing - Complete List of Vehicles and Applications at [knfilters.com](http://knfilters.com)**

# American V-Twin - Air & Oil Filters

Vehicle	Engine	Air Filter	Oil Filter	Vehicle	Engine	Air Filter	Oil Filter
<b>2004 HARLEY DAVIDSON</b>				<b>2003 HARLEY DAVIDSON</b>			
FXSTS Springer Softail	88 CI	HD-1499	SS-171	FLTRI Road Glide F/I	88 CI	HD-1499 ♦	SS-171
FXSTSI Springer Softail F/I	88 CI	HD-1499 ♦	KN-171C*	FXD Dyna Super Glide	88 CI	HD-1499	KN-171C*
		HD-1499 ♦	SS-171			HD-1499	SS-171
VRSCA V-Rod	69 CI	HD-1102	KN-174C*	FXDL Dyna Low Rider	88 CI	HD-1499	KN-171C*
VRSCB V-Rod	69 CI	HD-1102	KN-174C*			HD-1499	SS-171
XL883 Sportster	54 CI	HD-8834	KN-170C^	FXDWG Dyna Wide Glide	88 CI	HD-1499	KN-171C*
		HD-8834	SS-171			HD-1499	SS-171
XL883C Sportster Custom	54 CI	HD-8834	KN-170C^	FXDX Dyna Super Glide Sport	88 CI	HD-1499	KN-171C*
		HD-8834	SS-171			HD-1499	SS-171
XL883L Sportster Low	54 CI		KN-170C^	FXDXT Dyna Super Glide T-Sport	88 CI	HD-1499	KN-171C*
			SS-171			HD-1499	SS-171
XL883R Sportster	54 CI		KN-170C^	FXST Softail Standard	88 CI	HD-1499	KN-171C*
			SS-171			HD-1499	SS-171
XL1200C Sportster Custom	74 CI	HD-8834	KN-170C^	FXSTB Night Train	88 CI	HD-1499	KN-171C*
		HD-8834	SS-171			HD-1499	SS-171
XL1200R Sportster Roadster	74 CI	HD-8834	KN-170C^	FXSTBI Night Train F/I	88 CI	HD-1499 ♦	KN-171C*
		HD-8834	SS-171			HD-1499 ♦	SS-171
XLH883 Sportster	54 CI		KN-170C^	FXSTD Softail Deuce	88 CI	HD-1499	KN-171C*
			SS-171			HD-1499	SS-171
XLH883 Sportster Custom	54 CI		KN-170C^	FXSTDI Softail Deuce F/I	88 CI	HD-1499 ♦	KN-171C*
			SS-171			HD-1499 ♦	SS-171
<b>2003 HARLEY DAVIDSON</b>				FXSTDSE Screamin Eagle Softail Deuce	95 CI		KN-171C*
FLHR Road King	88 CI	HD-1499	KN-171C*				SS-171
		HD-1499	SS-171				
FLHRCI Road King Classic F/I	88 CI	HD-1499 ♦	KN-171C*	FXSTI Softail Standard F/I	88 CI	HD-1499 ♦	KN-171C*
		HD-1499 ♦	SS-171			HD-1499 ♦	SS-171
FLHRI Road King F/I	88 CI	HD-1499 ♦	KN-171C*	FXSTS Springer Softail	88 CI	HD-1499	KN-171C*
		HD-1499 ♦	SS-171			HD-1499	SS-171
FLHT Electra Glide Standard	88 CI	HD-1499	KN-171C*	FXSTSI Springer Softail F/I	88 CI	HD-1499 ♦	KN-171C*
		HD-1499	SS-171			HD-1499 ♦	SS-171
FLHTC Electra Glide Classic	88 CI	HD-1499	KN-171C*	VRSCA V-Rod	69 CI	HD-1102	KN-174C*
		HD-1499	SS-171	XL53C Sportster Custom	54 CI		KN-170C^
FLHTCI Electra Glide Classic F/I	88 CI	HD-1499 ♦	KN-171C*				SS-171
		HD-1499 ♦	SS-171	XL883C Sportster Custom	54 CI	HD-1388	KN-170C^
FLHTCSE Screamin Eagle Electra Glide	103 CI		KN-171C*			HD-1388	SS-171
			SS-171	XL883R Sportster	54 CI	HD-1388	KN-170C^
						HD-1388	SS-171
FLHTCUI Electra Glide Ultra Classic F/I	88 CI	HD-1499 ♦	KN-171C*	XL1200C Sportster Custom	74 CI	HD-1388	KN-170C^
		HD-1499 ♦	SS-171			HD-1388	SS-171
				XL1200S Sportster Sport	74 CI	HD-1388	KN-170C^
						HD-1388	SS-171
FLHTI Electra Glide Standard F/I	88 CI	HD-1499 ♦	KN-171C*	XLH883 Sportster	54 CI	HD-1388	KN-170C^
		HD-1499 ♦	SS-171			HD-1388	SS-171
FLHTSEI Screamin Eagle Road King F/I	103 CI		KN-171C*	XLH883 Sportster Custom	54 CI	HD-1388	KN-170C^
			SS-171			HD-1388	SS-171
				XLH883 Sportster Hugger	54 CI	HD-1388	KN-170C^
						HD-1388	SS-171
FLSTC Heritage Softail Classic	88 CI	HD-1499	KN-171C*	XLH1200 Sportster	73 CI	HD-1388	KN-170C^
		HD-1499	SS-171			HD-1388	SS-171
FLSTCI Heritage Softail Classic F/I	88 CI	HD-1499 ♦	KN-171C*	<b>2002 HARLEY DAVIDSON</b>			
		HD-1499 ♦	SS-171	FLHR Road King	88 CI	HD-1499	KN-171C*
FLSTF Fat Boy	88 CI	HD-1499	KN-171C*			HD-1499	SS-171
		HD-1499	SS-171	FLHRCI Road King Classic F/I	88 CI	HD-1499 ♦	KN-171C*
FLSTF Fat Boy	96 CI		KN-171C*			HD-1499 ♦	SS-171
			SS-171	FLHRI Road King F/I	88 CI	HD-1499	KN-171C*
FLSTFI Fat Boy F/I	88 CI	HD-1499 ♦	KN-171C*			HD-1499	SS-171
		HD-1499 ♦	SS-171	FLHT Electra Glide Standard	88 CI	HD-1499	KN-171C*
FLSTS Heritage Springer	88 CI	HD-1499	KN-171C*			HD-1499	SS-171
		HD-1499	SS-171	FLHTC Electra Glide Classic	88 CI	HD-1499	KN-171C*
FLSTSI Heritage Springer F/I	88 CI	HD-1499 ♦	KN-171C*			HD-1499	SS-171
		HD-1499 ♦	SS-171	FLHTCI Electra Glide Classic F/I	88 CI	HD-1499 ♦	KN-171C*
FLTR Road Glide	88 CI		KN-171C*			HD-1499 ♦	SS-171
			SS-171				
FLTRI Road Glide F/I	88 CI	HD-1499 ♦	KN-171C*				

♦ Intake Available - See Pages 10-13    ^ Use KN-170 for Black    \* Change C to B for Black    Applications updated daily at [knfilters.com](http://knfilters.com) ®

# American V-Twin - Air & Oil Filters

Vehicle	Engine	Air Filter	Oil Filter	Vehicle	Engine	Air Filter	Oil Filter
<b>2002 HARLEY DAVIDSON</b>				<b>2002 HARLEY DAVIDSON</b>			
FLHTCUI Electra Glide Ultra Classic F/I	88 CI	HD-1499 ♦	KN-171C*	XLH1200 Sportster	74 CI	HD-1388	SS-171
		HD-1499 ♦	SS-171	<b>2001 HARLEY DAVIDSON</b>			
FLSTC Heritage Softail Classic	88 CI	HD-1499	KN-171C*	FLHR Road King	88 CI	HD-1499	KN-171C*
		HD-1499	SS-171			HD-1499	SS-171
FLSTCI Heritage Softail Classic F/I	88 CI	HD-1499 ♦	KN-171C*	FLHRCI Road King Classic F/I	88 CI	HD-8899	KN-171C*
		HD-1499 ♦	SS-171			HD-8899	SS-171
FLSTF Fat Boy	88 CI	HD-1499	KN-171C*	FLHRI Electra Glide Road King F/I	88 CI	HD-8899	KN-171C*
		HD-1499	SS-171			HD-8899	SS-171
FLSTFI Fat Boy F/I	88 CI	HD-1499 ♦	KN-171C*	FLHRI Road King F/I	88 CI	HD-8899	KN-171C*
		HD-1499 ♦	SS-171			HD-8899	SS-171
FLSTS Heritage Springer	88 CI	HD-1499	KN-171C*	FLHT Electra Glide	82 CI		KN-171C*
		HD-1499	SS-171				SS-171
FLSTSI Heritage Springer F/I	88 CI	HD-1499 ♦	KN-171C*	FLHT Electra Glide Standard	88 CI	HD-1499	KN-171C*
		HD-1499 ♦	SS-171			HD-1499	SS-171
FLTR Road Glide	88 CI	HD-1499	KN-171C*	FLHTC Electra Glide Classic	88 CI	HD-1499	KN-171C*
		HD-1499	SS-171			HD-1499	SS-171
FLTRI Road Glide F/I	88 CI	HD-1499 ♦	KN-171C*	FLHTCI Electra Glide Classic F/I	88 CI	HD-8899	KN-171C*
		HD-1499 ♦	SS-171			HD-8899	SS-171
FXD Dyna Super Glide	88 CI	HD-1499	KN-171C*	FLHTCUI Electra Glide Ultra Classic F/I	88 CI	HD-8899	KN-171C*
		HD-1499	SS-171			HD-8899	SS-171
FXDL Dyna Low Rider	88 CI	HD-1499	KN-171C*	FLSTC Heritage Softail Classic	88 CI	HD-1499	KN-171C*
		HD-1499	SS-171			HD-1499	SS-171
FXDWG Dyna Wide Glide	88 CI	HD-1499	KN-171C*	FLSTCI Heritage Softail Classic F/I	88 CI	HD-8899	KN-171C*
		HD-1499	SS-171			HD-8899	SS-171
FXDX Dyna Super Glide Sport	88 CI	HD-1499	KN-171C*	FLSTF Fat Boy	88 CI	HD-1499	KN-171C*
		HD-1499	SS-171			HD-1499	SS-171
FXDXT Dyna Super Glide T-Sport	88 CI	HD-1499	KN-171C*	FLSTFI Fat Boy F/I	88 CI	HD-1499 ♦	KN-171C*
		HD-1499	SS-171			HD-1499 ♦	SS-171
FXST Softail Standard	88 CI	HD-1499	KN-171C*	FLSTS Heritage Springer	88 CI	HD-1499	KN-171C*
		HD-1499	SS-171			HD-1499	SS-171
FXSTB Night Train	88 CI	HD-1499	KN-171C*	FLSTSI Heritage Springer F/I	88 CI	HD-1499 ♦	KN-171C*
		HD-1499	SS-171			HD-1499 ♦	SS-171
FXSTBI Night Train F/I	88 CI	HD-1499 ♦	KN-171C*	FLTR Road Glide	88 CI	HD-1499	KN-171C*
		HD-1499 ♦	SS-171			HD-1499	SS-171
FXSTD Softail Deuce	88 CI	HD-1499	KN-171C*	FLTRI Road Glide F/I	88 CI	HD-8899	KN-171C*
		HD-1499	SS-171			HD-8899	SS-171
FXSTDI Softail Deuce F/I	88 CI	HD-1499 ♦	KN-171C*	FLTRSEI2 Screamin Eagle Road Glide 2 F/I	95 CI	HD-0800	KN-171C*
		HD-1499 ♦	SS-171			HD-0800	SS-171
FXSTI Softail Standard F/I	88 CI	HD-1499 ♦	KN-171C*	FXD Dyna Super Glide	88 CI	HD-1499	KN-171C*
		HD-1499 ♦	SS-171			HD-1499	SS-171
FXSTS Springer Softail	88 CI	HD-1499	KN-171C*	FXDL Dyna Low Rider	88 CI	HD-1499	KN-171C*
		HD-1499	SS-171			HD-1499	SS-171
FXSTSI Springer Softail F/I	88 CI	HD-1499 ♦	KN-171C*	FXDWG Dyna Wide Glide	88 CI	HD-1499	KN-171C*
		HD-1499 ♦	SS-171			HD-1499	SS-171
VRSCA V-Rod	69 CI	HD-1102	KN-174C*	FXDWG3	88 CI	HD-1499	KN-171C*
XL53C Sportster Custom	54 CI		KN-170C^			HD-1499	SS-171
			SS-171	FXDX Dyna Super Glide Sport	88 CI	HD-1499	KN-171C*
XL883C Sportster Custom	54 CI	HD-1388	KN-170C^			HD-1499	SS-171
		HD-1388	SS-171	FXDXT Dyna Super Glide T-Sport	88 CI	HD-1499	KN-171C*
XL883R Sportster	54 CI	HD-1388	KN-170C^			HD-1499	SS-171
		HD-1388	SS-171	FXST Softail Standard	88 CI	HD-1499	KN-171C*
XL1200C Sportster Custom	74 CI	HD-1388	KN-170C^			HD-1499	SS-171
		HD-1388	SS-171	FXSTB Night Train	88 CI	HD-1499	KN-171C*
XL1200S Sportster Sport	74 CI	HD-1388	KN-170C^			HD-1499	SS-171
		HD-1388	SS-171	FXSTBI Night Train F/I	88 CI	HD-1499 ♦	KN-171C*
XLH883 Sportster	54 CI	HD-1388	KN-170C^			HD-1499 ♦	SS-171
		HD-1388	SS-171	FXSTD Softail Deuce	88 CI	HD-1499	KN-171C*
XLH883 Sportster Custom	54 CI	HD-1388	KN-170C^			HD-1499	SS-171
		HD-1388	SS-171	FXSTDI Softail Deuce F/I	88 CI	HD-1499 ♦	KN-171C*
XLH883 Sportster Hugger	54 CI	HD-1388	KN-170C^			HD-1499 ♦	SS-171
		HD-1388	SS-171			HD-1499 ♦	SS-171
XLH1200 Sportster	74 CI	HD-1388	KN-170C^				

♦ Intake Available - See Pages 10-13    ^ Use KN-170 for Black    \* Change C to B for Black    Applications updated daily at [knfilters.com](http://knfilters.com) ®

**Partial Listing - Complete List of Vehicles and Applications at [knfilters.com](http://knfilters.com)**

# American V-Twin - Air & Oil Filters

Vehicle	Engine	Air Filter	Oil Filter	Vehicle	Engine	Air Filter	Oil Filter
<b>2001 HARLEY DAVIDSON</b>				<b>2000 HARLEY DAVIDSON</b>			
FXSTI Softail Standard F/I	88 CI	HD-1499 ♦	KN-171C* HD-1499 ♦	FXSTB Night Train	88 CI	HD-1499	KN-171C* SS-171
FXSTS Springer Softail	88 CI	HD-1499	KN-171C* HD-1499	FXSTC Softail Custom	82 CI		KN-171C* SS-171
FXSTSI Springer Softail F/I	88 CI	HD-1499 ♦	KN-171C* HD-1499 ♦	FXSTD Softail Deuce	88 CI	HD-1499	KN-171C* HD-1499
XL53C Sportster Custom	54 CI		KN-170C^ SS-171	FXSTS Springer Softail	88 CI	HD-1499	KN-171C* SS-171
XL1200C Sportster Custom	74 CI	HD-1388	KN-170C^ HD-1388	XL53C Sportster Custom	54 CI	HD-1388	KN-170C^ SS-171
XL1200S Sportster Sport	74 CI	HD-1388	KN-170C^ HD-1388	XL1200C Sportster Custom	74 CI	HD-1388	KN-170C^ SS-171
XLH883 Sportster	54 CI	HD-1388	KN-170C^ HD-1388	XL1200S Sportster Sport	74 CI	HD-1388	KN-170C^ SS-171
XLH883 Sportster Custom	54 CI	HD-1388	KN-170C^ HD-1388	XLH883 Sportster	54 CI	HD-1388	KN-170C^ SS-171
XLH883 Sportster Hugger	54 CI	HD-1388	KN-170C^ HD-1388	XLH883 Sportster Custom	54 CI	HD-1388	KN-170C^ SS-171
XLH1200 Sportster	74 CI	HD-1388	KN-170C^ HD-1388	XLH883 Sportster Hugger	54 CI	HD-1388	KN-170C^ SS-171
<b>2000 HARLEY DAVIDSON</b>				XLH883R Sportster Flat Track	54 CI	HD-1388	KN-170C^ SS-171
FLHR Road King	88 CI	HD-1499	KN-171C* HD-1499	XLH1200 Sportster	74 CI	HD-1388	KN-170C^ SS-171
FLHRCI Road King Classic F/I	88 CI	HD-8899	KN-171C* HD-8899	<b>2016 INDIAN</b>			
FLHRI Electra Glide Road King F/I	88 CI	HD-8899	KN-171C* HD-8899	Chief Classic	111 CI	PL-1814	
FLHRI Road King F/I	88 CI	HD-8899		Chief Dark Horse	111 CI	PL-1814	
FLHT Electra Glide	82 CI		KN-171C* SS-171	Chief Vintage	111 CI	PL-1814	
FLHT Electra Glide Standard	88 CI	HD-1499	KN-171C* HD-1499	Chieftain	111 CI	PL-1814	
FLHTC Electra Glide Classic	88 CI	HD-1499	KN-171C* HD-1499	Roadmaster	111 CI	PL-1814	
FLHTCI Electra Glide Classic F/I	88 CI	HD-8899	KN-171C* HD-8899	Scout	69 CI	PL-1115	
FLHTCUI Electra Glide Ultra Classic F/I	88 CI	HD-8899	KN-171C* HD-8899	Scout Sixty	69 CI	PL-1115	
FLSTC Heritage Softail Classic	88 CI	HD-1499	KN-171C* HD-1499	<b>2015 INDIAN</b>			
FLSTF Fat Boy	88 CI	HD-1499	KN-171C* HD-1499	Chief Classic	111 CI	PL-1814	
FLSTS Heritage Springer	88 CI	HD-1499	KN-171C* HD-1499	Chief Vintage	111 CI	PL-1814	
FLTR Road Glide	88 CI	HD-1499	KN-171C* HD-1499	Chieftain	111 CI	PL-1814	
FLTRI Road Glide F/I	88 CI	HD-8899	KN-171C* HD-8899	Roadmaster	111 CI	PL-1814	
FXD Dyna Super Glide	88 CI	HD-1499	KN-171C* HD-1499	Scout	69 CI	PL-1115	
FXDL Dyna Low Rider	88 CI	HD-1499	KN-171C* HD-1499	<b>2014 INDIAN</b>			
FXDS Dyna Convertible	88 CI	HD-1499	KN-171C* HD-1499	Chief Classic	111 CI	PL-1814	
FXDWG Dyna Wide Glide	88 CI	HD-1499	KN-171C* HD-1499	Chief Vintage	111 CI	PL-1814	
FXDWG2	88 CI	HD-1499	KN-171C* HD-1499	Chieftain	111 CI	PL-1814	
FXDX Dyna Super Glide Sport	88 CI	HD-1499	KN-171C* HD-1499	<b>2013 INDIAN</b>			
FXST Softail Standard	88 CI	HD-1499	KN-171C* HD-1499	Chief Classic	105 CI	E-3290	
				Chief Dark Horse	105 CI	E-3290	
				Chief Vintage	105 CI	E-3290	
				Chief Vintage FE	105 CI	E-3290	
				Chief Vintage LE	105 CI	E-3290	
				<b>2012 INDIAN</b>			
				Chief Classic	105 CI	E-3290	
				Chief Dark Horse	105 CI	E-3290	
				Chief Vintage	105 CI	E-3290	
				<b>2011 INDIAN</b>			
				Chief Blackhawk	105 CI	E-3290	
				Chief Blackhawk Dark	105 CI	E-3290	
				Chief Classic	105 CI	E-3290	
				Chief Dark Horse	105 CI	E-3290	
				Chief Roadmaster	105 CI	E-3290	
				Chief Vintage	105 CI	E-3290	
				<b>2010 INDIAN</b>			
				Chief Bomber	105 CI	E-3290	

♦ Intake Available - See Pages 10-13    ^ Use KN-170 for Black    \* Change C to B for Black    Applications updated daily at [knfilters.com](http://knfilters.com) ®

# American V-Twin - Air & Oil Filters

Vehicle	Engine	Air Filter	Oil Filter
<b>2010 INDIAN</b>			
Chief Classic	105 CI	E-3290	
Chief Dark Horse	105 CI	E-3290	
Chief Roadmaster	105 CI	E-3290	
Chief Vintage	105 CI	E-3290	
<b>2009 INDIAN</b>			
Chief Deluxe	105 CI	E-3290	
Chief Roadmaster	105 CI	E-3290	
Chief Standard	105 CI	E-3290	
Chief Vintage	105 CI	E-3290	
<b>2003 INDIAN</b>			
Chief	1638	E-3981	
Scout - w/S&S teardrop backplate & Indian teardrop cvr	1436	E-3971	
Spirit - w/S&S teardrop backplate & Indian teardrop cvr	1436	E-3971	
<b>2002 INDIAN</b>			
Chief	1638	E-3981	
Scout - w/S&S teardrop backplate & Indian teardrop cvr	1436	E-3971	
Spirit - w/S&S teardrop backplate & Indian teardrop cvr	1436	E-3971	
<b>2001 INDIAN</b>			
Scout - w/S&S teardrop backplate & Indian teardrop cvr	1436	E-3971	
Spirit - w/S&S teardrop backplate & Indian teardrop cvr	1436	E-3971	
<b>2000 INDIAN</b>			
Chief - w/S&S teardrop backplate & Indian teardrop cvr	1436	E-3971	
<b>2016 VICTORY</b>			
Cross Country	1731		KN-198
Cross Country 8-Ball	1731		KN-198
Cross Country Tour	1731		KN-198
Gunner	1731	PL-1608	KN-198
Hammer S	1731	PL-1608	KN-198
High-Ball	1731	PL-1608	KN-198
Magnum	1731		KN-198
Vegas	1731	PL-1608	
Vegas 8-Ball	1731	PL-1608	KN-198
Vision Tour	1731		KN-198
<b>2015 VICTORY</b>			
Cross Country	1731		KN-198
Cross Country 8-Ball	1731		KN-198
Cross Country Tour	1731		KN-198
Gunner	1731	PL-1608	KN-198
Hammer 8-Ball	1731	PL-1608	KN-198
High-Ball	1731	PL-1608	KN-198
Judge	1731	PL-1608	
Magnum	1731		KN-198
Ness Magnum	1731		KN-198
Vegas 8-Ball	1731	PL-1608	KN-198
Vision Tour	1731		KN-198
<b>2014 VICTORY</b>			
Boardwalk	1731	PL-1608	KN-198
Cross Country	1731		KN-198
Cross Country 8-Ball	1731	VEVELOPME	KN-198
Cross Country Tour	1731	VEVELOPME	KN-198
Cross Country Tour 15th Anniversary LE	1731	VEVELOPME	KN-198
Cross Roads 8-Ball	1731	VEVELOPME	KN-198
Cross Roads Classic	1731	VEVELOPME	KN-198

Vehicle	Engine	Air Filter	Oil Filter
<b>2014 VICTORY</b>			
Hammer 8-Ball	1731	PL-1608	KN-198
High-Ball	1731	PL-1608	KN-198
Jackpot	1731	PL-1608	KN-198
Judge	1731	PL-1608	KN-198
Ness Cross Country	1731	VEVELOPME	KN-198
Vegas 8-Ball	1731	PL-1608	KN-198
Vision Tour	1731		KN-198
<b>2013 VICTORY</b>			
Arlen Ness Vision	1731		KN-198
Boardwalk	1731	PL-1608	KN-198
Cross Country	1731	VEVELOPME	KN-198
Cross Country Cory Ness	1731	VEVELOPME	KN-198
Cross Country Tour	1731	VEVELOPME	KN-198
Cross Country Zach Ness	1731	VEVELOPME	KN-198
Cross Roads Classic	1731	VEVELOPME	KN-198
Hammer 8-Ball	1731	PL-1608	KN-198
Hard-Ball	1731	VEVELOPME	KN-198
High-Ball	1731	PL-1608	KN-198
Judge	1731	PL-1608	KN-198
Vegas 8-Ball	1731	PL-1608	KN-198
Vegas Jackpot	1731	PL-1608	KN-198
Vision Tour	1731		KN-198
<b>2012 VICTORY</b>			
Arlen Ness Vision	1731		KN-198
Cross Country	1731	VEVELOPME	KN-198
Cross Country Cory Ness	1731	VEVELOPME	KN-198
Cross Country Tour	1731	VEVELOPME	KN-198
Cross Roads	1731	VEVELOPME	KN-198
Hammer 8-Ball	1731	PL-1608	KN-198
Hammer S	1731	PL-1608	KN-198
Hard-Ball	1731		KN-198
High-Ball	1731	PL-1608	KN-198
Kingpin	1731	PL-1608	KN-198
Vegas	1731	PL-1608	KN-198
Vegas 8-Ball	1731	PL-1608	KN-198
Vegas Jackpot	1731	PL-1608	KN-198
Vegas Zach Ness	1731	PL-1608	KN-198
Vision Tour	1731		KN-198
<b>2011 VICTORY</b>			
Cross Country	1731	VEVELOPME	KN-198
Cross Country Cory Ness	1731	VEVELOPME	KN-198
Cross Roads	1731	VEVELOPME	KN-198
Hammer	1731	PL-1608	KN-198
Hammer 8-Ball	1731	PL-1608	KN-198
Hammer S	1731	PL-1608	KN-198
High-Ball	1731	PL-1608	KN-198
Kingpin	1731	PL-1608	KN-198
Kingpin 8-Ball	1731	PL-1608	KN-198
Vegas	1731	PL-1608	KN-198
Vegas 8-Ball	1731	PL-1608	KN-198
Vegas Jackpot	1731	PL-1608	KN-198
Vegas Zach Ness	1731	PL-1608	KN-198
Victory Vision Arlen Ness	1731		KN-198
Vision 8-Ball	1731		KN-198
Vision Tour	1731		KN-198
<b>2010 VICTORY</b>			
Arlen Ness Victory Vision	1731		KN-198
Cross Country	1731		KN-198
Cross Roads	1731		KN-198
Hammer	1731	PL-1608	KN-198
Hammer 8-Ball	1731	PL-1608	KN-198
Hammer S	1731	PL-1608	KN-198

# American V-Twin - Air & Oil Filters

Vehicle	Engine	Air Filter	Oil Filter
<b>2010 VICTORY</b>			
Jackpot Cory Ness	1731	PL-1608	KN-198
Kingpin	1634	PL-1608	KN-198
Kingpin 8-Ball	1634	PL-1608	KN-198
Kingpin Low	1634	PL-1608	
Kingpin Tour	1634	PL-1608	
Vegas	1634	PL-1608	KN-198
Vegas 8-Ball	1634	PL-1608	KN-198
Vegas Jackpot	1731	PL-1608	KN-198
Vegas Low	1634	PL-1608	
Vision 8-Ball	1731		KN-198
Vision Tour	1731		KN-198

<b>2009 VICTORY</b>			
Arlen Ness Vision	1731		KN-198
Hammer	1731	PL-1608	KN-198
Hammer S	1731	PL-1608	KN-198
Jackpot Cory Ness	1731	PL-1608	KN-198
Kingpin	1634	PL-1608	KN-198
Kingpin 8-Ball	1634	PL-1608	KN-198
Kingpin Low	1634	PL-1608	KN-198
Kingpin Tour	1634	PL-1608	KN-198
Vegas	1634	PL-1608	KN-198
Vegas 8-Ball	1634	PL-1608	KN-198
Vegas Jackpot	1731	PL-1608	KN-198
Vegas Low	1634	PL-1608	KN-198
Victory Vision Arlen Ness	1731		KN-198
Vision Street	1731		KN-198
Vision Street Premium	1731		KN-198
Vision Tour	1731		KN-198
Vision Tour 10th Anniversary	1731		KN-198

<b>2008 VICTORY</b>			
Hammer	1634	PL-1608	KN-198
Hammer S	1634	PL-1608	KN-198
Jackpot Arlen Ness	1634	PL-1608	KN-198
Jackpot Cory Ness	1634	PL-1608	
Jackpot Ness Signature Series	1634		KN-198
Kingpin	1634	PL-1608	KN-198
Kingpin 8-Ball	1634	PL-1608	
Kingpin Tour	1634	PL-1608	
Vegas	1634	PL-1608	KN-198
Vegas 8-Ball	1634	PL-1608	KN-198
Vegas Jackpot	1634	PL-1608	KN-198
Vegas Low	1634	PL-1608	
Vision Street	1731		KN-198
Vision Tour	1731		KN-198

<b>2007 VICTORY</b>			
Hammer	1634	PL-1500	KN-198
Hammer S	1634	PL-1500	KN-198
Jackpot Ness Signature Series	1634	PL-1500	KN-198
Kingpin	1634	PL-1500	KN-198
Kingpin Tour	1634	PL-1500	
Vegas	1634	PL-1500	KN-198
Vegas 8-Ball	1634	PL-1500	KN-198
Vegas Jackpot	1634	PL-1500	KN-198

<b>2006 VICTORY</b>			
Hammer	1634	PL-1500	KN-198
Jackpot Ness Signature Series	1634	PL-1500	KN-198
Kingpin	1634	PL-1500	KN-198
Touring Cruiser	1508	PL-1500	KN-198
Vegas	1634	PL-1500	KN-198
Vegas 8-Ball	1634	PL-1500	KN-198
Vegas Jackpot	1634	PL-1500	KN-198

Vehicle	Engine	Air Filter	Oil Filter
<b>2005 VICTORY</b>			
Hammer	1634	PL-1500	KN-198
Kingpin	1507	PL-1500	KN-198
Kingpin Ness Signature Series	1507	PL-1500	KN-198
Touring Cruiser	1508	PL-1500	KN-198
Vegas	1507	PL-1500	KN-198
Vegas 8-Ball	1507	PL-1500	KN-198
Vegas Ness Signature Series	1507	PL-1500	KN-198
<b>2004 VICTORY</b>			
Kingpin	1507	PL-1500	KN-198
Touring Cruiser	1508	PL-1500	KN-198
Vegas	1507	PL-1500	KN-198

<b>2003 VICTORY</b>			
Classic Cruiser	1508	PL-1500	KN-198
Kingpin	1634		KN-198
Touring Cruiser	1508	PL-1500	KN-198
Vegas	1507	PL-1500	KN-198

<b>2002 VICTORY</b>			
Deluxe Cruiser	1508	PL-1500	KN-198
Deluxe Touring Cruiser	1508	PL-1500	KN-198
Standard Cruiser	1507	PL-1500	KN-198
Touring Cruiser	1508	PL-1500	KN-198

<b>2001 VICTORY</b>			
V92C	1508	PL-1500	KN-303
		PL-1500	KN-303C
V92C Deluxe	1507	PL-1500	KN-303
		PL-1500	KN-303C
V92SC	1507	PL-1500	KN-303
		PL-1500	KN-303C

<b>2000 VICTORY</b>			
V92C	1508	PL-1500	KN-303
		PL-1500	KN-303C
V92SC	1507	PL-1500	KN-303
		PL-1500	KN-303C

# Motorcycle - Application Listing

CC	Model	Year	Air Filter	Air Filter Precharger	Custom	Custom Precharger	Oil Filter	Comments
<b>APRILIA</b>								
125	RS4	11-12					KN-563	
449	RXV 450 Enduro	06-08	AL-4506				KN-563	
449	RXV 450 Enduro	09-12					KN-563	
449	SXV 450	06-10	AL-4506				KN-563	
450	MXV450	08-14					KN-575	
549	RXV 550 Enduro	06-08	AL-4506				KN-563	
549	RXV 550 Enduro	09-12					KN-563	
549	SXV 550	06-11	AL-4506				KN-563	
549	SXV 550	12					KN-563	
649	Pegaso 650 Strada	05	AL-6505				KN-145	
649	Pegaso 650 Trail	06	AL-6505				KN-145	
652	Pegaso 650	93-96					KN-151	
652	Pegaso 650	97-00	AL-6502				KN-151	
652	Pegaso 650 i.e.	01-04	AL-6502				KN-151	
660	Pegaso 650	07-08	AL-6505				KN-145	
660	Pegaso 650 Trail	08	AL-6505				KN-145	
660	Pegaso 660	05-12					KN-145	
750	Shiver 750	08-15					KN-184	
750	SL750 Shiver ABS	08-14					KN-184	
839	Mana 850	08-15	MG-0001					
839	Mana 850 GT ABS	09-15	MG-0001					
998	ETV1000 Caponord	01-03	AL-1002				KN-152*	*OEM AP0256187
998	ETV1000 Caponord	01-03	AL-1002				KN-564*	*OEM AP0956745
998	ETV1000 Caponord	04-05	AL-1002				KN-152	
998	ETV1000 Caponord	06-07	AL-1002				KN-152*	*OEM AP0256187
998	ETV1000 Caponord	06-07	AL-1002				KN-564*	*OEM AP0956745
998	ETV1000 Caponord	08	AL-1002				KN-152	
998	RST1000 Futura	01	AL-1098				KN-152	
998	RST1000 Futura	02	AL-1098				KN-152*	*OEM AP0256187
998	RST1000 Futura	02	AL-1098				KN-564*	*OEM AP0956745
998	RST1000 Futura	03	AL-1098				KN-152	
998	RST1000 Futura	04	AL-1098				KN-152*	*OEM AP0256187
998	RST1000 Futura	04	AL-1098				KN-564*	*OEM AP0956745
998	RST1000 Futura	05					KN-152	
998	RSV 1000 R	05-09	AL-1004				KN-152*	*OEM AP0256187
998	RSV 1000 R	05-09	AL-1004				KN-564*	*OEM AP0956745
998	RSV 1000 R	10-13	AL-1004				KN-138*	*Chrome=KN-138C
998	RSV Mille	98-99	AL-1098				KN-152	
998	RSV Mille	00	AL-1098				KN-152*	*OEM AP0256187
998	RSV Mille	00	AL-1098				KN-564*	*OEM AP0956745
998	RSV Mille	01-02	AL-1001				KN-152*	*OEM AP0256187
998	RSV Mille	01-02	AL-1001				KN-564*	*OEM AP0956745
998	RSV Mille	03	AL-1001				KN-152	
998	RSV Mille	04	AL-1004				KN-152*	*OEM AP0256187
998	RSV Mille	04	AL-1004				KN-564*	*OEM AP0956745
998	RSV Mille R	00	AL-1001				KN-152*	*OEM AP0256187
998	RSV Mille R	00	AL-1001				KN-564*	*OEM AP0956745
998	RSV Mille R	01-02					KN-152*	*OEM AP0256187
998	RSV Mille R	01-02					KN-564*	*OEM AP0956745
998	RSV Mille R	04					KN-152*	*OEM AP0256187
998	RSV Mille R	04					KN-564*	*OEM AP0956745
998	RSV Mille R Haga	03					KN-152*	*OEM AP0256187
998	RSV Mille R Haga	03					KN-564*	*OEM AP0956745
998	RSV Mille R Nera	04					KN-152*	*OEM AP0256187
998	RSV Mille R Nera	04					KN-564*	*OEM AP0956745
998	RSV Mille SP	00					KN-152*	*OEM AP0256187
998	RSV Mille SP	00					KN-564*	*OEM AP0956745

2) Requires Two; 3) Requires Three; 4) Requires Four. The use of custom air filter requires removal of air box. Some custom filters and intakes are not legal for sale or use on any pollution controlled motor vehicle in California or states adopting California emission procedures. See knfilters.com for CARB status on each part for a specific vehicle.

# Motorcycle - Application Listing

CC	Model	Year	Air Filter	Air Filter Precharger	Custom	Custom Precharger	Oil Filter	Comments
<b>APRILIA</b>								
998	RSV Mille SP	01	AL-1098				KN-152*	*OEM AP0256187
998	RSV Mille SP	01	AL-1098				KN-564*	*OEM AP0956745
998	RSV Tuono	04-05	AL-1001				KN-152*	*OEM AP0256187
998	RSV Tuono	04-05	AL-1001				KN-564*	*OEM AP0956745
998	SL1000 Falco	00	AL-1098				KN-152	
998	SL1000 Falco	01	AL-1098				KN-152*	*OEM AP0256187
998	SL1000 Falco	01	AL-1098				KN-564*	*OEM AP0956745
998	SL1000 Falco	02	AL-1098				KN-152	
998	SL1000 Falco	03	AL-1098				KN-152*	*OEM AP0256187
998	SL1000 Falco	03	AL-1098				KN-564*	*OEM AP0956745
998	SL1000 Falco	04	AL-1098				KN-152	
998	SL1000 Falco	05-08					KN-152	
998	Tuono 1000 R	06-09	AL-1004				KN-152*	*OEM AP0256187
998	Tuono 1000 R	06-09	AL-1004				KN-564*	*OEM AP0956745
998	Tuono Fighter	03	AL-1001				KN-152*	*OEM AP0256187
998	Tuono Fighter	03	AL-1001				KN-564*	*OEM AP0956745
999	RSV4 RF1000	16					KN-138*	*Chrome=KN-138C
999	RSV4 RR1000	16					KN-138*	*Chrome=KN-138C
1000	RSV4 Factory	09	AL-1010					
1000	RSV4 Factory	09	AL-1010R*					*Race Specific
1000	RSV4 Factory	10	AL-1010				KN-138*	*Chrome=KN-138C
1000	RSV4 Factory	10	AL-1010R*				KN-138**	*Race Specific/ **Chrome=KN-138C
1000	RSV4 Factory SE	11-12	AL-1010					
1000	RSV4 Factory SE	11-12	AL-1010R*					*Race Specific
1000	RSV4 R	10	AL-1010					
1000	RSV4 R	10	AL-1010R*					*Race Specific
1000	RSV4 R	11	AL-1010				KN-138*	*Chrome=KN-138C
1000	RSV4 R	11	AL-1010R*				KN-138**	*Race Specific/ **Chrome=KN-138C
1000	RSV4 R	12	AL-1010					
1000	RSV4 R	12	AL-1010R*					*Race Specific
1000	Tuono 1000 R	10	AL-1004				KN-152*	*OEM AP0256187
1000	Tuono 1000 R	10	AL-1004				KN-564*	*OEM AP0956745
1000	Tuono 1000 R	11	AL-1004					
1000	Tuono V4 R	11	AL-1010				KN-138*	*Chrome=KN-138C
1000	Tuono V4 R	11	AL-1010R*				KN-138**	*Race Specific/ **Chrome=KN-138C
1000	Tuono V4 R	12	AL-1010					
1000	Tuono V4 R	12	AL-1010R*					*Race Specific
1000	Tuono V4 R	13	AL-1010				KN-138*	*Chrome=KN-138C
1000	Tuono V4 R	13	AL-1010R*				KN-138**	*Race Specific/ **Chrome=KN-138C
1000	Tuono V4 R APRC	12-13	AL-1010					
1000	Tuono V4 R APRC	12-13	AL-1010R*					*Race Specific
1077	Tuono V4 1100 Factory	15	AL-1010					
1077	Tuono V4 1100 Factory	15	AL-1010R*					*Race Specific
1077	Tuono V4 1100RR	15	AL-1010					
1077	Tuono V4 1100RR	15	AL-1010R*					*Race Specific
1077	Tuono V4 1100RR	16					KN-138*	*Chrome=KN-138C
<b>BMW</b>								
450	G450X	09-12					KN-611	
647	C600 Sport	14	BM-6012				KN-164	
647	C600 Sport	15	BM-6012					
650	F650	99					KN-151	
650	F650 Enduro	99					KN-151	
650	F650 Funduro	93-00					KN-151	
650	F650 SE	99					KN-151	

2) Requires Two; 3) Requires Three; 4) Requires Four. The use of custom air filter requires removal of air box. Some custom filters and intakes are not legal for sale or use on any pollution controlled motor vehicle in California or states adopting California emission procedures. See knfilters.com for CARB status on each part for a specific vehicle.



# Motorcycle - Application Listing

CC	Model	Year	Air Filter	Air Filter Precharger	Custom	Custom Precharger	Oil Filter	Comments
<b>BMW</b>								
650	F650GS	01-03	BM-6501				KN-151	
650	F650GS ABS	00-03	BM-6501				KN-151	
650	F650ST	97-99					KN-151	
650	F650ST Strada	00					KN-151	
650	G650 Xchallenge	07-11	BM-6507				KN-151	
650	G650 Xcountry	07-10	BM-6507				KN-151	
650	G650 Xmoto	07-10	BM-6507				KN-151	
650	G650GS	09-15	BM-6501				KN-151	
650	G650GS	16	BM-6501					
650	G650GS Sertao	12-15	BM-6501				KN-151	
650	R65	78-95	BM-0300				KN-161	
652	F650CS	01	BM-6507					
652	F650CS	02-05	BM-6507				KN-151	
652	F650CS	06					KN-151	
652	F650CS ABS	03-05	BM-6507				KN-151	
652	F650GS	04-07	BM-6501				KN-151	
652	F650GS	08-09	BM-8006				KN-164	
652	F650GS ABS	05	BM-6501				KN-151	
740	K75	90-95	BM-2605				KN-163	
740	K75A	94	BM-2605				KN-163	
750	K75	88-89	BM-2605				KN-163	
750	K75	96-97	BM-2605				KN-163	
750	K75 ABS	94	BM-2605				KN-163	
750	K75 ABS Special Edition	94	BM-2605				KN-163	
750	K75 Special Edition	94	BM-2605				KN-163	
750	K75/3	95	BM-2605				KN-163	
750	K75/3 ABS	95	BM-2605				KN-163	
750	K75C	85-88	BM-2605				KN-163	
750	K75RT	90-97	BM-2605				KN-163	
750	K75RT ABS	91-95	BM-2605				KN-163	
750	K75S	86-97	BM-2605				KN-163	
750	K75S ABS	91-95	BM-2605				KN-163	
750	K75T	86-87	BM-2605				KN-163	
798	F650GS	10-12	BM-8006				KN-164	
798	F700GS	13-14	BM-8006				KN-164	
798	F700GS	15	BM-8006				KN-160	
798	F800GS	07-14	BM-8006				KN-164	
798	F800GS	15	BM-8006				KN-160	
798	F800GS Adventure	14	BM-8006				KN-164	
798	F800GS Adventure	15	BM-8006				KN-160	
798	F800GS Adventure	16	BM-8006					
798	F800GT	13-14	BM-8006				KN-164	
798	F800GT	15	BM-8006				KN-160	
798	F800GT	16	BM-8006					
798	F800R	09-14	BM-8006				KN-164	
798	F800R	15	BM-8006				KN-160	
798	F800S	06-09	BM-8006				KN-164	
798	F800S	10-11	BM-8006					
798	F800ST	06-09	BM-8006				KN-164	
798	F800ST	10-12	BM-8006					
800	R80	85-89	BM-0300				KN-161	
800	R80	95	BM-0300				KN-161	
800	R80GS	80-95	BM-0300				KN-161	
800	R80R	93-95	BM-0300				KN-161	
800	R80RT	85-95	BM-0300				KN-161	
800	R80ST	82-86	BM-0300				KN-161	
800	R80ST	87-90					KN-161	

2) Requires Two; 3) Requires Three; 4) Requires Four. The use of custom air filter requires removal of air box. Some custom filters and intakes are not legal for sale or use on any pollution controlled motor vehicle in California or states adopting California emission procedures. See knfilters.com for CARB status on each part for a specific vehicle.

# Motorcycle - Application Listing

CC	Model	Year	Air Filter	Air Filter Precharger	Custom	Custom Precharger	Oil Filter	Comments
<b>BMW</b>								
806	R80	90-91	BM-0300				KN-161	
806	R80	93-94	BM-0300				KN-161	
806	R80R	92	BM-0300				KN-161	
832	R850R	95-03	BM-0400				KN-163	
832	R850R ABS	96	BM-0400				KN-163	
832	R850R Special Edition	97	BM-0400				KN-163	
850	R850C	99-00					KN-163	
850	R850GS Boxer	99					KN-163	
850	R850R	04-05					KN-163	
850	R850R	06	BM-0400				KN-163	
850	R850R Boxer	99					KN-163	
850	R850R Classic	02-04					KN-163	
850	R850RT	99					KN-163	
900	R900RT	05	BM-1204				KN-164	
990	S1000RR	09	BM-1010				KN-164	
990	S1000RR	09	BM-1010R*				KN-164	*Race Specific
990	S1000RR	10-13	BM-1010				KN-160	
990	S1000RR	10-13	BM-1010R*				KN-160	*Race Specific
999	HP4	12	BM-1010					
999	HP4	12	BM-1010R*					*Race Specific
999	HP4	13-14	BM-1010				KN-160	
999	HP4	13-14	BM-1010R*				KN-160	*Race Specific
999	HP4 Competition	14	BM-1010				KN-160	
999	HP4 Competition	14	BM-1010R*				KN-160	*Race Specific
999	S1000R	14	BM-1010				KN-164	
999	S1000R	14	BM-1010R*				KN-164	*Race Specific
999	S1000R	15	BM-1010				KN-160	
999	S1000R	15	BM-1010R*				KN-160	*Race Specific
999	S1000R	16	BM-1010					
999	S1000R	16	BM-1010R*					*Race Specific
999	S1000RR	14	BM-1010				KN-164	
999	S1000RR	14	BM-1010R*				KN-164	*Race Specific
999	S1000RR	15	BM-1010					
999	S1000RR	15	BM-1010R*					*Race Specific
1000	K1	89-93	BM-2605				KN-163	
1000	K1	94					KN-163	
1000	K100	83-89	BM-2605				KN-163	
1000	K100	90					KN-163	
1000	K100LT	83-93	BM-2605				KN-163	
1000	K100LT	94					KN-163	
1000	K100LT ABS	89-92	BM-2605				KN-163	
1000	K100RS	83-88	BM-2605				KN-163	
1000	K100RS	90	BM-2605				KN-163	
1000	K100RS	93	BM-2605				KN-163	
1000	K100RS	94					KN-163	
1000	K100RS ABS	88-89	BM-2605				KN-163	
1000	K100RS FL	91-92	BM-2605				KN-163	
1000	K100RS FL ABS	91-92	BM-2605				KN-163	
1000	K100RT	83-89	BM-2605				KN-163	
1000	K100RT	90-94					KN-163	
1000	R100CS	85-90					KN-161*	*w/o oil cooler
1000	R100GS	87-94	BM-0300				KN-161*	*w/o oil cooler
1000	R100GS	95	BM-0300					
1000	R100MYS	91-95	BM-0300					
1000	R100PD	87-95	BM-0300					
1000	R100R	87-90					KN-161*	*w/o oil cooler
1000	R100R	91-95	BM-0300				KN-161*	*w/o oil cooler

2) Requires Two; 3) Requires Three; 4) Requires Four. The use of custom air filter requires removal of air box. Some custom filters and intakes are not legal for sale or use on any pollution controlled motor vehicle in California or states adopting California emission procedures. See knfilters.com for CARB status on each part for a specific vehicle.

# Motorcycle - Application Listing

CC	Model	Year	Air Filter	Air Filter Precharger	Custom	Custom Precharger	Oil Filter	Comments
<b>BMW</b>								
1000	R100R	96					KN-161*	*w/o oil cooler
1000	R100RS	87-95	BM-0300				KN-161*	*w/o oil cooler
1000	R100RS	96					KN-161*	*w/o oil cooler
1000	R100RT	87-96	BM-0300				KN-161*	*w/o oil cooler
1000	R100S	86-90					KN-161*	*w/o oil cooler
1100	K1100LT	93-99	BM-2605				KN-163	
1100	K1100LT ABS	92	BM-2605				KN-163	
1100	K1100LT ABS Special Edition	94	BM-2605				KN-163	
1100	K1100LT ABS Special Edition	97	BM-2605				KN-163	
1100	K1100LT High Line	97	BM-2605				KN-163	
1100	K1100RS	90-95	BM-2605				KN-163	
1100	K1100RS	96-97	BM-2605					
1100	K1100RS SE	96	BM-2605					
1100	R1100GS	94-95	BM-0400				KN-163	
1100	R1100GS ABS	93	BM-0400				KN-163	
1100	R1100GS ABS	95-99	BM-0400				KN-163	
1100	R1100GS PD	98					KN-163	
1100	R1100GS SE	99	BM-0400				KN-163	
1100	R1100R	95-00	BM-0400				KN-163	
1100	R1100R ABS	95-98	BM-0400				KN-163	
1100	R1100R ABS	00	BM-0400				KN-163	
1100	R1100R SE	99	BM-0400				KN-163	
1100	R1100RA/S ABS	95	BM-0400				KN-163	
1100	R1100RL	01	BM-0400				KN-163	
1100	R1100RS	93-94	BM-0400				KN-163	
1100	R1100RS ABS	94-01	BM-0400				KN-163	
1100	R1100RSL	94-96	BM-0400					
1100	R1100RSL ABS	97	BM-0400					
1100	R1100RSL ABS Special Edition	94-95	BM-0400					
1100	R1100RT	94-95	BM-0400				KN-163	
1100	R1100RT	96-98	BM-0400					
1100	R1100RT	99-01	BM-0400				KN-163	
1100	R1100RT SE	00	BM-0400				KN-163	
1100	R1100RTL	96-97	BM-0400					
1100	R1100S	98	BM-0400				KN-163	
1100	R1100S	99-05	BM-1199				KN-163	
1100	R1100S ABS	99	BM-1199				KN-163	
1100	R1100S ABS	02	BM-1199				KN-163	
1100	R1100S ABS	04-05	BM-1199				KN-163	
1100	R1100S Prep	04					KN-163	
1100	R1100SA	00-01	BM-1199				KN-163	
1100	R1100SA SE	00	BM-1199				KN-163	
1150	R1150GS	99-03	BM-0400				KN-163	
1150	R1150GS	04-05					KN-163	
1150	R1150GS Adventure	02-05	BM-0400				KN-163	
1150	R1150GS Sport	03	BM-0400				KN-163	
1150	R1150R	01-06	BM-0400				KN-163	
1150	R1150RS	01-05	BM-0400				KN-163	
1150	R1150RS SE	02					KN-163	
1150	R1150RT	01-05	BM-0400				KN-163	
1157	K1200GT	02-04	BM-1299					
1157	K1200GT	05	BM-1299				KN-160	
1157	K1200GT	06-08	BM-1205				KN-160	
1157	K1200R Sport	07	BM-1205				KN-160	
1157	K1200S	05-08	BM-1205 <sup>2</sup>				KN-160	
1170	HP2 Enduro	05-08	BM-1204				KN-164	
1170	HP2 Megamoto	07-08	BM-1204				KN-164	

2) Requires Two; 3) Requires Three; 4) Requires Four. The use of custom air filter requires removal of air box. Some custom filters and intakes are not legal for sale or use on any pollution controlled motor vehicle in California or states adopting California emission procedures. See knfilters.com for CARB status on each part for a specific vehicle.

# Motorcycle - Application Listing

CC	Model	Year	Air Filter	Air Filter Precharger	Custom	Custom Precharger	Oil Filter	Comments
<b>BMW</b>								
1170	HP2 Megamoto	10-11	BM-1204				KN-164	
1170	HP2 Sport	08-11	BM-1208				KN-164	
1170	K1200LT	04-08	BM-1299				KN-163	
1170	K1200LT	09	BM-1299					
1170	R nineT	14-15	BM-1204				KN-164	
1170	R nineT	16	BM-1204					
1170	R nineT Scrambler	16	BM-1204					
1170	R1200C	98-02	BM-1298				KN-163	
1170	R1200C Classic	97-00	BM-1298				KN-163	
1170	R1200C Euro	98-02	BM-1298				KN-163	
1170	R1200C Independent	00	BM-1298				KN-163	
1170	R1200C Montana	00-03	BM-1298				KN-163	
1170	R1200C Phoenix	00	BM-1298				KN-163	
1170	R1200C Phoenix	02	BM-1298				KN-163	
1170	R1200C Stiletto	01	BM-1298				KN-163	
1170	R1200CL	02	BM-1298				KN-163	
1170	R1200GS	04-09	BM-1204				KN-164	
1170	R1200GS	13	BM-1113*				KN-160	*Water Cooled Eng.
1170	R1200GS	13	BM-1204*				KN-160	*Air Cooled Eng.
1170	R1200GS Adventure	05-09	BM-1204				KN-164	
1170	R1200GS HP2	05-08	BM-1204				KN-164	
1170	R1200R	07-09	BM-1204				KN-164	
1170	R1200R	15	BM-1113*				KN-160	*Liquid Cooled Eng.
1170	R1200RS	15	BM-1113*					*Liquid Cooled Eng.
1170	R1200RS	15	BM-1204*					*Air Cooled Eng.
1170	R1200RS	16	BM-1113					
1170	R1200RT	05-09	BM-1204				KN-164	
1170	R1200S	06-07	BM-1204				KN-164	
1170	R1200S	09	BM-1204				KN-164	
1170	R1200ST	05-07	BM-1204				KN-164	
1171	K1200R	08	BM-1205				KN-160	
1171	K1200R Sport	08	BM-1205				KN-160	
1200	K1200C	99					KN-163	
1200	K1200C	02	BM-1299					
1200	K1200LT	98-03	BM-1299				KN-163	
1200	K1200LT ABS	02	BM-1299				KN-163	
1200	K1200LT Exodus	03	BM-1299				KN-163	
1200	K1200LT Lux	02	BM-1299				KN-163	
1200	K1200LT SE	02	BM-1299				KN-163	
1200	K1200LT SE	05	BM-1299				KN-163	
1200	K1200LTC	99-02	BM-1299				KN-163	
1200	K1200LTI Icon	99-01	BM-1299				KN-163	
1200	K1200LTS	99-00	BM-1299				KN-163	
1200	K1200R	05-07	BM-1205				KN-160	
1200	K1200RS	97-04	BM-1299				KN-163	
1200	K1200RS	05	BM-1299				KN-160	
1200	K1200RS SE	02-04					KN-163	
1200	K1200RS SE	05					KN-160	
1200	R1200 HP2 Sport	08-10	BM-1208				KN-164	
1200	R1200C	04	BM-1298				KN-163	
1200	R1200C Avantgarde	00					KN-163	
1200	R1200C Avantgarde	01-02	BM-1298				KN-163	
1200	R1200C Avantgarde	03					KN-163	
1200	R1200C Classic	01-03	BM-1298				KN-163	
1200	R1200C Classic	04-05					KN-163	
1200	R1200C Independent	01-03	BM-1298				KN-163	
1200	R1200C Independent	04					KN-163	

2) Requires Two; 3) Requires Three; 4) Requires Four. The use of custom air filter requires removal of air box. Some custom filters and intakes are not legal for sale or use on any pollution controlled motor vehicle in California or states adopting California emission procedures. See knfilters.com for CARB status on each part for a specific vehicle.

# Motorcycle - Application Listing

CC	Model	Year	Air Filter	Air Filter Precharger	Custom	Custom Precharger	Oil Filter	Comments
<b>BMW</b>								
1200	R1200C Montauk	03-04	BM-1298				KN-163	
1200	R1200C Montauk	05					KN-163	
1200	R1200C Phoenix	01	BM-1298				KN-163	
1200	R1200C Phoenix	04					KN-163	
1200	R1200CL	03-06	BM-1298				KN-163	
1200	R1200GS	10-12	BM-1204				KN-164	
1200	R1200GS	14-15	BM-1113				KN-160	
1200	R1200GS	16	BM-1113					
1200	R1200GS Adventure	10-12	BM-1204				KN-164	
1200	R1200GS Adventure	13	BM-1204				KN-160	
1200	R1200GS Adventure	14-15	BM-1113				KN-160	
1200	R1200GS Adventure	16	BM-1113					
1200	R1200R	10-12	BM-1204				KN-164	
1200	R1200R	13-14	BM-1204				KN-160	
1200	R1200R	15	BM-1204*				KN-160	*Air Cooled Eng.
1200	R1200R Classic	11	BM-1204				KN-164	
1200	R1200RT	10-13	BM-1204				KN-164	
1200	R1200RT	14-15	BM-1113				KN-160	
1200	R1200RT	16	BM-1113					
1200	R1200S	10-11	BM-1204				KN-164	
1300	K1300GT	09-11	BM-1205				KN-160	
1300	K1300GT SE	10	BM-1205				KN-160	
1300	K1300R	09-14	BM-1205				KN-160	
1300	K1300R	15	BM-1205					
1300	K1300S	09-15	BM-1205				KN-160	
1300	K1300S	16	BM-1205					
1600	K1600GT	11-13	BM-1611					
1600	K1600GT	14-15	BM-1611				KN-164	
1600	K1600GT	16	BM-1611					
1600	K1600GT Sport	14	BM-1611				KN-164	
1600	K1600GTL	11-13	BM-1611					
1600	K1600GTL	14-15	BM-1611				KN-164	
1600	K1600GTL	16	BM-1611					
1600	K1600GTL Exclusive	14-15	BM-1611				KN-164	
<b>CAN-AM</b>								
990	Spyder GS - SE5	08	CM-9908				KN-559*	*Transmission Filter
990	Spyder GS - SE5	08	CM-9908				KN-564	
990	Spyder GS - SM5	08	CM-9908				KN-559*	*Transmission Filter
990	Spyder GS - SM5	08	CM-9908				KN-564	
998	Spyder GS - SM5	09	CM-9908				KN-559*	*Transmission Filter
998	Spyder GS - SM5	09	CM-9908				KN-564	
998	Spyder RS	14-16	CM-9910					
998	Spyder RS SE5	09-11	CM-9908				KN-559*	*Transmission Filter
998	Spyder RS SE5	09-11	CM-9908				KN-564	
998	Spyder RS SE5	12					KN-559*	*Transmission Filter
998	Spyder RS SE5	12					KN-564	
998	Spyder RS SE5	13-14	CM-9910					
998	Spyder RS SM5	09-12	CM-9908				KN-559*	*Transmission Filter
998	Spyder RS SM5	09-12	CM-9908				KN-564	
998	Spyder RS SM5	13-15	CM-9910					
998	Spyder RS-S SE5	10-12	CM-9908				KN-559*	*Transmission Filter
998	Spyder RS-S SE5	10-12	CM-9908				KN-564	
998	Spyder RS-S SE5	13-15	CM-9910					
998	Spyder RS-S SM5	11-12	CM-9908				KN-559*	*Transmission Filter
998	Spyder RS-S SM5	11-12	CM-9908				KN-564	
998	Spyder RS-S SM5	13-15	CM-9910					
998	Spyder RT Limited SE5	10-12	CM-9910				KN-559*	*Transmission Filter

2) Requires Two; 3) Requires Three; 4) Requires Four. The use of custom air filter requires removal of air box. Some custom filters and intakes are not legal for sale or use on any pollution controlled motor vehicle in California or states adopting California emission procedures. See knfilters.com for CARB status on each part for a specific vehicle.

# Motorcycle - Application Listing

CC	Model	Year	Air Filter	Air Filter Precharger	Custom	Custom Precharger	Oil Filter	Comments
<b>CAN-AM</b>								
998	Spyder RT Limited SE5	10-13	CM-9910				KN-564	
998	Spyder RT SE5	10-11	CM-9910				KN-559*	*Transmission Filter
998	Spyder RT SE5	10-11	CM-9910				KN-564	
998	Spyder RT SE5	13	CM-9910				KN-564	
998	Spyder RT SE5 A/C	10-12	CM-9910				KN-559*	*Transmission Filter
998	Spyder RT SE5 A/C	10-12	CM-9910				KN-564	
998	Spyder RT SM5	10-12	CM-9910				KN-559*	*Transmission Filter
998	Spyder RT SM5	10-13	CM-9910				KN-564	
998	Spyder RT SM5 A/C	10-12	CM-9910				KN-559*	*Transmission Filter
998	Spyder RT SM5 A/C	10-12	CM-9910				KN-564	
998	Spyder RT-S SE5	12	CM-9910				KN-559*	*Transmission Filter
998	Spyder RT-S SE5	12-13	CM-9910				KN-564	
998	Spyder RT-S SM5	12	CM-9910				KN-559*	*Transmission Filter
998	Spyder RT-S SM5	12-13	CM-9910				KN-564	
998	Spyder ST	14-16	CM-9910					
998	Spyder ST Limited SE5	13-15	CM-9910					
998	Spyder ST SE5	13-14	CM-9910					
998	Spyder ST SM5	13-15	CM-9910					
998	Spyder ST-S SE5	13-15	CM-9910					
998	Spyder ST-S SM5	13-15	CM-9910					
1330	Spyder F3 SE6	15-16	CM-1314					
1330	Spyder F3 SM6	15-16	CM-1314					
1330	Spyder F3-S SE6	15-16	CM-1314					
1330	Spyder F3-S SM6	15-16	CM-1314					
1330	Spyder RT	16	CM-1314					
1330	Spyder RT Limited SE6	14-15	CM-1314					
1330	Spyder RT SE6	14-15	CM-1314					
1330	Spyder RT SM6	14-15	CM-1314					
1330	Spyder RT-S SE6	14-15	CM-1314					
1330	Spyder RT-S SM6	14-15	CM-1314					
<b>DUCATI</b>								
400	Monster 400	01-02	DU-9098				KN-153	
400	Monster 400	05					KN-153	
400	Monster 400	06-08	DU-9001				KN-153	
400	Monster 400 Dark	02-03	DU-9098				KN-153	
400	Monster 400 Dark	04					KN-153	
400	Monster 400 Dark i.e.	05	DU-9001				KN-153	
400	Monster 400 i.e.	05	DU-9001				KN-153	
400	Monster 400 Metallic	01	DU-9098				KN-153	
400	Monster 400s	03	DU-9098				KN-153	
583	600SS	91-98	DU-0900				KN-153	
583	600SS	99	DU-0900					
600	M600 Monster	93-97	DU-0900				KN-153	
600	Monster 600	98-01	DU-0900				KN-153	
600	Monster 600 City	99	DU-0900				KN-153	
600	Monster 600 Dark	98-01	DU-0900				KN-153	
600	Monster 600 Metallic	00-01	DU-0900				KN-153	
618	Monster 620	03-04	DU-9001				KN-153	
618	Monster 620 Capirex	04	DU-9001				KN-153	
618	Monster 620 Dark	03-04	DU-9001				KN-153	
618	Monster 620 Matrix	04	DU-9001				KN-153	
618	Multistrada 620	05	DU-1004				KN-153	
618	Multistrada 620 Dark	05	DU-1004				KN-153	
620	620 Sport	03	DU-9098				KN-153	
620	Monster 620	02	DU-9001				KN-153	
620	Monster 620	05-06	DU-9001				KN-153	
620	Monster 620 Dark	05-06	DU-9001				KN-153	

2) Requires Two; 3) Requires Three; 4) Requires Four. The use of custom air filter requires removal of air box. Some custom filters and intakes are not legal for sale or use on any pollution controlled motor vehicle in California or states adopting California emission procedures. See knfilters.com for CARB status on each part for a specific vehicle.

# Motorcycle - Application Listing

CC	Model	Year	Air Filter	Air Filter Precharger	Custom	Custom Precharger	Oil Filter	Comments
<b>DUCATI</b>								
620	Monster 620 Dark i.e.	04-05					KN-153	
620	Monster 620 i.e.	03-05					KN-153	
620	Monster 620s	02-03	DU-6202				KN-153	
620	Multistrada 620	06	DU-1004				KN-153	
620	Multistrada 620 Dark	06	DU-1004				KN-153	
650	650 Indiana Custom	86-88					KN-153	
659	Monster 659	11-12					KN-153*	*Australia
695	Monster 695	07	DU-9001				KN-153	
696	Monster 695	08	DU-9001				KN-153	
696	Monster 696	08-14	DU-6908				KN-153	
696	Monster 696 ABS	14	DU-6908				KN-153	
742	750SS	91-98	DU-0900				KN-153	
742	750SS	99	DU-9098				KN-153	
748	748	97-03					KN-153	
748	748 Biposto	95-99					KN-153	
748	748 SP	94-98					KN-153	
748	748 SPS	99					KN-153	
748	748R	00-02					KN-153	
748	748S	00-02					KN-153	
749	749	03-06					KN-153	
749	749 Dark	05-06					KN-153	
749	749R	04-06					KN-153	
749	749S	03-06					KN-153	
750	750 F1 MKII	85-87					KN-153	
750	750 Indiana Custom	87-88					KN-153	
750	750 Paso	86					KN-153	
750	750 Paso	87-88	DU-0900				KN-153	
750	750 Paso	89-90					KN-153	
750	750 Sport	88-90					KN-153	
750	750 Sport	01-02					KN-153	
750	750SS i.e.	00-02	DU-9098				KN-153	
750	M750 Monster	96	DU-9098				KN-153	
750	M750 Monster	97-98	DU-0900				KN-153	
750	Monster 750	99-01	DU-9098				KN-153	
750	Monster 750	02	DU-9001				KN-153	
750	Monster 750 City	99	DU-9098				KN-153	
750	Monster 750 Dark	99-01	DU-9098				KN-153	
750	Monster 750 Dark	02	DU-9001				KN-153	
750	Monster 750 Metallic	00-01	DU-9098				KN-153	
750	Monster 750 Metallic	02	DU-9001				KN-153	
795	Monster 795	12					KN-153	
796	Hypermotard 796	10-13	DU-1006				KN-153	
796	Monster 796	10-13	DU-6908				KN-153	
800	800 Sport	03	DU-9098				KN-153	
800	800SS	03	DU-9098				KN-153	
800	800SS	06-07	DU-9098				KN-153	
800	Monster 800	04	DU-9001				KN-153	
800	Monster 800 Dark	03					KN-153	
800	Monster 800s	03	DU-9001				KN-153	
803	800SS	04-05	DU-9098				KN-153	
803	Monster 750	10-11					KN-153	
803	Monster 796	14	DU-1006				KN-153	
803	Monster 796 ABS	14	DU-1006				KN-153	
803	Monster S2R	05-07	DU-9001				KN-153	
803	Monster S2R 800	07	DU-9001				KN-153	
803	Monster S2R Dark	05-06	DU-9001				KN-153	
803	Scrambler Classic	15-16					KN-153	

2) Requires Two; 3) Requires Three; 4) Requires Four. The use of custom air filter requires removal of air box. Some custom filters and intakes are not legal for sale or use on any pollution controlled motor vehicle in California or states adopting California emission procedures. See knfilters.com for CARB status on each part for a specific vehicle.

# Motorcycle - Application Listing

CC	Model	Year	Air Filter	Air Filter Precharger	Custom	Custom Precharger	Oil Filter	Comments
<b>DUCATI</b>								
803	Scrambler Full Throttle	15-16					KN-153	
803	Scrambler Icon	15-16					KN-153	
803	Scrambler Urban Enduro	15-16					KN-153	
821	Hypermotard	13-14	DU-1006				KN-153	
821	Hypermotard	15	DU-1006					
821	Hypermotard SP	13-14	DU-1006				KN-153	
821	Hypermotard SP	15	DU-1006					
821	Hyperstrada	13-15	DU-1006				KN-153	
821	Monster 821	15-16	DU-1006				KN-153	
821	Monster 821 Dark	15-16	DU-1006				KN-153	
821	Monster 821 Stripe	15-16	DU-1006				KN-153	
848	848	08-09	DU-1007				KN-153	
848	848	08-09	DU-1007R*				KN-153	*Race Specific
848	848 EVO	10-13	DU-1007				KN-153	
848	848 EVO	10-13	DU-1007R*				KN-153	*Race Specific
848	Streetfighter	12-15	DU-1007				KN-153	
848	Streetfighter	12-15	DU-1007R*				KN-153	*Race Specific
851	851 Strada	89-92					KN-153	
888	888 Strada	92-94					KN-153	
898	899 Panigale	13-14	DU-1112					
898	899 Panigale	13-14	DU-1112R*					*Race Specific
898	899 Panigale	15	DU-1112				KN-159	
898	899 Panigale	15	DU-1112R*				KN-159	*Race Specific
900	900 Sport	02					KN-153	
900	900SS FE	98	DU-0900				KN-153	
900	900SS i.e.	00-01	DU-9098				KN-153	
900	900SS i.e.	02	DU-0900				KN-153	
900	MH900e	02					KN-153	
900	Monster 900 City	99	DU-9098				KN-153	
900	Monster 900 Cromo	99	DU-9098				KN-153	
900	Monster 900 Cromo	00-01	DU-0900				KN-153	
900	Monster 900 Dark	00	DU-9098				KN-153	
900	Monster 900 Dark	02	DU-9098				KN-153	
900	Monster 900s	99-00	DU-9098				KN-153	
904	900 SuperLight	91	DU-0900					
904	900 SuperLight	92-97	DU-0900				KN-153	
904	900SS	90					KN-153	
904	900SS	91-98	DU-0900				KN-153	
904	900SS	99	DU-9098				KN-153	
904	MH900e	01					KN-153	
904	Monster 900	93-98	DU-0900				KN-153	
904	Monster 900	99-02	DU-9098				KN-153	
904	Monster 900 Cromo	98	DU-0900				KN-153	
904	Monster 900 Dark	98	DU-0900				KN-153	
904	Monster 900 Dark	99	DU-9098				KN-153	
904	Monster 900 Dark	01	DU-9098				KN-153	
904	Monster 900 i.e.	00	DU-9098				KN-153	
904	Monster 900 i.e.	02	DU-9098				KN-153	
904	Monster 900 Metallic	00-01	DU-9098				KN-153	
904	Monster 900s	98	DU-0900				KN-153	
904	Monster 900s	01	DU-9098				KN-153	
906	906 Paso	88-91					KN-153	
907	907 i.e.	90-93					KN-153	
916	Monster S4	01-03	DU-9001				KN-153	
916	Monster S4 Fogarty	02	DU-9001				KN-153	
916	Monster S4R	03-04	DU-9001				KN-153	
916	ST4	99-00	DU-9098				KN-153	

2) Requires Two; 3) Requires Three; 4) Requires Four. The use of custom air filter requires removal of air box. Some custom filters and intakes are not legal for sale or use on any pollution controlled motor vehicle in California or states adopting California emission procedures. See knfilters.com for CARB status on each part for a specific vehicle.



# Motorcycle - Application Listing

CC	Model	Year	Air Filter	Air Filter Precharger	Custom	Custom Precharger	Oil Filter	Comments
<b>DUCATI</b>								
944	ST2	97-03	DU-9098				KN-153	
959	959 Panigale	16	DU-1112					
959	959 Panigale	16	DU-1112R*					*Race Specific
968	Desmosedici RR	08					KN-153	
992	GT1000	07-10	DU-1006				KN-153	
992	GT1000 Touring	09-10	DU-1006				KN-153	
992	Monster S2R 1000	06-08	DU-9001				KN-153	
992	Paul Smart 1000 LE	06	DU-1006				KN-153	
992	Sport 1000	06	DU-1006				KN-153	
992	Sport 1000 Biposto	07-08	DU-1006				KN-153	
992	Sport 1000 Monoposto	07	DU-1006				KN-153	
992	Sport 1000S	07-10	DU-1006				KN-153	
992	ST3	04-07	DU-9098				KN-153	
992	ST3S ABS	06-07	DU-9098				KN-153	
992	ST4	01-03	DU-9098				KN-153	
992	ST4s	01-05	DU-9098				KN-153	
992	ST4S ABS	03-05	DU-9098				KN-153	
996	996	98					KN-153	
996	996 Biposto	99-01					KN-153	
996	996 Monoposto	99-01					KN-153	
996	996 SPS	99-00					KN-153	
996	996 SPS Fogarty	99					KN-153	
996	996R	01					KN-153	
996	996S	00-01					KN-153	
996	996S Monoposto	01					KN-153	
996	Monster S4R	05-06	DU-9001				KN-153	
996	Monster S4Rs	06	DU-9001				KN-153	
997	Monster S4R	07	DU-9001				KN-153	
997	Monster S4R Testastretta	07-08	DU-9001				KN-153	
997	Monster S4Rs Testastretta	06-08	DU-9001				KN-153	
998	998 Biposto	02-03					KN-153	
998	998 Matrix	04					KN-153	
998	998 Monoposto	02-03					KN-153	
998	998R	02					KN-153	
998	998S	02					KN-153	
998	998S Bayliss	02					KN-153	
998	998S Bostrom	02					KN-153	
998	998S Monoposto	02					KN-153	
999	999	03-06					KN-153	
999	999R	03-06					KN-153	
999	999R FILA	03-04					KN-153	
999	999R Xerox	06					KN-153	
999	999S	03-06					KN-153	
999	Multistrada 1000 DS	05-06	DU-1004				KN-153	
999	Multistrada 1000s DS	05-06	DU-1004				KN-153	
1000	1000SS	03-06	DU-9098				KN-153	
1000	Monster 1000	04-05	DU-9001				KN-153	
1000	Monster 1000 Dark	03	DU-9001				KN-153	
1000	Monster 1000s	03-05	DU-9001				KN-153	
1000	Multistrada 1000 DS	03-04	DU-1004				KN-153	
1078	Multistrada 1100	07-09	DU-1004				KN-153	
1078	Multistrada 1100s	07-09	DU-1004				KN-153	
1079	Hypermotard 1100	08-09	DU-1006				KN-153	
1079	Hypermotard 1100s	08-09	DU-1006				KN-153	
1098	1098	07-08	DU-1007				KN-153	
1098	1098	07-08	DU-1007R*				KN-153	*Race Specific
1098	1098s	07-08	DU-1007				KN-153	

2) Requires Two; 3) Requires Three; 4) Requires Four. The use of custom air filter requires removal of air box. Some custom filters and intakes are not legal for sale or use on any pollution controlled motor vehicle in California or states adopting California emission procedures. See knfilters.com for CARB status on each part for a specific vehicle.

# Motorcycle - Application Listing

CC	Model	Year	Air Filter	Air Filter Precharger	Custom	Custom Precharger	Oil Filter	Comments
<b>DUCATI</b>								
1098	1098s	07-08	DU-1007R*				KN-153	*Race Specific
1099	Streetfighter	11	DU-1007				KN-153	
1099	Streetfighter	11	DU-1007R*				KN-153	*Race Specific
1099	Streetfighter S	11-13	DU-1007				KN-153	
1099	Streetfighter S	11-13	DU-1007R*				KN-153	*Race Specific
1100	Hypermotard 1100 EVO	10-13	DU-1006				KN-153	
1100	Monster 1100	08					KN-153	
1100	Monster 1100	09-11	DU-6908				KN-153	
1100	Monster 1100 EVO	12-13	DU-6908				KN-153	
1100	Monster 1100s	08					KN-153	
1100	Monster 1100s	09-11	DU-6908				KN-153	
1100	Monster Diesel	12					KN-153	
1100	Monster Diesel	13	DU-6908				KN-153	
1100	Streetfighter	09-10	DU-1007				KN-153	
1100	Streetfighter	09-10	DU-1007R*				KN-153	*Race Specific
1100	Streetfighter S	09-10	DU-1007				KN-153	
1100	Streetfighter S	09-10	DU-1007R*				KN-153	*Race Specific
1198	1098R	08-09	DU-1007					
1198	1098R	08-09	DU-1007R*					*Race Specific
1198	1198	09-11	DU-1007				KN-153	
1198	1198	09-11	DU-1007R*				KN-153	*Race Specific
1198	1198 Panigale R	16	DU-1112					
1198	1198 Panigale R	16	DU-1112R*					*Race Specific
1198	1198R Corse	10-11	DU-1007				KN-153	
1198	1198R Corse	10-11	DU-1007R*				KN-153	*Race Specific
1198	1198S	09-11	DU-1007				KN-153	
1198	1198S	09-11	DU-1007R*				KN-153	*Race Specific
1198	1198S Corse	10	DU-1007				KN-153	
1198	1198S Corse	10	DU-1007R*				KN-153	*Race Specific
1198	1198SP	11	DU-1007				KN-153	
1198	1198SP	11	DU-1007R*				KN-153	*Race Specific
1198	1199 Panigale	12-14	DU-1112				KN-159	
1198	1199 Panigale	12-14	DU-1112R*				KN-159	*Race Specific
1198	1199 Panigale R	13-14	DU-1112				KN-159	
1198	1199 Panigale R	13-14	DU-1112R*				KN-159	*Race Specific
1198	1199 Panigale R	15	DU-1112					
1198	1199 Panigale R	15	DU-1112R*					*Race Specific
1198	1199 Panigale S	12-14	DU-1112				KN-159	
1198	1199 Panigale S	12-14	DU-1112R*				KN-159	*Race Specific
1198	Diavel	11-16	DU-1007				KN-153	
1198	Diavel	11-16	DU-1007R*				KN-153	*Race Specific
1198	Diavel Carbon	11-16	DU-1007				KN-153	
1198	Diavel Carbon	11-16	DU-1007R*				KN-153	*Race Specific
1198	Diavel Cromo	12	DU-1007				KN-153	
1198	Diavel Cromo	12	DU-1007R*				KN-153	*Race Specific
1198	Diavel Dark	13-14	DU-1007				KN-153	
1198	Diavel Dark	13-14	DU-1007R*				KN-153	*Race Specific
1198	Diavel Strada	13-14	DU-1007				KN-153	
1198	Diavel Strada	13-14	DU-1007R*				KN-153	*Race Specific
1198	Diavel Titanium	15	DU-1007				KN-153	
1198	Diavel Titanium	15	DU-1007R*				KN-153	*Race Specific
1198	Monster 1200	14-16	DU-1006				KN-153	
1198	Monster 1200 R	16	DU-1006					
1198	Monster 1200s	14-16	DU-1006				KN-153	
1198	Monster 1200s Stripe	15	DU-1006				KN-153	
1198	Multistrada 1200	10	DU-1210				KN-153	
1198	Multistrada 1200	11	DU-1007*				KN-153	*Non-US, Exc. ABS

2) Requires Two; 3) Requires Three; 4) Requires Four. The use of custom air filter requires removal of air box. Some custom filters and intakes are not legal for sale or use on any pollution controlled motor vehicle in California or states adopting California emission procedures. See knfilters.com for CARB status on each part for a specific vehicle.

# Motorcycle - Application Listing

CC	Model	Year	Air Filter	Air Filter Precharger	Custom	Custom Precharger	Oil Filter	Comments
<b>DUCATI</b>								
1198	Multistrada 1200	11	DU-1007R*				KN-153	*Non-US, Exc. ABS, Race Specific
1198	Multistrada 1200	11	DU-1210*				KN-153	*US
1198	Multistrada 1200	12-14	DU-1210				KN-153	
1198	Multistrada 1200	15-16	DU-1112				KN-153	
1198	Multistrada 1200	15-16	DU-1112R*				KN-153	*Race Specific
1198	Multistrada 1200s	11	DU-1210				KN-153	
1198	Multistrada 1200s	15-16	DU-1112				KN-153	
1198	Multistrada 1200s	15-16	DU-1112R*				KN-153	*Race Specific
1198	Multistrada 1200s Granturismo	13-14	DU-1210				KN-153	
1198	Multistrada 1200s Pikes Peak	12-14	DU-1210				KN-153	
1198	Multistrada 1200s Pikes Peak	16	DU-1112				KN-153	
1198	Multistrada 1200s Pikes Peak	16	DU-1112R*				KN-153	*Race Specific
1198	Multistrada 1200s Sport	10	DU-1210				KN-153	
1198	Multistrada 1200s Sport	12-14	DU-1210				KN-153	
1198	Multistrada 1200s Touring	10	DU-1210				KN-153	
1198	Multistrada 1200s Touring	12-14	DU-1210				KN-153	
1198	Panigale R	15					KN-159	
1200	Multistrada 1200s	10	DU-1210				KN-153	
1285	1200 Panigale	15					KN-159	
1285	1200 Panigale S	15					KN-159	
1285	1299 Panigale	15	DU-1112					
1285	1299 Panigale	15	DU-1112R*					*Race Specific
1285	1299 Panigale	16	DU-1112				KN-159	
1285	1299 Panigale	16	DU-1112R*				KN-159	*Race Specific
1285	1299 Panigale R	15-16	DU-1112					
1285	1299 Panigale R	15-16	DU-1112R*					*Race Specific
1285	1299 Panigale S	15	DU-1112					
1285	1299 Panigale S	15	DU-1112R*					*Race Specific
1285	1299 Panigale S	16	DU-1112				KN-159	
1285	1299 Panigale S	16	DU-1112R*				KN-159	*Race Specific
<b>HONDA</b>								
49	CB50R Dream 50	04					KN-566	
50	Z50R	79-99			R-1040	22-8008PK		
50	Z50RD	86			R-1040	22-8008PK		
80	CR80R	86-89	HA-8086					
80	CRF80F	04-09	HA-1088	22-8008PK				
80	CRF80F	11-13	HA-1088	22-8008PK				
80	XR80R	85-03	HA-1088	22-8008PK				
82	CR80R	90-02	HA-8086					
85	CR85R	03-04	HA-8086					
85	CR85R Expert	03-04	HA-8086					
86	CR85R	05-07	HA-8086					
86	CR85R Expert	05-07	HA-8086					
100	CRF100F	04-09	HA-1088	22-8008PK				
100	CRF100F	11-13	HA-1088	22-8008PK				
100	XR100R	85-03	HA-1088	22-8008PK				
110	NHX110	10	HA-1010					
121	VT125C Shadow	05-08					KN-113	
125	CBR125R	03-15	HA-1502					
125	CR125R	90-01	HA-2591	HA-2591DK				
125	Grom 125	14-15	HA-1313					
125	MSX125	13-15	HA-1313					
125	NES125	00-06	HA-1510					
125	PCX125	10-12	HA-1211					
125	PCX125	13-14	HA-1213					
125	PES125	06-10	HA-1510					

2) Requires Two; 3) Requires Three; 4) Requires Four. The use of custom air filter requires removal of air box. Some custom filters and intakes are not legal for sale or use on any pollution controlled motor vehicle in California or states adopting California emission procedures. See knfilters.com for CARB status on each part for a specific vehicle.

# Motorcycle - Application Listing

CC	Model	Year	Air Filter	Air Filter Precharger	Custom	Custom Precharger	Oil Filter	Comments
<b>HONDA</b>								
125	SES125	02-04	HA-1510					
125	VT125C Shadow	99-04					KN-113	
125	XL125V Varadero	01-10					KN-113	
125	XL125V Varadero De Luxe	11					KN-113	
150	CBR150R	02	HA-1502					
150	CRF150F	03-09	HA-1503					
150	CRF150F	12-14	HA-1503				KN-116	
150	CRF150F	15-16	HA-1503					
150	CRF150R	07-14	HA-1507				KN-116	
150	CRF150R	15	HA-1507					
150	CRF150R	16	HA-1507				KN-116	
150	CRF150R Expert	07-14	HA-1507				KN-116	
150	CRF150R Expert	15	HA-1507					
150	NES150	00-06	HA-1510					
150	NSR150	98-01	HA-1598					
150	PES150	06-10	HA-1510					
150	PS150i	11-12	HA-1510					
150	SES150	02-04	HA-1510					
200	XR200R	84-02	HA-2584	HA-1315PR				
230	CRF230F	03-09	HA-1503					
230	CRF230F	12-16	HA-1503					
234	CMX250C Rebel	96-97	HA-2596					
234	CMX250C Rebel	99-09	HA-2596					
234	CMX250C Rebel	12-16	HA-2596					
249	CBR250R	11-13	HA-2511				KN-112	
249	CBR250R ABS	13	HA-2511				KN-112	
249	CRF250X	12-16	HA-2505XD				KN-116	
250	CBF250	04-06					KN-113	
250	CBX250 RSE	83-00					KN-112	
250	CR250R	91-01	HA-2591	HA-2591DK				
250	CRF250L	13-15	HA-2513				KN-112	
250	CRF250R	04-09	HA-4503XD	HA-4503DK			KN-116	
250	CRF250R	10-13	HA-4509XD				KN-116	
250	CRF250R	14-16	HA-4513XD				KN-116	
250	CRF250X	04-09	HA-2505XD				KN-116	
250	NX250	88-95					KN-112	
250	TLR250	85-87					KN-112	
250	VT250	83-87					KN-111	
250	VTR250 Interceptor	88-90					KN-111	
250	XL250	88-91					KN-112	
250	XL250 R Baja	91					KN-112	
250	XL250R	84-87					KN-112	
250	XR250 Super	97-04					KN-112	
250	XR250L	91-99	HA-1312	HA-1312PR			KN-112	
250	XR250R	86-04	HA-1312	HA-1312PR			KN-112	
286	CB300F	15-16	HA-2511				KN-112	
286	CBR300R	15-16	HA-2511				KN-112	
286	CBR300R ABS	15	HA-2511				KN-112	
350	CB350S	86-89					KN-111	
350	XL350R	84-87					KN-112	
350	XR350R	86-87					KN-112	
397	XR400R	04	HA-1314	HA-1315PR			KN-112	
399	VFR400R - NC30	90-92					KN-303*	*Chrome=KN-303C
400	CB400 VTEC	98	HA-4098				KN-113	
400	CB400 VTEC	99-00	HA-4098					
400	CB400F	90					KN-303*	*Chrome=KN-303C
400	CB400F CB-1	89-92					KN-303*	*Chrome=KN-303C

2) Requires Two; 3) Requires Three; 4) Requires Four. The use of custom air filter requires removal of air box. Some custom filters and intakes are not legal for sale or use on any pollution controlled motor vehicle in California or states adopting California emission procedures. See knfilters.com for CARB status on each part for a specific vehicle.

# Motorcycle - Application Listing

CC	Model	Year	Air Filter	Air Filter Precharger	Custom	Custom Precharger	Oil Filter	Comments
<b>HONDA</b>								
400	CB400RR - NC29	91-93	HA-0004				KN-303*	*Chrome=KN-303C
400	CB400SF	00	HA-4020					
400	CBX400 F	83-86					KN-111	
400	FJS400	09-11					KN-204*	*Chrome=KN-204C
400	NT400 Bros	88-92					KN-303*	*Chrome=KN-303C
400	RVF400	99					KN-303*	*Chrome=KN-303C
400	VF400FD	83-86					KN-202	
400	VFR400 Pro-Arm	87-89					KN-303*	*Chrome=KN-303C
400	VFR400R	87					KN-303*	*Chrome=KN-303C
400	VFR400R - NC30	93					KN-303*	*Chrome=KN-303C
400	XR400R	96-03	HA-1314	HA-1315PR			KN-112	
440	XR440 R/SM	96-04					KN-112	
444	CRF450R	02	HA-4502				KN-116	
444	CRF450R	03-08	HA-4503XD	HA-4503DK			KN-116	
444	CRF450R	09-12	HA-4509XD				KN-116	
444	CRF450X	05-09	HA-2505XD				KN-116	
449	CRF450R	13-16	HA-4513XD				KN-116	
449	CRF450X	12-16	HA-2505XD				KN-116	
450	CB450DXK	89-92					KN-111	
450	CB450SC	86					KN-111	
450	CB450SG	86-88					KN-111	
450	CMX450C Rebel	86-87					KN-111	
471	CB500F	13-15	HA-5013				KN-204*	*Chrome=KN-204C
471	CB500F	16	HA-5013					
471	CB500F ABS	13-15	HA-5013				KN-204*	*Chrome=KN-204C
471	CB500X	13-15	HA-5013				KN-204*	*Chrome=KN-204C
471	CB500X	16	HA-5013					
471	CB500X ABS	13-15	HA-5013				KN-204*	*Chrome=KN-204C
471	CBR500R	13-15	HA-5013				KN-204*	*Chrome=KN-204C
471	CBR500R	16	HA-5013					
471	CBR500R ABS	13-15	HA-5013				KN-204*	*Chrome=KN-204C
499	GB500	90					KN-112	
500	CB500 Cup	99					KN-303*	*Chrome=KN-303C
500	CBF500	04-06	HA-6098				KN-303*	*Chrome=KN-303C
500	CBF500	07-08					KN-303*	*Chrome=KN-303C
500	CBF500 ABS	04-08					KN-303*	*Chrome=KN-303C
500	CR500R	89-01	HA-2591	HA-2591DK				
500	GB500	89					KN-112	
500	VF500F Interceptor	84-86	HA-3084				KN-202	
500	VF500F Interceptor	87					KN-202	
500	VT500 EF Eurosport	86-88					KN-202	
500	VT500C Shadow	83-86	HA-5083				KN-202	
500	VT500C Shadow	87-88					KN-202	
500	VT500FT Ascot	85-88					KN-202	
500	XBR500	85-88					KN-112	
502	CB500	94-99	HA-5094				KN-303*	*Chrome=KN-303C
502	CB500	00-02					KN-303*	*Chrome=KN-303C
550	CBX550	81-86					KN-111	
583	XL600V Transalp	90-99	HA-6089				KN-303*	*Chrome=KN-303C
583	XL600V Transalp	00					KN-303*	*Chrome=KN-303C
599	599	04	HA-6098				KN-204*	*Chrome=KN-204C
599	599	06	HA-6098				KN-204*	*Chrome=KN-204C
599	CB600F	07	HA-5907				KN-204*	*Chrome=KN-204C
599	CB600F Hornet	08-13	HA-5907				KN-204*	*Chrome=KN-204C
599	CBF600	04-06	HA-6098				KN-204*	*Chrome=KN-204C
599	CBF600	07-13	HA-5907				KN-204*	*Chrome=KN-204C
599	CBF600S	04-06	HA-6098				KN-204*	*Chrome=KN-204C

2) Requires Two; 3) Requires Three; 4) Requires Four. The use of custom air filter requires removal of air box. Some custom filters and intakes are not legal for sale or use on any pollution controlled motor vehicle in California or states adopting California emission procedures. See knfilters.com for CARB status on each part for a specific vehicle.

# Motorcycle - Application Listing

CC	Model	Year	Air Filter	Air Filter Precharger	Custom	Custom Precharger	Oil Filter	Comments
<b>HONDA</b>								
599	CBF600S	07-11	HA-5907				KN-204*	*Chrome=KN-204C
599	CBR600F	11-12	HA-5907				KN-204*	*Chrome=KN-204C
599	CBR600RR	03-06	HA-6003				KN-204*	*Chrome=KN-204C
599	CBR600RR	07-16	HA-6007				KN-204*	*Chrome=KN-204C
599	CBR600RR	07-16	HA-6007R*				KN-204**	*Race Specific/ **Chrome=KN-204C
599	CBR600RR ABS	09-10	HA-6007				KN-204*	*Chrome=KN-204C
599	CBR600RR ABS	09-10	HA-6007R*				KN-204**	*Race Specific/ **Chrome=KN-204C
599	CBR600RR ABS	14-15	HA-6007				KN-204*	*Chrome=KN-204C
599	CBR600RR ABS	14-15	HA-6007R*				KN-204**	*Race Specific/ **Chrome=KN-204C
600	CB600 Hornet	98-03	HA-6098				KN-303*	*Chrome=KN-303C
600	CB600 Hornet	04-06	HA-6098				KN-204*	*Chrome=KN-204C
600	CB600 Hornet	08-11					KN-204*	*Chrome=KN-204C
600	CB600F	04-06					KN-204*	*Chrome=KN-204C
600	CB600F Hornet	03-06					KN-204*	*Chrome=KN-204C
600	CB600S Hornet	00-02					KN-303*	*Chrome=KN-303C
600	CB600S Hornet	03					KN-204*	*Chrome=KN-204C
600	CBF600F	05	HA-6098					
600	CBR600 Hurricane	91-94					KN-303*	*Chrome=KN-303C
600	CBR600 RA	09-10	HA-6007				KN-204*	*Chrome=KN-204C
600	CBR600 RA	09-10	HA-6007R*				KN-204**	*Race Specific/ **Chrome=KN-204C
600	CBR600 Sport	01-02					KN-204*	*Chrome=KN-204C
600	CBR600F	90	HA-6087				KN-303*	*Chrome=KN-303C
600	CBR600F	01-06	HA-6001				KN-204*	*Chrome=KN-204C
600	CBR600F	07					KN-204*	*Chrome=KN-204C
600	CBR600F Hurricane	87-89	HA-6087				KN-303*	*Chrome=KN-303C
600	CBR600F2	91-94	HA-6091				KN-303*	*Chrome=KN-303C
600	CBR600F3	95-98	HA-6095				KN-303*	*Chrome=KN-303C
600	CBR600F4	99-00	HA-6099				KN-303*	*Chrome=KN-303C
600	CBR600F4i	01-06	HA-6001				KN-204*	*Chrome=KN-204C
600	NTV600	88-92					KN-303*	*Chrome=KN-303C
600	VT600C Shadow VLX	88-98	HA-6088				KN-303*	*Chrome=KN-303C
600	VT600C Shadow VLX	99-07	HA-6199				KN-303*	*Chrome=KN-303C
600	VT600CD Shadow VLX Deluxe	93-98	HA-6088				KN-303*	*Chrome=KN-303C
600	VT600CD Shadow VLX Deluxe	99-07	HA-6199				KN-303*	*Chrome=KN-303C
600	XL600L	83-87					KN-112	
600	XL600R	83-88					KN-112	
600	XL600V Transalp	87-88					KN-303*	*Chrome=KN-303C
600	XL600V Transalp	89	HA-6089				KN-303*	*Chrome=KN-303C
600	XR600R	85-00	HA-1315	HA-1315PR			KN-112	
600	XR600R	01-02					KN-112	
647	NT650V Deauville	98-04					KN-303*	*Chrome=KN-303C
647	NTV650	90-91					KN-303*	*Chrome=KN-303C
647	NTV650 Revere	93-97					KN-303*	*Chrome=KN-303C
649	CB650F	14					KN-204*	*Chrome=KN-204C
649	CBR650F	14-15	HA-6414				KN-204*	*Chrome=KN-204C
649	CBR650F	16	HA-6414					
649	CBR650F ABS	14-15	HA-6414				KN-204*	*Chrome=KN-204C
650	CB650 F2	91					KN-303*	*Chrome=KN-303C
650	CX650 ED Eurosport	83-86					KN-111	
650	CX650T Turbo	83-86					KN-111	
650	FMX650	05-06	HA-6505				KN-112	
650	FMX650	07					KN-112	
650	FX650 Vigor	99-02					KN-112	
650	NT650 Bros	88-92					KN-303*	*Chrome=KN-303C

2) Requires Two; 3) Requires Three; 4) Requires Four. The use of custom air filter requires removal of air box. Some custom filters and intakes are not legal for sale or use on any pollution controlled motor vehicle in California or states adopting California emission procedures. See knfilters.com for CARB status on each part for a specific vehicle.

# Motorcycle - Application Listing

CC	Model	Year	Air Filter	Air Filter Precharger	Custom	Custom Precharger	Oil Filter	Comments
<b>HONDA</b>								
650	NT650 Hawk GT	88-92					KN-303*	*Chrome=KN-303C
650	NT650V Deauville	05					KN-303*	*Chrome=KN-303C
650	NTV650	88-89					KN-303*	*Chrome=KN-303C
650	NX650 Dominator	88-00	HA-0001				KN-112	
650	NX650 Dominator	01-02					KN-112	
650	SLR650	97-00					KN-112	
650	XL650V Transalp	00-06	HA-6501				KN-303*	*Chrome=KN-303C
650	XL650V Transalp	07	HA-6501				KN-204*	*Chrome=KN-204C
650	XR650L	93-09	HA-6592	HA-6592PR			KN-112	
650	XR650L	11					KN-112	
650	XR650L	12-16	HA-6592	HA-6592PR			KN-112	
650	XR650R	00-07	HA-6500				KN-112	
650	XRV650 Africa Twin	88-90					KN-303*	*Chrome=KN-303C;PD03
670	CTX700	14-15	HA-7012				KN-204*	*Chrome=KN-204C
670	CTX700 DCT ABS	14-15	HA-7012				KN-204*	*Chrome=KN-204C
670	CTX700N	14-15	HA-7012				KN-204*	*Chrome=KN-204C
670	CTX700N DCT ABS	14-15	HA-7012				KN-204*	*Chrome=KN-204C
670	NC700J NM4	15-16	HA-7012				KN-204*	*Chrome=KN-204C
670	NC700S	12-13	HA-7012				KN-204*	*Chrome=KN-204C
670	NC700X	12-15	HA-7012				KN-204*	*Chrome=KN-204C
670	NC700X DCT ABS	12-15	HA-7012				KN-204*	*Chrome=KN-204C
700	CB700SC Nighthawk S	84-86	HA-7084				KN-202	
700	NSA700 DN-01	08-09	HA-6708				KN-204*	*Chrome=KN-204C
700	NSA700 DN-01	10	HA-6708					
700	NT700V Deauville	06-11	HA-7010				KN-204*	*Chrome=KN-204C
700	NT700V Deauville	12					KN-204*	*Chrome=KN-204C
700	NT700VA	10-11	HA-7010				KN-204*	*Chrome=KN-204C
700	NT700VA	12					KN-204*	*Chrome=KN-204C
700	NT700VAA	10					KN-204*	*Chrome=KN-204C
700	NT700VAA	11	HA-7010				KN-204*	*Chrome=KN-204C
700	NT700VAA	12					KN-204*	*Chrome=KN-204C
700	VF700C Magna	84-86	HA-1210				KN-202	
700	VFR700 Interceptor	88					KN-202	
700	VFR700F Interceptor	86	HA-7587				KN-202	
700	VFR700F Interceptor	87					KN-202	
700	VFR700F2 Interceptor	86-87	HA-7587				KN-202	
700	VT700C Shadow	86-87					KN-202	
700	XL700V Transalp	08-10	HA-7008				KN-204*	*Chrome=KN-204C
700	XL700V Transalp	11-12					KN-204*	*Chrome=KN-204C
739	RVF750R - RC45	94-98					KN-303*	*Chrome=KN-303C
739	VF750C Magna	94-99	HA-7594				KN-303*	*Chrome=KN-303C
739	VFR750F Interceptor	90-97	HA-0003				KN-303*	*Chrome=KN-303C
739	VFR750F Interceptor	98					KN-303*	*Chrome=KN-303C
742	XRV750 Africa Twin	90-92	HA-6089				KN-303*	*Chrome=KN-303C
742	XRV750 Africa Twin	93-03	HA-0008				KN-303*	*Chrome=KN-303C
745	NC750	12-13					KN-204*	*Chrome=KN-204C
745	NC750	15					KN-204*	*Chrome=KN-204C
745	NC750S	14	HA-7012				KN-204*	*Chrome=KN-204C
745	NC750X	14	HA-7012				KN-204*	*Chrome=KN-204C
745	NC750X	15	HA-7012				KN-204*	*Chrome=KN-204C
745	VT750 C2B Shadow Phantom	12-13	HA-7504				KN-204*	*Chrome=KN-204C
745	VT750 RS Shadow	12-13	HA-7504				KN-204*	*Chrome=KN-204C
745	VT750C Shadow Aero	06	HA-7504				KN-204*	*Chrome=KN-204C
745	VT750C Shadow Aero	12-15	HA-7504				KN-204*	*Chrome=KN-204C
745	VT750C2 Shadow Spirit	13-14	HA-7504				KN-204*	*Chrome=KN-204C
745	VT750C2 Shadow Spirit ABS	13-14	HA-7504				KN-204*	*Chrome=KN-204C
745	VT750C2B Shadow Phantom	14-15	HA-7504				KN-204*	*Chrome=KN-204C

2) Requires Two; 3) Requires Three; 4) Requires Four. The use of custom air filter requires removal of air box. Some custom filters and intakes are not legal for sale or use on any pollution controlled motor vehicle in California or states adopting California emission procedures. See knfilters.com for CARB status on each part for a specific vehicle.

# Motorcycle - Application Listing

CC	Model	Year	Air Filter	Air Filter Precharger	Custom	Custom Precharger	Oil Filter	Comments
<b>HONDA</b>								
745	VT750CA Shadow Aero ABS	14-15	HA-7504				KN-204*	*Chrome=KN-204C
747	VF700C Magna	87	HA-7598				KN-202	
747	VF750C Magna	88	HA-7598				KN-202	
750	CB750 F2	92-00					KN-303*	*Chrome=KN-303C
750	CB750 Nighthawk	91-03	HA-7591				KN-303*	*Chrome=KN-303C
750	CB750 Seven Fifty	01-02					KN-303*	*Chrome=KN-303C
750	CBX750	84-86	HA-7591				KN-202	
750	RC30	88-91					KN-303*	*Chrome=KN-303C
750	VF750C Magna	87	HA-7598				KN-202	
750	VF750C Magna	89					KN-202	
750	VF750C Magna	93					KN-303*	*Chrome=KN-303C
750	VF750C Magna	00-03	HA-7594				KN-303*	*Chrome=KN-303C
750	VF750C2 Magna Deluxe	97-00	HA-7594				KN-303*	*Chrome=KN-303C
750	VF750CD Magna Deluxe	95-96	HA-7594				KN-303*	*Chrome=KN-303C
750	VFR750F Interceptor	86	HA-7587				KN-202	
750	VFR750F Interceptor	87					KN-202	
750	VFR750F Interceptor	88-89	HA-7587				KN-303*	*Chrome=KN-303C
750	VFR750R	00					KN-303*	*Chrome=KN-303C
750	VFR750R - RC30	90					KN-303*	*Chrome=KN-303C
750	VT750 C2 Shadow	01	HA-7500				KN-303*	*Chrome=KN-303C
750	VT750 C2 Shadow	12	HA-7504				KN-204*	*Chrome=KN-204C
750	VT750 C2B Shadow Phantom	10-11	HA-7504				KN-204*	*Chrome=KN-204C
750	VT750 RS Shadow	10-11	HA-7504				KN-204*	*Chrome=KN-204C
750	VT750C Shadow	97					KN-303*	*Chrome=KN-303C
750	VT750C Shadow	99-00					KN-303*	*Chrome=KN-303C
750	VT750C Shadow	01	HA-7500				KN-303*	*Chrome=KN-303C
750	VT750C Shadow	02					KN-303*	*Chrome=KN-303C
750	VT750C Shadow	08	HA-7504				KN-204*	*Chrome=KN-204C
750	VT750C Shadow	11	HA-7504				KN-204*	*Chrome=KN-204C
750	VT750C Shadow A.C.E.	98-00	HA-7500				KN-303*	*Chrome=KN-303C
750	VT750C Shadow Aero	04-05	HA-7504				KN-204*	*Chrome=KN-204C
750	VT750C Shadow Aero	07-09	HA-7504				KN-204*	*Chrome=KN-204C
750	VT750C2 Shadow Spirit	04					KN-204*	*Chrome=KN-204C
750	VT750C2 Shadow Spirit	05-09	HA-7504				KN-204*	*Chrome=KN-204C
750	VT750CD Shadow A.C.E. Deluxe	01-03	HA-7500				KN-303*	*Chrome=KN-303C
750	VT750CD Shadow Deluxe	98-00	HA-7500				KN-303*	*Chrome=KN-303C
750	VT750DC Shadow Spirit	01-03	HA-7500				KN-303*	*Chrome=KN-303C
750	VT750DC Shadow Spirit	04					KN-303*	*Chrome=KN-303C
750	VT750DC Shadow Spirit	05-07	HA-7500				KN-303*	*Chrome=KN-303C
782	VFR800 Crossrunner	11-12	HA-8098				KN-204*	*Chrome=KN-204C
782	VFR800 Interceptor	98-01	HA-8098				KN-303*	*Chrome=KN-303C
782	VFR800 Interceptor	02-09	HA-8098				KN-204*	*Chrome=KN-204C
782	VFR800 Interceptor	14-15	HA-8098				KN-204*	*Chrome=KN-204C
782	VFR800A Interceptor ABS	02-09	HA-8098				KN-204*	*Chrome=KN-204C
782	VFR800D Interceptor DLX	14-15	HA-8098				KN-204*	*Chrome=KN-204C
792	PC800 Pacific Coast	90	HA-8089				KN-303*	*Chrome=KN-303C
800	PC800 Pacific Coast	89	HA-8089				KN-303*	*Chrome=KN-303C
800	PC800 Pacific Coast	94-98	HA-8089				KN-303*	*Chrome=KN-303C
800	VT800C Shadow	88					KN-202	
896	CBR900RR	92					KN-303*	*Chrome=KN-303C
900	CBR900RR	93-99	HA-9092-A				KN-303*	*Chrome=KN-303C
900	CBR900RR Fireblade	00-01	HA-9200				KN-303*	*Chrome=KN-303C
900	CBR900RR Fireblade	02	HA-9502				KN-303*	*Chrome=KN-303C
900	CBR900RR Fireblade	03	HA-9502				KN-204*	*Chrome=KN-204C
919	919	02-07	HA-9002				KN-204*	*Chrome=KN-204C
919	CB900F	02-05	HA-9002				KN-204*	*Chrome=KN-204C
919	CB900F	06					KN-204*	*Chrome=KN-204C

2) Requires Two; 3) Requires Three; 4) Requires Four. The use of custom air filter requires removal of air box. Some custom filters and intakes are not legal for sale or use on any pollution controlled motor vehicle in California or states adopting California emission procedures. See knfilters.com for CARB status on each part for a specific vehicle.



# Motorcycle - Application Listing

CC	Model	Year	Air Filter	Air Filter Precharger	Custom	Custom Precharger	Oil Filter	Comments
<b>HONDA</b>								
919	CB900F	07	HA-9002				KN-204*	*Chrome=KN-204C
929	CBR929RR	00-01	HA-9200				KN-204*	*Chrome=KN-204C
954	CBR954RR	02-03	HA-9502				KN-204*	*Chrome=KN-204C
990	CBF1000	06-09	HA-1006				KN-204*	*Chrome=KN-204C
990	RC51	00-05	HA-5100				KN-204*	*Chrome=KN-204C
998	CB1000R	08-15	HA-1009				KN-204*	*Chrome=KN-204C
999	CBR1000RR	04-07	HA-1004				KN-204*	*Chrome=KN-204C
999	CBR1000RR	04-07	HA-1004R*				KN-204**	*Race Specific/ **Chrome=KN-204C
999	CBR1000RR	08-16	HA-1008				KN-204*	*Chrome=KN-204C
999	CBR1000RR	08-16	HA-1008R*				KN-204**	*Race Specific/ **Chrome=KN-204C
999	CBR1000RR ABS	12-15	HA-1008				KN-204*	*Chrome=KN-204C
999	CBR1000RR ABS	12-15	HA-1008R*				KN-204**	*Race Specific/ **Chrome=KN-204C
999	CBR1000RR SP	14	HA-1008				KN-204*	*Chrome=KN-204C
999	CBR1000RR SP	14	HA-1008R*				KN-204**	*Race Specific/ **Chrome=KN-204C
999	CBR1000RR SP Repsol Edition	15	HA-1008				KN-204*	*Chrome=KN-204C
999	CBR1000RR SP Repsol Edition	15	HA-1008R*				KN-204**	*Race Specific/ **Chrome=KN-204C
1000	CBF1000	10	HA-1006				KN-204*	*Chrome=KN-204C
1000	CBF1000	11					KN-204*	*Chrome=KN-204C
1000	CBF1000 F	06-09					KN-204*	*Chrome=KN-204C
1000	CBF1000 F	10-13	HA-1009				KN-204*	*Chrome=KN-204C
1000	CBF1000 F	14-15	HA-1009				KN-204*	*Chrome=KN-204C
1000	CBF1000 F Ltd. Ed.	09					KN-204*	*Chrome=KN-204C
1000	CBF1000 F Travel	07-09					KN-204*	*Chrome=KN-204C
1000	CBF1000 F Travel	10	HA-1009				KN-204*	*Chrome=KN-204C
1000	CBR1000F	89	HA-1087				KN-303*	*Chrome=KN-303C
1000	RC51	06	HA-5100				KN-204*	*Chrome=KN-204C
1000	VF1000F	85-86	HA-1250				KN-202	
1000	VF1000R	85-86	HA-1250				KN-202	
1000	VTR1000 Firestorm	97-03	HA-0011				KN-303*	*Chrome=KN-303C
1000	VTR1000 Firestorm	04-05	HA-0011				KN-204*	*Chrome=KN-204C
1000	VTR1000 SP-1	00	HA-5100				KN-303*	*Chrome=KN-303C
1000	VTR1000 SP-1	01-02	HA-5100				KN-204*	*Chrome=KN-204C
1000	VTR1000 SP-2	02-06	HA-5100				KN-204*	*Chrome=KN-204C
1000	VTR1000 Super Hawk	97-05	HA-0011				KN-204*	*Chrome=KN-204C
1000	XL1000 Varadero	99-02	HA-0011				KN-303*	*Chrome=KN-303C
1000	XL1000 Varadero	03-10	HA-1003				KN-204*	*Chrome=KN-204C
1000	XL1000 Varadero	11					KN-204*	*Chrome=KN-204C
1006	CB1000 Big One	93-97	HA-1013-1				KN-303*	*Chrome=KN-303C
1006	CBR1000F	90-97	HA-1087				KN-303*	*Chrome=KN-303C
1006	CBR1000F	98-99					KN-303*	*Chrome=KN-303C
1062	CBR1000F	87-88	HA-1087				KN-303*	*Chrome=KN-303C
1100	CB1100 SF X-Eleven	02-03					KN-303*	*Chrome=KN-303C
1100	CB1100SF	99-01	HA-1199				KN-303*	*Chrome=KN-303C
1100	CBR1100XX Super Blackbird	96-98	HA-1197				KN-303*	*Chrome=KN-303C
1100	CBR1100XX Super Blackbird	99-06	HA-1199				KN-303*	*Chrome=KN-303C
1100	ST1100	91-02	HA-1191				KN-303*	*Chrome=KN-303C
1100	ST1100	03					KN-303*	*Chrome=KN-303C
1100	ST1100 A	90-95					KN-303*	*Chrome=KN-303C
1100	ST1100 ABS II	92-97					KN-303*	*Chrome=KN-303C
1100	ST1100 ABS II	98-01	HA-1191				KN-303*	*Chrome=KN-303C
1100	VF1100C V65 Magna	86	HA-6583				KN-202	
1100	VT1100C Shadow	85-86					KN-202	
1100	VT1100C Shadow	87-88	HA-1187				KN-202	
1100	VT1100C Shadow	89-98	HA-1187				KN-303*	*Chrome=KN-303C

2) Requires Two; 3) Requires Three; 4) Requires Four. The use of custom air filter requires removal of air box. Some custom filters and intakes are not legal for sale or use on any pollution controlled motor vehicle in California or states adopting California emission procedures. See knfilters.com for CARB status on each part for a specific vehicle.

# Motorcycle - Application Listing

CC	Model	Year	Air Filter	Air Filter Precharger	Custom	Custom Precharger	Oil Filter	Comments
<b>HONDA</b>								
1100	VT1100C Shadow Spirit	97-07	HA-1187				KN-303*	*Chrome=KN-303C
1100	VT1100C2 Shadow A.C.E.	95-99	HA-1187				KN-303*	*Chrome=KN-303C
1100	VT1100C2 Shadow Sabre	99					KN-303*	*Chrome=KN-303C
1100	VT1100C2 Shadow Sabre	00-07	HA-1187				KN-303*	*Chrome=KN-303C
1100	VT1100C3 Shadow Aero	98-02	HA-1187				KN-303*	*Chrome=KN-303C
1100	VT1100CL Shadow	92-94	HA-1187				KN-303*	*Chrome=KN-303C
1100	VT1100D2 Shadow A.C.E.	99	HA-1187				KN-303*	*Chrome=KN-303C
1100	VT1100T Shadow A.C.E. Tourer	98-01	HA-1187				KN-303*	*Chrome=KN-303C
1100	VT1100T Shadow A.C.E. Tourer	02					KN-303*	*Chrome=KN-303C
1100	X-11	99	HA-1199				KN-303*	*Chrome=KN-303C
1137	X-11	00-01	HA-1199				KN-303*	*Chrome=KN-303C
1140	CB1100	13-14	HA-1301				KN-204*	*Chrome=KN-204C
1140	CB1100	15	HA-1301					
1140	CB1100 ABS	13-14	HA-1301				KN-204*	*Chrome=KN-204C
1140	CB1100 DLX	14	HA-1301				KN-204*	*Chrome=KN-204C
1200	GL1200	85-88					KN-401	
1200	GL1200 Gold Wing	85-87					KN-401	
1200	GL1200 Gold Wing	90					KN-401	
1200	GL1200 Gold Wing SE-i	86	HA-8085				KN-401	
1200	GL1200A Gold Wing Aspencade	84-87	HA-8084				KN-401	
1200	GL1200i Gold Wing Interstate	84-87	HA-8084				KN-401	
1235	VFR1200 Crosstourer	12-13	HA-1110				KN-204*	*Chrome=KN-204C
1235	VFR1200 Crosstourer	14-15	HA-1110					
1237	VFR1200	14	HA-1110					
1237	VFR1200	15	HA-1110				KN-204*	*Chrome=KN-204C
1237	VFR1200F	10-13	HA-1110				KN-204*	*Chrome=KN-204C
1261	CTX1300	14-15	HA-1302				KN-204*	*Chrome=KN-204C
1261	CTX1300 Deluxe	14	HA-1302				KN-204*	*Chrome=KN-204C
1261	ST1300	10-14	HA-1302				KN-204*	*Chrome=KN-204C
1261	ST1300	15	HA-1302					
1261	ST1300	16	HA-1302				KN-204*	*Chrome=KN-204C
1261	ST1300 ABS	10	HA-1302				KN-204*	*Chrome=KN-204C
1261	STX1300	15					KN-204*	*Chrome=KN-204C
1284	VTX1300 Retro	04	HA-1330				KN-204*	*Chrome=KN-204C
1284	VTX1300C	04-05	HA-1330				KN-204*	*Chrome=KN-204C
1284	VTX1300R	05	HA-1330				KN-204*	*Chrome=KN-204C
1284	VTX1300S	03-05	HA-1330				KN-204*	*Chrome=KN-204C
1300	CB1300	06-07	HA-1301				KN-204*	*Chrome=KN-204C
1300	CB1300	09	HA-1301					
1300	CB1300	10-12	HA-1301				KN-204*	*Chrome=KN-204C
1300	CB1300 Super Four	01-02	HA-1301					
1300	CB1300 Super Four	03-05	HA-1301				KN-204*	*Chrome=KN-204C
1300	CB1300F	03-08					KN-204*	*Chrome=KN-204C
1300	CB1300S	06					KN-204*	*Chrome=KN-204C
1300	CB1300S	07-12	HA-1301				KN-204*	*Chrome=KN-204C
1300	CB1300SA	08-10					KN-204*	*Chrome=KN-204C
1300	ST1300	02-09	HA-1302				KN-204*	*Chrome=KN-204C
1300	ST1300 Pan European	02-07	HA-1302				KN-204*	*Chrome=KN-204C
1300	ST1300 Pan European	08-09					KN-204*	*Chrome=KN-204C
1300	VTX1300C	06-09	HA-1330				KN-204*	*Chrome=KN-204C
1300	VTX1300R	06-09	HA-1330				KN-204*	*Chrome=KN-204C
1300	VTX1300S	06-07	HA-1330				KN-204*	*Chrome=KN-204C
1300	VTX1300T	08-09	HA-1330				KN-204*	*Chrome=KN-204C
1312	VT1300CR Staline	10-16	HA-1310				KN-204*	*Chrome=KN-204C
1312	VT1300CRA Staline ABS	14-15	HA-1310				KN-204*	*Chrome=KN-204C
1312	VT1300CS Sabre	10-14	HA-1310				KN-204*	*Chrome=KN-204C
1312	VT1300CS Sabre	15					KN-204*	*Chrome=KN-204C

2) Requires Two; 3) Requires Three; 4) Requires Four. The use of custom air filter requires removal of air box. Some custom filters and intakes are not legal for sale or use on any pollution controlled motor vehicle in California or states adopting California emission procedures. See knfilters.com for CARB status on each part for a specific vehicle.

# Motorcycle - Application Listing

CC	Model	Year	Air Filter	Air Filter Precharger	Custom	Custom Precharger	Oil Filter	Comments
<b>HONDA</b>								
1312	VT1300CSA Sabre ABS	14	HA-1310				KN-204*	*Chrome=KN-204C
1312	VT1300CT Interstate	10-15	HA-1310				KN-204*	*Chrome=KN-204C
1312	VT1300CTA Interstate ABS	14-15	HA-1310				KN-204*	*Chrome=KN-204C
1312	VT1300CX Fury	10-13	HA-1310				KN-204*	*Chrome=KN-204C
1312	VT1300CX Fury	15-16	HA-1310				KN-204*	*Chrome=KN-204C
1312	VT13CX Fury	14	HA-1310				KN-204*	*Chrome=KN-204C
1312	VT13CXA Fury ABS	14	HA-1310				KN-204*	*Chrome=KN-204C
1312	VT13CXA Fury ABS	15					KN-204*	*Chrome=KN-204C
1500	GL1500 Black Widow	01					KN-303*	*Chrome=KN-303C
1500	GL1500 Gold Wing	91-93					KN-303*	*Chrome=KN-303C
1500	GL1500C Valkyrie	03	HA-1596				KN-303*	*Chrome=KN-303C
1500	GL1500SE Gold Wing SE	01					KN-303*	*Chrome=KN-303C
1520	GL1500 Gold Wing	88-90	HA-8088				KN-303*	*Chrome=KN-303C
1520	GL1500 Valkyrie Interstate	99-01	HA-1596				KN-303*	*Chrome=KN-303C
1520	GL1500A Gold Wing Aspencade	91-00	HA-8088				KN-303*	*Chrome=KN-303C
1520	GL1500C Valkyrie	97-02	HA-1596				KN-303*	*Chrome=KN-303C
1520	GL1500CT Valkyrie Tourer	97-00	HA-1596				KN-303*	*Chrome=KN-303C
1520	GL1500i Gold Wing Interstate	91-96	HA-8088				KN-303*	*Chrome=KN-303C
1520	GL1500SE Gold Wing SE	90-00	HA-8088				KN-303*	*Chrome=KN-303C
1795	VTX1800 Retro	02-04	HA-1802				KN-204*	*Chrome=KN-204C
1795	VTX1800C	02-08	HA-1802		RK-3906*	E-3016DK	KN-204**	*Mirrored/ **Chrome=KN-204C
1795	VTX1800C	02-08	HA-1802		RK-3916*	E-3016DK	KN-204**	*Grooved/ **Chrome=KN-204C
1795	VTX1800C	02-08	HA-1802		RK-3926*	E-3016DK	KN-204**	*Flamed/ **Chrome=KN-204C
1795	VTX1800F	07-08	HA-1802		RK-3906*	E-3016DK	KN-204**	*Mirrored/ **Chrome=KN-204C
1795	VTX1800F	07-08	HA-1802		RK-3916*	E-3016DK	KN-204**	*Grooved/ **Chrome=KN-204C
1795	VTX1800F	07-08	HA-1802		RK-3926*	E-3016DK	KN-204**	*Flamed/ **Chrome=KN-204C
1795	VTX1800N	07-08	HA-1802		RK-3906*	E-3016DK	KN-204**	*Mirrored/ **Chrome=KN-204C
1795	VTX1800N	07-08	HA-1802		RK-3916*	E-3016DK	KN-204**	*Grooved/ **Chrome=KN-204C
1795	VTX1800N	07-08	HA-1802		RK-3926*	E-3016DK	KN-204**	*Flamed/ **Chrome=KN-204C
1795	VTX1800R	02-03	HA-1802				KN-204*	*Chrome=KN-204C
1795	VTX1800R	07	HA-1802		RK-3906*	E-3016DK	KN-204**	*Mirrored/ **Chrome=KN-204C
1795	VTX1800R	07	HA-1802		RK-3916*	E-3016DK	KN-204**	*Grooved/ **Chrome=KN-204C
1795	VTX1800R	07	HA-1802		RK-3926*	E-3016DK	KN-204**	*Flamed/ **Chrome=KN-204C
1795	VTX1800R	08					KN-204*	*Chrome=KN-204C
1795	VTX1800T	07-08	HA-1802		RK-3906*	E-3016DK	KN-204**	*Mirrored/ **Chrome=KN-204C
1795	VTX1800T	07-08	HA-1802		RK-3916*	E-3016DK	KN-204**	*Grooved/ **Chrome=KN-204C
1795	VTX1800T	07-08	HA-1802		RK-3926*	E-3016DK	KN-204**	*Flamed/ **Chrome=KN-204C
1800	GL1800 Gold Wing	01-05	HA-1801				KN-204*	*Chrome=KN-204C
1800	GL1800 Gold Wing Airbag	07-09	HA-1801				KN-204*	*Chrome=KN-204C
1800	GL1800A Gold Wing ABS	01-05	HA-1801				KN-204*	*Chrome=KN-204C
1800	GL1800HP Gold Wing AC	06	HA-1801				KN-204*	*Chrome=KN-204C
1800	GL1800HP Gold Wing AC	09	HA-1801				KN-204*	*Chrome=KN-204C
1800	GL1800HPN Gold Wing ACN	06-09	HA-1801				KN-204*	*Chrome=KN-204C
1800	GL1800HPNA Gold Wing ACN ABS	06-09	HA-1801				KN-204*	*Chrome=KN-204C
1800	GL1800P Gold Wing PA	06-08	HA-1801				KN-204*	*Chrome=KN-204C
1800	VTX1800F	05-06	HA-1802				KN-204*	*Chrome=KN-204C
1800	VTX1800N	04-06	HA-1802				KN-204*	*Chrome=KN-204C
1800	VTX1800R	04-06	HA-1802				KN-204*	*Chrome=KN-204C
1800	VTX1800S	02-06	HA-1802				KN-204*	*Chrome=KN-204C
1832	GL1800 Gold Wing Airbag	10	HA-1801				KN-204*	*Chrome=KN-204C
1832	GL1800 Gold Wing Airbag	12-16	HA-1801				KN-204*	*Chrome=KN-204C
1832	GL1800 Valkyrie	14-15	HA-1801				KN-204*	*Chrome=KN-204C
1832	GL1800 Valkyrie ABS	14	HA-1801				KN-204*	*Chrome=KN-204C
1832	GL1800A Gold Wing ABS	10	HA-1801				KN-204*	*Chrome=KN-204C
1832	GL1800A Gold Wing ABS	12	HA-1801				KN-204*	*Chrome=KN-204C
1832	GL1800B Gold Wing F6B	13-15	HA-1801				KN-204*	*Chrome=KN-204C
1832	GL1800B Gold Wing F6B Deluxe	13-15	HA-1801				KN-204*	*Chrome=KN-204C

2) Requires Two; 3) Requires Three; 4) Requires Four. The use of custom air filter requires removal of air box. Some custom filters and intakes are not legal for sale or use on any pollution controlled motor vehicle in California or states adopting California emission procedures. See knfilters.com for CARB status on each part for a specific vehicle.

# Motorcycle - Application Listing

CC	Model	Year	Air Filter	Air Filter Precharger	Custom	Custom Precharger	Oil Filter	Comments
<b>HONDA</b>								
1832	GL1800HP Gold Wing AC	10	HA-1801				KN-204*	*Chrome=KN-204C
1832	GL1800HP Gold Wing AC	12-15	HA-1801				KN-204*	*Chrome=KN-204C
1832	GL1800HPN Gold Wing ACN	10	HA-1801				KN-204*	*Chrome=KN-204C
1832	GL1800HPNA Gold Wing ACN ABS	10	HA-1801				KN-204*	*Chrome=KN-204C
1832	GL1800HPNA Gold Wing ACN ABS	12	HA-1801				KN-204*	*Chrome=KN-204C
1832	GL1800HPNM Gold Wing ACN XM	12-15	HA-1801				KN-204*	*Chrome=KN-204C
1832	GL1800HPNM Gold Wing ACN XM ABS	12-15	HA-1801				KN-204*	*Chrome=KN-204C
1832	NRX1800 Valkyrie Rune	04-05					KN-204*	*Chrome=KN-204C
<b>HUSQVARNA</b>								
85	TC85 17/14	14-16	KT-4511XD	KT-4511DK				
125	CR125	95-13	HU-1200					
125	SMS4	12					KN-140	
125	TC125	14-15	KT-4511XD	KT-4511DK				
125	TE125	12					KN-140	
125	TE125	15-16	KT-4511XD	KT-4511DK				
125	WR125	95-10	HU-1200					
125	WR125	12-13	HU-1200					
126	CR125	92-94	HU-1200					
126	WR125	92-94	HU-1200					
150	CR150	11	HU-1200					
249	TC250	14-16	KT-4511XD	KT-4511DK				
249	TE250	02					KN-154	
249	TE250	03-07	HU-1200				KN-154	
249	TE250	08-09	HU-1200				KN-563	
249	TE250	10-13	HU-1200				KN-116	
249	TE250	14-16	KT-4511XD	KT-4511DK				
250	CR250	93-03	HU-1200					
250	FC250	14-16					KN-652	
250	FE250	14-15					KN-652	
250	FE250	16	KT-4511XD	KT-4511DK			KN-652	
250	SM250R	07					KN-154	
250	TC250	02					KN-154	
250	TC250	03-07	HU-1200				KN-154	
250	TC250	08	HU-1200				KN-563	
250	TC250	09-12	HU-1200				KN-116	
250	TC250R	13	HU-1200				KN-116	
250	TXC250	08-09	HU-1200				KN-563	
250	TXC250	10-12	HU-1200				KN-116	
250	TXC250R	13	HU-1200				KN-116	
250	WR250	92-10	HU-1200					
250	WR250	12-13	HU-1200					
293	TE300	14-16	KT-4511XD	KT-4511DK				
300	WR300	09-10	HU-1200					
300	WR300	12-13	HU-1200					
310	TE310	09					KN-563	
310	TE310	10	HU-1200				KN-563	
310	TE310	11-12	HU-1200				KN-116	
310	TE310R	13	HU-1200				KN-116	
310	TXC310	12	HU-1200					
310	TXC310R	13	HU-1200				KN-116	
349	WR360	92-94	HU-1200					
350	FC350	15-16					KN-652	
350	FE350	14-15					KN-652	
350	FE350	16	KT-4511XD	KT-4511DK			KN-652	
360	WR360	95-03	HU-1200					
400	SM400R	04-05	HU-1200				KN-154	
410	TE410E	98-01					KN-154	

2) Requires Two; 3) Requires Three; 4) Requires Four. The use of custom air filter requires removal of air box. Some custom filters and intakes are not legal for sale or use on any pollution controlled motor vehicle in California or states adopting California emission procedures. See knfilters.com for CARB status on each part for a specific vehicle.

# Motorcycle - Application Listing

CC	Model	Year	Air Filter	Air Filter Precharger	Custom	Custom Precharger	Oil Filter	Comments
<b>HUSQVARNA</b>								
449	FE450	16	KT-4511XD	KT-4511DK			KN-655	
449	TC449	11-12					KN-611	
449	TE449	11-12					KN-611	
450	FC450	14-16					KN-655	
450	FS450	16					KN-652	
450	SM450R	03-07	HU-1200				KN-154	
450	SM450R	08-10	HU-1200				KN-563	
450	SM450RR	09					KN-563	
450	SMR450	10	HU-1200				KN-611	
450	TC450	02					KN-154	
450	TC450	03-07	HU-1200				KN-154	
450	TC450	08-10	HU-1200				KN-563	
450	TE450	02					KN-154	
450	TE450	03-07	HU-1200				KN-154	
450	TE450	08-10	HU-1200				KN-563	
450	TXC450	08-10	HU-1200				KN-563	
450	TXC450	11					KN-563	
510	FE501	14-16	KT-4511XD	KT-4511DK			KN-655	
510	SM510R	03-07	HU-1200				KN-154	
510	SM510R	08-09	HU-1200				KN-563	
510	SM510R	10					KN-563	
510	SMR510	10	HU-1200				KN-611	
510	TC510	86-87	HU-0600					
510	TC510	03-07	HU-1200				KN-154	
510	TC510	08-10	HU-1200				KN-563	
510	TCX510	08-11					KN-563	
510	TE510	86-87	HU-0600					
510	TE510	03-07	HU-1200				KN-154	
510	TE510	08-10	HU-1200				KN-563	
510	TXC510	08-10	HU-1200				KN-563	
510	TXC510	11					KN-563	
511	SMR511	11					KN-611	
511	TE511	11-12					KN-611	
530	SM530RR	09					KN-563	
610	SM610	98-99					KN-154	
610	SM610	06-08					KN-154	
610	SM610S	00-01					KN-154	
610	SM610S IE	06-08					KN-154	
610	TE610	06-08					KN-154	
610	TE610 IE	06-08					KN-154	
610	TE610E	98-01					KN-154	
610	TE610E LT	00					KN-154	
630	SM630 IE	10					KN-563	
630	SMR630	11					KN-563	
630	SMS630	11					KN-563	
630	TE630	11					KN-563	
690	701 Enduro	16					KN-155*	*Tall Filter
690	701 Enduro	16					KN-651*	*Short Filter
690	701 Supermoto	16					KN-155*	*Tall Filter
690	701 Supermoto	16					KN-651*	*Short Filter
898	Nuda 900	12	BM-8006				KN-160	
898	Nuda 900R	12	BM-8006				KN-160	
<b>KAWASAKI</b>								
60	KX60	85-03	KA-6085					
65	KX65	00-09	KA-8088	22-8088PK				
65	KX65	11-16	KA-8088	22-8088PK				
80	KX80	91-00	KA-8088	22-8088PK				

2) Requires Two; 3) Requires Three; 4) Requires Four. The use of custom air filter requires removal of air box. Some custom filters and intakes are not legal for sale or use on any pollution controlled motor vehicle in California or states adopting California emission procedures. See knfilters.com for CARB status on each part for a specific vehicle.

# Motorcycle - Application Listing

CC	Model	Year	Air Filter	Air Filter Precharger	Custom	Custom Precharger	Oil Filter	Comments
<b>KAWASAKI</b>								
80	KX80 Big Wheel	91-94	KA-8088	22-8088PK				
85	KX85	01-13	KA-8088	22-8088PK				
100	KX100	95-09	KA-8088	22-8088PK				
100	KX100	11-13	KA-8088	22-8088PK				
110	KLX110	02-16	KA-1102				KN-112	
110	KLX110L	14-16	KA-1102				KN-112	
110	KSR110	02					KN-112	
110	KSR110	03-08	KA-1102				KN-112	
110	KSR110	09-11					KN-112	
125	BN125 Eliminator	98-09					KN-112	
125	KLX125	03-06	KA-1203				KN-132	
125	KLX125	10-11					KN-112	
125	KLX125 D-Tracker	10-11					KN-112	
125	KLX125L	03-06	KA-1203				KN-132	
125	KX125	87-89	KA-1287					
125	KX125	97-05	KA-1297					
125	KX125	06-08	KA-1297*					*Non-US
140	KLX140	08-16	KA-1408				KN-112	
140	KLX140L	08-16	KA-1408				KN-112	
200	KDX200	89-06	KA-1287					
220	KDX220R	97-05	KA-1287					
246	KDX250	91-94	KA-1287					
249	EL250 Eliminator	90-95					KN-401	
249	KX250F	12-16	KA-2506XD				KN-207	
250	EL250 Eliminator	88-89	KA-7587				KN-401	
250	EL250 Eliminator	96-03					KN-401	
250	EL250 Eliminator LX	89-90	KA-7587				KN-401	
250	EL250 Eliminator LX	93-94	KA-7587				KN-401	
250	EL250 Eliminator LX	96	KA-7587				KN-401	
250	EL250 Eliminator LX	98	KA-7587				KN-401	
250	EL250 Eliminator SE	88-90	KA-7587				KN-401	
250	EL250 Eliminator SE	94	KA-7587				KN-401	
250	EL250 Eliminator SE	96	KA-7587				KN-401	
250	EX250R Ninja	86-01	KA-2586		RC-1822*	RC-1820DK <sup>2</sup>	KN-401	*Inc. 2 Filters
250	EX250R Ninja	02-07	KA-2586				KN-401	
250	EX250R Ninja	08-12	KA-2508				KN-401	
250	GPX250R	88					KN-401	
250	KL250 Super Sherpa	97-98					KN-112	
250	KL250 Super Sherpa	00-07					KN-112	
250	KL250 Super Sherpa	09-10					KN-112	
250	KLR250	85-05					KN-123	
250	KLX250	90-92					KN-112	
250	KLX250 D-Tracker	98-99	KA-1287				KN-112	
250	KLX250 D-Tracker	01-07	KA-1287				KN-112	
250	KLX250 D-Tracker X	08-09					KN-112	
250	KLX250R	91-93					KN-112	
250	KLX250R	94-96	KA-1287				KN-112	
250	KLX250R	97					KN-112	
250	KLX250S	06-07	KA-1287				KN-112	
250	KLX250S	09-10					KN-112	
250	KLX250S	12-14					KN-112	
250	KLX250SF	09-10					KN-112	
250	KX250	87-89	KA-1287					
250	KX250	97-05	KA-1297					
250	KX250	06-07	KA-1297				KN-207	
250	KX250	08	KA-1297*				KN-207	*Non-US
250	KX250F	04-05	KA-2504				KN-207	

2) Requires Two; 3) Requires Three; 4) Requires Four. The use of custom air filter requires removal of air box. Some custom filters and intakes are not legal for sale or use on any pollution controlled motor vehicle in California or states adopting California emission procedures. See knfilters.com for CARB status on each part for a specific vehicle.

# Motorcycle - Application Listing

CC	Model	Year	Air Filter	Air Filter Precharger	Custom	Custom Precharger	Oil Filter	Comments
<b>KAWASAKI</b>								
250	KX250F	06-11	KA-2506XD				KN-207	
250	VN250 Eliminator V	97-02					KN-303*	*Chrome=KN-303C
250	VN250 Eliminator V	04-06					KN-204*	*Chrome=KN-204C
250	VN250 Eliminator V	07					KN-303*	*Chrome=KN-303C
250	ZR250 Balius II	97-98					KN-204*	*Chrome=KN-204C
250	ZR250 Balius II	00-06					KN-204*	*Chrome=KN-204C
250	ZXR250	91-93					KN-303*	*Chrome=KN-303C
250	ZZR250	90-93					KN-401	
250	ZZR250	98-02					KN-401	
296	EX300 Ninja	13-16	KA-2508				KN-303*	*Chrome=KN-303C
296	EX300 Ninja ABS	13-15	KA-2508				KN-303*	*Chrome=KN-303C
296	EX300 Ninja ABS SE	14	KA-2508				KN-303*	*Chrome=KN-303C
296	EX300 Ninja SE	14-15	KA-2508				KN-303*	*Chrome=KN-303C
300	KLX300R	96-07	KA-1287				KN-112	
300	KLX300R	08					KN-112	
400	EX400	89-90					KN-202	
400	GPZ400R	85-86					KN-401	
400	GPZ400R	89	KA-0850				KN-401	
400	KLX400R	03	SU-4000	SU-4000PK			KN-139	
400	KLX400SR	03	SU-4000	SU-4000PK			KN-139	
400	VN400 Vulcan	95-98	KA-8095				KN-303*	*Chrome=KN-303C
400	W400	06-08					KN-303*	*Chrome=KN-303C
400	ZL400 Eliminator	94-95					KN-401	
400	ZR400 Zephyr	89-95	KA-0850				KN-401	
400	ZR400 Zephyr X	96-98	KA-0850				KN-401	
400	ZR400 Zephyr X	00-02	KA-0850				KN-401	
400	ZR400 Zephyr X	03-08					KN-401	
400	ZRX400	94-96					KN-303*	*Chrome=KN-303C
400	ZRX400	98-01					KN-303*	*Chrome=KN-303C
400	ZRX400	03-08					KN-303*	*Chrome=KN-303C
400	ZX4	87-90					KN-303*	*Chrome=KN-303C
400	ZXR400	90	KA-4010					
400	ZXR400L	91-99	KA-4091				KN-303*	*Chrome=KN-303C
400	ZXR400L	00-02					KN-303*	*Chrome=KN-303C
400	ZXR400R	89-90					KN-303*	*Chrome=KN-303C
400	ZXR400R	91-94	KA-4091				KN-303*	*Chrome=KN-303C
400	ZXR400R	99	KA-4091				KN-303*	*Chrome=KN-303C
400	ZZR400	93-99	KA-6093				KN-303*	*Chrome=KN-303C
400	ZZR400	00					KN-303*	*Chrome=KN-303C
400	ZZR400	01	KA-6093				KN-303*	*Chrome=KN-303C
400	ZZR400	03-06	KA-6093				KN-303*	*Chrome=KN-303C
449	KX450F	12-15	KA-2506XD				KN-112	
449	KX450F	16					KN-207	
450	EN450	85-90					KN-202	
450	KLX450R	08-14	KA-4408	KA-4408DK			KN-112	
450	KX450F	06-11	KA-2506XD				KN-112	
500	EN500 Vulcan	90-96	KA-5090				KN-303*	*Chrome=KN-303C
500	EN500 Vulcan LTD	96-02	KA-5096				KN-303*	*Chrome=KN-303C
500	EN500 Vulcan LTD	03-06	KA-5096				KN-204*	*Chrome=KN-204C
500	EN500 Vulcan LTD	07-09	KA-5096				KN-303*	*Chrome=KN-303C
500	ER5	96					KN-303*	*Chrome=KN-303C
500	ER5	97-05	KA-0018				KN-303*	*Chrome=KN-303C
500	ER5	06					KN-303*	*Chrome=KN-303C
500	ER500 Twister	99					KN-303*	*Chrome=KN-303C
500	EX500	87-89	KA-5087		RC-0982*	RC-1820DK <sup>2</sup>	KN-202	*Inc. 2 Filters
500	EX500	90-93	KA-5087		RC-0982*	RC-1820DK <sup>2</sup>	KN-303**	*Inc. 2 Filters/ **Chrome=KN-303C

2) Requires Two; 3) Requires Three; 4) Requires Four. The use of custom air filter requires removal of air box. Some custom filters and intakes are not legal for sale or use on any pollution controlled motor vehicle in California or states adopting California emission procedures. See knfilters.com for CARB status on each part for a specific vehicle.

# Motorcycle - Application Listing

CC	Model	Year	Air Filter	Air Filter Precharger	Custom	Custom Precharger	Oil Filter	Comments
<b>KAWASAKI</b>								
500	EX500 Ninja	94-96	KA-5087		RC-0982*	RC-1820DK <sup>2</sup>	KN-303**	*Inc. 2 Filters/ **Chrome=KN-303C
500	EX500R Ninja	97-02	KA-5087		RC-0982*	RC-1820DK <sup>2</sup>	KN-303**	*Inc. 2 Filters/ **Chrome=KN-303C
500	EX500R Ninja	03-04	KA-5087		RC-0982*	RC-1820DK <sup>2</sup>	KN-204**	*Inc. 2 Filters/ **Chrome=KN-204C
500	EX500R Ninja	05-06	KA-5087				KN-204*	*Chrome=KN-204C
500	EX500R Ninja	07-09	KA-5087				KN-303*	*Chrome=KN-303C
500	GPZ500S	87-89					KN-202	
500	GPZ500S	90-01					KN-303*	*Chrome=KN-303C
500	GPZ500S	02	KA-5087				KN-204*	*Chrome=KN-204C
500	GPZ500S	03					KN-204*	*Chrome=KN-204C
500	KLE500	91-07					KN-303*	*Chrome=KN-303C
500	KX500	87-04	KA-1287					
500	ZZR500	90-96					KN-303*	*Chrome=KN-303C
539	GT550	90-95					KN-401	
550	GT550	83-89					KN-401	
550	GT550	96-01					KN-401	
550	ZR550 Zephyr	90-99	KA-0850				KN-401	
550	ZR550 Zephyr	00					KN-401	
550	ZX550 GPZ	86	KA-0850		RC-2382*		KN-401	*Inc. 2 Filters
550	ZX550 GPZ	87-92					KN-401	
560	KLR600	90	KA-0009				KN-123	
560	KLR600	91-93	KA-0009					
588	ZX6R Ninja	01	KA-6098				KN-303*	*Chrome=KN-303C
588	ZX6R Ninja	02	KA-6098				KN-204*	*Chrome=KN-204C
599	ZX600 Ninja	88-89	KA-7587		RC-1824*	RC-1820DK <sup>4</sup>	KN-401	*Inc. 4 Filters
599	ZX600R Ninja	90-94	KA-7587		RC-1824*	RC-1820DK <sup>4</sup>	KN-401	*Inc. 4 Filters
599	ZX6R Ninja	10-12	KA-6009				KN-303*	*Chrome=KN-303C
599	ZX6R Ninja	10-12	KA-6009R*				KN-303**	*Race Specific/ **Chrome=KN-303C
600	GPX600R	88-00					KN-401	
600	GPZ600R	85-89					KN-401	
600	KL600	84-90					KN-123	
600	KLR600	84-87					KN-123	
600	KLR600	88-89	KA-0009				KN-123	
600	ZL600	86-87			RC-1824*	RC-1820DK <sup>4</sup>	KN-401	*Inc. 4 Filters
600	ZL600 Eliminator	95					KN-401	
600	ZL600 Eliminator	96-97			RC-1824*	RC-1820DK <sup>4</sup>	KN-401	*Inc. 4 Filters
600	ZL600 Eliminator	98					KN-401	
600	ZX6 Ninja	90-92					KN-303*	*Chrome=KN-303C
600	ZX6 Ninja	93-01	KA-6093*				KN-303**	*Exc. OE Filter w/hole/ **Chrome=KN-303C
600	ZX600R Ninja	95-97	KA-7587		RC-1824*	RC-1820DK <sup>4</sup>	KN-401	*Inc. 4 Filters
600	ZX6R Ninja	95-97	KA-6095				KN-303*	*Chrome=KN-303C
600	ZX6R Ninja	98-00	KA-6098				KN-303*	*Chrome=KN-303C
600	ZX6R Ninja	07-08	KA-6007				KN-303*	*Chrome=KN-303C
600	ZX6R Ninja	07-08	KA-6007R*				KN-303**	*Race Specific/ **Chrome=KN-303C
600	ZX6R Ninja	09	KA-6009				KN-303*	*Chrome=KN-303C
600	ZX6R Ninja	09	KA-6009R*				KN-303**	*Race Specific/ **Chrome=KN-303C
600	ZX6RR Ninja	03-04	KA-6003				KN-204*	*Chrome=KN-204C
600	ZX6RR Ninja	05-06	KA-6005				KN-204*	*Chrome=KN-204C
600	ZZR600	90-92					KN-303*	*Chrome=KN-303C
600	ZZR600	93-01	KA-6093*				KN-303**	*Exc. OE Filter w/hole/ **Chrome=KN-303C
600	ZZR600	02-04	KA-6093*				KN-204**	*Exc. OE Filter w/hole/ **Chrome=KN-204C
600	ZZR600	05-06	KA-6093*				KN-204**	*Non-US/ **Chrome=KN-204C

2) Requires Two; 3) Requires Three; 4) Requires Four. The use of custom air filter requires removal of air box. Some custom filters and intakes are not legal for sale or use on any pollution controlled motor vehicle in California or states adopting California emission procedures. See knfilters.com for CARB status on each part for a specific vehicle.



# Motorcycle - Application Listing

CC	Model	Year	Air Filter	Air Filter Precharger	Custom	Custom Precharger	Oil Filter	Comments
<b>KAWASAKI</b>								
600	ZZR600	05-06	KA-6098*				KN-204**	*US/ **Chrome=KN-204C
600	ZZR600	07-08	KA-6098*				KN-303**	*US/ **Chrome=KN-303C;US
636	ZX636 Ninja ZX-6R	15					KN-303*	*Chrome=KN-303C
636	ZX636 Ninja ZX-6R ABS	15					KN-303*	*Chrome=KN-303C
636	ZX6R Ninja	03-04	KA-6003				KN-303*	*Chrome=KN-303C
636	ZX6R Ninja	05	KA-6005				KN-303*	*Chrome=KN-303C
636	ZX6R Ninja	06	KA-6005				KN-204*	*Chrome=KN-204C
636	ZX6R Ninja	13-16	KA-6009				KN-303*	*Chrome=KN-303C
636	ZX6R Ninja	13-16	KA-6009R*				KN-303**	*Race Specific/ **Chrome=KN-303C
649	EN650 Vulcan S	15-16					KN-303*	*Chrome=KN-303C
649	EN650 Vulcan S ABS	15-16					KN-303*	*Chrome=KN-303C
649	ER6f	16	KA-6512					
649	ER6n	16	KA-6512					
649	EX650 Ninja	12-15	KA-6512				KN-303*	*Chrome=KN-303C
649	EX650 Ninja	16					KN-303*	*Chrome=KN-303C
649	EX650 Ninja ABS	13-15	KA-6512				KN-303*	*Chrome=KN-303C
649	EX650 Ninja ABS	16					KN-303*	*Chrome=KN-303C
649	EX650R Ninja	06					KN-204*	*Chrome=KN-204C
649	EX650R Ninja	07-11					KN-303*	*Chrome=KN-303C
650	ER6f	06					KN-204*	*Chrome=KN-204C
650	ER6f	07-09					KN-303*	*Chrome=KN-303C
650	ER6f	12-15	KA-6512					
650	ER6n	06					KN-204*	*Chrome=KN-204C
650	ER6n	07-11					KN-303*	*Chrome=KN-303C
650	ER6n	12-14	KA-6512				KN-303*	*Chrome=KN-303C
650	ER6n	15	KA-6512					
650	KL650 Tengai	89					KN-123	
650	KLE650 Versys	07-16					KN-303*	*Chrome=KN-303C
650	KLR650	87-15	KA-6589	KA-6589PL			KN-123	
650	KLR650	16					KN-123	
650	KLR650 New Edition	14	KA-6589	KA-6589PL			KN-123	
650	KLX650C	93-96	KA-6589	KA-6589PL			KN-123	
650	KLX650C	97					KN-123	
650	KLX650D	96	KA-1287				KN-123	
650	KLX650R	93-97	KA-1287				KN-123	
650	KLX650R	98-01					KN-123	
650	KR650 C1	93					KN-401	
652	KL650 Tengai	90-91	KA-6589	KA-6589PL			KN-123	
652	KL650 Tengai	92					KN-123	
652	ZX600 Ninja	85-87	KA-0850		RC-1824*	RC-1820DK <sup>4</sup>	KN-401	*Inc. 4 Filters
737	ZXR750	90	KA-7589				KN-303*	*Chrome=KN-303C
739	GT750	90-96					KN-401	
749	VN750 Vulcan	86-98	KA-7586				KN-202	
749	VN750 Vulcan	99-03	KA-7586				KN-303*	*Chrome=KN-303C
749	VN750 Vulcan	04-06	KA-7586				KN-204*	*Chrome=KN-204C
750	GPX750R	86					KN-401	
750	GPX750R	87-89	KA-7587		RC-2914*		KN-401	*Inc. 4 Filters
750	GPZ750	86-89					KN-401	
750	GPZ750R	85-88					KN-401	
750	GT750	82-89					KN-401	
750	Z750	84-87					KN-401	
750	Z750	04-06	KA-1003				KN-204*	*Chrome=KN-204C
750	Z750	07-12	KA-1003				KN-303*	*Chrome=KN-303C
750	Z750R	11-12	KA-1003				KN-303*	*Chrome=KN-303C
750	Z750S	05-06	KA-1003				KN-204*	*Chrome=KN-204C
750	Z750S	07	KA-1003				KN-303*	*Chrome=KN-303C
750	Z750S	09					KN-303*	*Chrome=KN-303C

2) Requires Two; 3) Requires Three; 4) Requires Four. The use of custom air filter requires removal of air box. Some custom filters and intakes are not legal for sale or use on any pollution controlled motor vehicle in California or states adopting California emission procedures. See knfilters.com for CARB status on each part for a specific vehicle.

# Motorcycle - Application Listing

CC	Model	Year	Air Filter	Air Filter Precharger	Custom	Custom Precharger	Oil Filter	Comments
<b>KAWASAKI</b>								
750	ZR7	99-01	KA-0850				KN-401	
750	ZR7	02-03					KN-401	
750	ZR750 Zephyr	91-99	KA-0850				KN-401	
750	ZR750 Zephyr	01-06	KA-0850				KN-401	
750	ZR7S	01-05	KA-0850				KN-401	
750	ZX7 Ninja	89	KA-7589				KN-303*	*Chrome=KN-303C
750	ZX7 Ninja	90	KA-7589				KN-401	
750	ZX7 Ninja	91-92					KN-303*	*Chrome=KN-303C
750	ZX7 Ninja	93-95	KA-0007				KN-303*	*Chrome=KN-303C
750	ZX750	86					KN-401	
750	ZX750	93-99					KN-303*	*Chrome=KN-303C
750	ZX750 Ninja	87-90	KA-7587		RC-2914*		KN-401	*Inc. 4 Filters
750	ZX7R Ninja	91-92					KN-303*	*Chrome=KN-303C
750	ZX7R Ninja	93-94	KA-0007				KN-303*	*Chrome=KN-303C
750	ZX7R Ninja	96-03	KA-7596				KN-303*	*Chrome=KN-303C
750	ZX7RR Ninja	96-97	KA-7596				KN-303*	*Chrome=KN-303C
750	ZX7RR Ninja	98-99					KN-303*	*Chrome=KN-303C
750	ZXR750	89	KA-7589				KN-303*	*Chrome=KN-303C
750	ZXR750R	93-95					KN-303*	*Chrome=KN-303C
800	VN800 Vulcan	95-02	KA-8095				KN-303*	*Chrome=KN-303C
800	VN800 Vulcan	03-05	KA-8095				KN-204*	*Chrome=KN-204C
800	VN800 Vulcan Classic	96-00	KA-8095				KN-303*	*Chrome=KN-303C
800	VN800 Vulcan Classic	04-05	KA-8095				KN-204*	*Chrome=KN-204C
800	VN800 Vulcan Drifter	99-02	KA-8095				KN-303*	*Chrome=KN-303C
800	VN800 Vulcan Drifter	03-06	KA-8095				KN-204*	*Chrome=KN-204C
803	VN800 Vulcan Classic	01	KA-8095				KN-303*	*Chrome=KN-303C
803	VN800 Vulcan Classic	02-03	KA-8095				KN-204*	*Chrome=KN-204C
806	Z800	13-14	KA-1003				KN-303*	*Chrome=KN-303C
806	Z800	15	KA-1003					
806	Z800	16	KA-1003				KN-303*	*Chrome=KN-303C
900	GPZ900R	84-90					KN-401	
900	GPZ900R	91-93	KA-9084				KN-401	
900	GPZ900R	94-96					KN-401	
900	GPZ900R	98-03	KA-9084				KN-401	
900	ZL900 Eliminator	85-86	KA-9084		RC-2774*		KN-401	*Inc. 4 Filters
900	ZX900 Ninja	84-86	KA-9084		RC-2814*		KN-401	*Inc. 4 Filters
900	ZX9R Ninja	94-97	KA-9094				KN-303*	*Chrome=KN-303C
900	ZX9R Ninja	98-01	KA-9098				KN-303*	*Chrome=KN-303C
900	ZX9R Ninja	02-03	KA-9098				KN-204*	*Chrome=KN-204C
903	VN900 Vulcan Classic	06-15	KA-9006				KN-303*	*Chrome=KN-303C
903	VN900 Vulcan Classic	16	KA-9006					
903	VN900 Vulcan Classic LT	06-15	KA-9006				KN-303*	*Chrome=KN-303C
903	VN900 Vulcan Classic LT	16	KA-9006					
903	VN900 Vulcan Custom	07-15	KA-9006				KN-303*	*Chrome=KN-303C
903	VN900 Vulcan Custom	16	KA-9006					
998	KZ1000P Police	82-99	KA-1600		RC-0984*	RC-1820DK <sup>4</sup>	KN-401	*Inc. 4 Filters
998	KZ1000P Police	00-01	KA-1600				KN-401	
998	ZG1000 Concours	02-03	KA-9084		RC-1824*	RC-1820DK <sup>4</sup>	KN-401	*Inc. 4 Filters
998	ZG1000 Concours	04-06	KA-9084				KN-401	
998	ZX1000 Ninja 1000 ABS	15	KA-1111				KN-303*	*Chrome=KN-303C
998	ZX1000 Ninja 1000 ABS	16					KN-303*	*Chrome=KN-303C
998	ZX1000 Ninja H2	15	KA-9915				KN-303*	*Chrome=KN-303C
998	ZX1000 Ninja H2R	15					KN-303*	*Chrome=KN-303C
1000	GPZ1000RX	85-87	KA-0002		RU-2852*		KN-401	*Inc. 2 Filters
1000	GPZ1000RX	88-89					KN-401	
1000	KLV1000	04-05	SU-1002				KN-138*	*Chrome=KN-138C
1000	KLV1000	06					KN-138*	*Chrome=KN-138C

2) Requires Two; 3) Requires Three; 4) Requires Four. The use of custom air filter requires removal of air box. Some custom filters and intakes are not legal for sale or use on any pollution controlled motor vehicle in California or states adopting California emission procedures. See knfilters.com for CARB status on each part for a specific vehicle.

# Motorcycle - Application Listing

CC	Model	Year	Air Filter	Air Filter Precharger	Custom	Custom Precharger	Oil Filter	Comments
<b>KAWASAKI</b>								
1000	KLZ1000 Versys LT	12-13					KN-303*	*Chrome=KN-303C
1000	KLZ1000 Versys LT	15					KN-303*	*Chrome=KN-303C
1000	KZ1000P Police	02-05	KA-1600				KN-401	
1000	Z1000	03-06	KA-1003				KN-204*	*Chrome=KN-204C
1000	Z1000	07-09	KA-1003				KN-303*	*Chrome=KN-303C
1000	Z1000	10	KA-1010				KN-303*	*Chrome=KN-303C
1000	Z1000	11	KA-1010*				KN-303**	*Before VIN ZRT00DE010765/ **Chrome=KN-303C
1000	Z1000	11	KA-1111*				KN-303**	*After VIN ZRT00DE010766/ **Chrome=KN-303C
1000	Z1000	12-15	KA-1111				KN-303*	*Chrome=KN-303C
1000	Z1000 SX	11-12	KA-1111				KN-303*	*Chrome=KN-303C
1000	ZG1000 Concours	86-01	KA-9084		RC-1824*	RC-1820DK <sup>4</sup>	KN-401	*Inc. 4 Filters
1000	ZL1000 Eliminator	87	KA-9084		RC-0984*	RC-1820DK <sup>4</sup>	KN-401	*Inc. 4 Filters
1000	ZL1000 Eliminator	88					KN-401	
1000	ZR1000 ABS	07-09					KN-303*	*Chrome=KN-303C
1000	ZX1000 Ninja ZX-10	88-90	KA-1088		RU-2952*		KN-401	*Inc. 2 Filters
1000	ZX1000 Ninja ZX-10R	04-06	KA-1004				KN-204*	*Chrome=KN-204C
1000	ZX1000 Ninja ZX-10R	07	KA-1004				KN-303*	*Chrome=KN-303C
1000	ZX1000 Ninja ZX-10R	08-10	KA-1008				KN-303*	*Chrome=KN-303C
1000	ZX1000 Ninja ZX-10R	08-10	KA-1008R*				KN-303**	*Race Specific/ **Chrome=KN-303C
1000	ZX1000 Ninja ZX-10R	11-15	KA-1011				KN-303*	*Chrome=KN-303C
1000	ZX1000 Ninja ZX-10R	11-15	KA-1011R*				KN-303**	*Race Specific/ **Chrome=KN-303C
1000	ZX1000 Ninja ZX-10R 30th Anniversary	15	KA-1011				KN-303*	*Chrome=KN-303C
1000	ZX1000 Ninja ZX-10R 30th Anniversary	15	KA-1011R*				KN-303**	*Race Specific/ **Chrome=KN-303C
1000	ZX1000 Ninja ZX-10R ABS	11-15	KA-1011				KN-303*	*Chrome=KN-303C
1000	ZX1000 Ninja ZX-10R ABS	11-15	KA-1011R*				KN-303**	*Race Specific/ **Chrome=KN-303C
1000	ZX1000 Ninja ZX-10R ABS 30th Anniversary	15	KA-1011				KN-303*	*Chrome=KN-303C
1000	ZX1000 Ninja ZX-10R ABS 30th Anniversary	15	KA-1011R*				KN-303**	*Race Specific/ **Chrome=KN-303C
1000	ZX1000R Ninja	85-87	KA-0002		RU-2852*		KN-401	*Inc. 2 Filters
1043	Versys 1000	12-14	KA-1111					
1043	Versys 1000	15	KA-1111				KN-303*	*Chrome=KN-303C
1043	Versys 1000	16	KA-1111					
1043	Z1000	16	KA-1111				KN-303*	*Chrome=KN-303C
1043	Z1000 SX	16	KA-1111				KN-303*	*Chrome=KN-303C
1043	ZX1000 Ninja 1000	11-13	KA-1111				KN-303*	*Chrome=KN-303C
1043	ZX1000 Ninja 1000 ABS	12-14	KA-1111				KN-303*	*Chrome=KN-303C
1100	GPZ1100	95-98					KN-401	
1100	GPZ1100 ABS	97					KN-401	
1100	Z1100	81-86					KN-401	
1100	ZR1100 Zephyr	91					KN-401	
1100	ZR1100 Zephyr	92-95	KA-1192				KN-401	
1100	ZR1100 Zephyr	96					KN-401	
1100	ZR1100 Zephyr	99	KA-1192				KN-401	
1100	ZR1100 Zephyr	02-06					KN-401	
1100	ZR1100 Zephyr RS	96-97	KA-1192				KN-401	
1100	ZR1100 Zephyr RS	99	KA-1192				KN-401	
1100	ZRX1100	96					KN-401	
1100	ZRX1100	97-00	KA-1199				KN-401	
1100	ZX11 Ninja	93-01	KA-1093				KN-401	
1100	ZZR1100	90-92	KA-0004				KN-401	
1100	ZZR1100	93-01	KA-1093				KN-401	
1185	ZG1200 Voyager XII	94-03					KN-401	
1196	ZG1200 Voyager XII	93					KN-401	

2) Requires Two; 3) Requires Three; 4) Requires Four. The use of custom air filter requires removal of air box. Some custom filters and intakes are not legal for sale or use on any pollution controlled motor vehicle in California or states adopting California emission procedures. See knfilters.com for CARB status on each part for a specific vehicle.

# Motorcycle - Application Listing

CC	Model	Year	Air Filter	Air Filter Precharger	Custom	Custom Precharger	Oil Filter	Comments
<b>KAWASAKI</b>								
1198	ZG1200 Voyager XII	86-92					KN-401	
1198	ZX11C Ninja	90-93	KA-0004				KN-401	
1200	ZRX1200	01-06	KA-1199				KN-401	
1200	ZRX1200 Daeg	09	KA-1199				KN-401	
1200	ZRX1200R	07-08	KA-1199				KN-401	
1200	ZX12R Ninja	00-06	KA-1299-1				KN-204*	*Chrome=KN-204C
1200	ZZR1200	02-05	KA-1093				KN-401	
1300	ZN1300 Voyager	83-88	KA-0883				KN-126	
1400	1400GTR	08-11	KA-1406				KN-303*	*Chrome=KN-303C
1400	1400GTR	12					KN-303*	*Chrome=KN-303C
1400	ZG1400 Concours	08-11	KA-1406				KN-303*	*Chrome=KN-303C
1400	ZG1400 Concours	12-14	KA-1406*				KN-303**	*US/ **Chrome=KN-303C
1400	ZG1400 Concours ABS	15-16					KN-303*	*Chrome=KN-303C
1400	ZX14R Ninja	06-11	KA-1406				KN-303*	*Chrome=KN-303C
1400	ZZR1400	06-11	KA-1406				KN-303*	*Chrome=KN-303C
1400	ZZR1400	12					KN-303*	*Chrome=KN-303C
1441	ZX1400 Ninja ZX-14R ABS 30th Anniversary	15					KN-303*	*Chrome=KN-303C
1441	ZX14R Ninja	12-14					KN-303*	*Chrome=KN-303C
1441	ZX14R Ninja	16					KN-303*	*Chrome=KN-303C
1500	VN1500 Vulcan	87-89	KA-1594*				KN-303**	*Exc. SE/ **Chrome=KN-303C
1500	VN1500 Vulcan	90-99	KA-1594				KN-303*	*Chrome=KN-303C
1500	VN1500 Vulcan Classic	96-98	KA-1596				KN-303*	*Chrome=KN-303C
1500	VN1500 Vulcan Classic	99-06	KA-1596				KN-204*	*Chrome=KN-204C
1500	VN1500 Vulcan Classic	07-08	KA-1596				KN-303*	*Chrome=KN-303C
1500	VN1500 Vulcan Classic F/I	00-02	KA-1596				KN-204*	*Chrome=KN-204C
1500	VN1500 Vulcan Classic Tourer F/I	99	KA-1596				KN-303*	*Chrome=KN-303C
1500	VN1500 Vulcan Classic Tourer F/I	00					KN-303*	*Chrome=KN-303C
1500	VN1500 Vulcan Classic Tourer F/I	01					KN-204*	*Chrome=KN-204C
1500	VN1500 Vulcan Classic Tourer F/I	02-03	KA-1596				KN-204*	*Chrome=KN-204C
1500	VN1500 Vulcan Drifter	99-05	KA-1596				KN-204*	*Chrome=KN-204C
1500	VN1500 Vulcan L	96-97	KA-1594				KN-303*	*Chrome=KN-303C
1500	VN1500 Vulcan Mean Streak	02-03	KA-1596				KN-204*	*Chrome=KN-204C
1500	VN1500 Vulcan Nomad	98	KA-1596				KN-303*	*Chrome=KN-303C
1500	VN1500 Vulcan Nomad	99-01	KA-1596				KN-204*	*Chrome=KN-204C
1500	VN1500 Vulcan Nomad F/I	00	KA-1596				KN-303*	*Chrome=KN-303C
1500	VN1500 Vulcan Nomad F/I	01-04	KA-1596				KN-204*	*Chrome=KN-204C
1500	VN1500 Vulcan Voyager	87-93					KN-303*	*Chrome=KN-303C
1500	VN1500 Vulcan VV	94-95					KN-303*	*Chrome=KN-303C
1553	VN1600 Vulcan Classic	03	KA-1603				KN-204*	*Chrome=KN-204C
1600	VN1600 Vulcan Classic	04-06	KA-1603				KN-204*	*Chrome=KN-204C
1600	VN1600 Vulcan Classic	07-08	KA-1603				KN-303*	*Chrome=KN-303C
1600	VN1600 Vulcan Mean Streak	04-06	KA-1596				KN-204*	*Chrome=KN-204C
1600	VN1600 Vulcan Mean Streak	07-08	KA-1596				KN-303*	*Chrome=KN-303C
1600	VN1600 Vulcan Nomad	05-06	KA-1603				KN-204*	*Chrome=KN-204C
1600	VN1600 Vulcan Nomad	07-08	KA-1603				KN-303*	*Chrome=KN-303C
1700	VN1700 Vulcan Classic	09-12	KA-1709				KN-303*	*Chrome=KN-303C
1700	VN1700 Vulcan Classic LT	09-10	KA-1709				KN-303*	*Chrome=KN-303C
1700	VN1700 Vulcan Nomad	09-14	KA-1709				KN-303*	*Chrome=KN-303C
1700	VN1700 Vulcan Nomad	15-16	KA-1709				KN-303*	*Chrome=KN-303C
1700	VN1700 Vulcan Vaquero	11-15	KA-1709				KN-303*	*Chrome=KN-303C
1700	VN1700 Vulcan Voyager	09-15	KA-1709				KN-303*	*Chrome=KN-303C
1700	VN1700 Vulcan Voyager	16	KA-1709				KN-303*	*Chrome=KN-303C
1700	VN1700 Vulcan Voyager ABS	13	KA-1709				KN-303*	*Chrome=KN-303C
2000	VN2000 Vulcan	04-06	KA-2008		RK-3908*	E-3016DK	KN-204**	*Mirrored/ **Chrome=KN-204C
2000	VN2000 Vulcan	04-06	KA-2008		RK-3918*	E-3016DK	KN-204**	*Grooved/ **Chrome=KN-204C
2000	VN2000 Vulcan	04-06	KA-2008		RK-3928*	E-3016DK	KN-204**	*Flamed/ **Chrome=KN-204C
2000	VN2000 Vulcan	07	KA-2008		RK-3908*	E-3016DK	KN-303**	*Mirrored/ **Chrome=KN-303C

2) Requires Two; 3) Requires Three; 4) Requires Four. The use of custom air filter requires removal of air box. Some custom filters and intakes are not legal for sale or use on any pollution controlled motor vehicle in California or states adopting California emission procedures. See knfilters.com for CARB status on each part for a specific vehicle.

# Motorcycle - Application Listing

CC	Model	Year	Air Filter	Air Filter Precharger	Custom	Custom Precharger	Oil Filter	Comments
<b>KAWASAKI</b>								
2000	VN2000 Vulcan	07	KA-2008		RK-3918*	E-3016DK	KN-303**	*Grooved/ **Chrome=KN-303C
2000	VN2000 Vulcan	07	KA-2008		RK-3928*	E-3016DK	KN-303**	*Flamed/ **Chrome=KN-303C
2000	VN2000 Vulcan	08-09	KA-2008				KN-303*	*Chrome=KN-303C
2000	VN2000 Vulcan Classic	06	KA-2008		RK-3908*	E-3016DK	KN-204**	*Mirrored/ **Chrome=KN-204C
2000	VN2000 Vulcan Classic	06	KA-2008		RK-3918*	E-3016DK	KN-204**	*Grooved/ **Chrome=KN-204C
2000	VN2000 Vulcan Classic	06	KA-2008		RK-3928*	E-3016DK	KN-204**	*Flamed/ **Chrome=KN-204C
2000	VN2000 Vulcan Classic	07	KA-2008		RK-3908*	E-3016DK	KN-303**	*Mirrored/ **Chrome=KN-303C
2000	VN2000 Vulcan Classic	07	KA-2008		RK-3918*	E-3016DK	KN-303**	*Grooved/ **Chrome=KN-303C
2000	VN2000 Vulcan Classic	07	KA-2008		RK-3928*	E-3016DK	KN-303**	*Flamed/ **Chrome=KN-303C
2000	VN2000 Vulcan Classic	08-09	KA-2008				KN-303*	*Chrome=KN-303C
2000	VN2000 Vulcan Classic LT	04-05	KA-2008				KN-204*	*Chrome=KN-204C
2000	VN2000 Vulcan Classic LT	06	KA-2008		RK-3908*	E-3016DK	KN-204**	*Mirrored/ **Chrome=KN-204C
2000	VN2000 Vulcan Classic LT	06	KA-2008		RK-3918*	E-3016DK	KN-204**	*Grooved/ **Chrome=KN-204C
2000	VN2000 Vulcan Classic LT	06	KA-2008		RK-3928*	E-3016DK	KN-204**	*Flamed/ **Chrome=KN-204C
2000	VN2000 Vulcan Classic LT	07	KA-2008		RK-3908*	E-3016DK	KN-303**	*Mirrored/ **Chrome=KN-303C
2000	VN2000 Vulcan Classic LT	07	KA-2008		RK-3918*	E-3016DK	KN-303**	*Grooved/ **Chrome=KN-303C
2000	VN2000 Vulcan Classic LT	07	KA-2008		RK-3928*	E-3016DK	KN-303**	*Flamed/ **Chrome=KN-303C
2000	VN2000 Vulcan Classic LT	08-10	KA-2008				KN-303*	*Chrome=KN-303C
2000	VN2000 Vulcan Limited	06	KA-2008		RK-3908*	E-3016DK	KN-204**	*Mirrored/ **Chrome=KN-204C
2000	VN2000 Vulcan Limited	06	KA-2008		RK-3918*	E-3016DK	KN-204**	*Grooved/ **Chrome=KN-204C
2000	VN2000 Vulcan Limited	06	KA-2008		RK-3928*	E-3016DK	KN-204**	*Flamed/ **Chrome=KN-204C
<b>KTM</b>								
85	85 SX 17/14	07	KT-5201	KT-5201DK				
85	85 SX 19/16	07	KT-5201	KT-5201DK				
105	105 SX	07	KT-5201	KT-5201DK				
124	125 SX	98-06	KT-5201	KT-5201DK				
124	125 SX	07-15	KT-4511XD	KT-4511DK				
124	125 SXS	01-06	KT-5201	KT-5201DK				
124	125 SXS	07-08	KT-4511XD	KT-4511DK				
124	RC125	14	KT-1211					
125	125 Duke	11-14	KT-1211				KN-155	
125	125 EGS 6KW	98-99	KT-5201	KT-5201DK				
125	125 EXC	98-05	KT-5201	KT-5201DK				
125	125 EXC 100	01	KT-5201	KT-5201DK				
125	125 EXC 80	01	KT-5201	KT-5201DK				
125	125 EXE 100	00	KT-5201	KT-5201DK				
125	125 EXE 80	00	KT-5201	KT-5201DK				
125	125 Supermoto 100	00-01	KT-5201	KT-5201DK				
125	125 Supermoto 80	00-01	KT-5201	KT-5201DK				
144	144 SX	07-08	KT-4511XD	KT-4511DK				
144	150 SX	09-15	KT-4511XD	KT-4511DK				
144	150 XC	10-14	KT-4511XD	KT-4511DK				
193	200 XC	06-07	KT-5201	KT-5201DK				
193	200 XC	08-09	KT-4511XD	KT-4511DK				
193	200 XC-W	06-07	KT-5201	KT-5201DK				
193	200 XC-W	08-16	KT-4511XD	KT-4511DK				
199	RC200	14	KT-1211					
200	200 Duke	12-14	KT-1211				KN-155	
200	200 EGS	98-99	KT-5201	KT-5201DK				
200	200 EXC	98-05	KT-5201	KT-5201DK				
200	200 EXC	08-09	KT-4511XD	KT-4511DK				
200	200 MXC	98-03	KT-5201	KT-5201DK				
200	200 SX	03-04	KT-5201	KT-5201DK				
249	250 SX	98-06	KT-5201	KT-5201DK				
249	250 SX	07	KT-4511XD	KT-4511DK				
249	250 SX	08	KT-4511XD	KT-4511DK			KN-655	
249	250 SX	10	KT-4511XD	KT-4511DK			KN-655	

2) Requires Two; 3) Requires Three; 4) Requires Four. The use of custom air filter requires removal of air box. Some custom filters and intakes are not legal for sale or use on any pollution controlled motor vehicle in California or states adopting California emission procedures. See knfilters.com for CARB status on each part for a specific vehicle.

# Motorcycle - Application Listing

CC	Model	Year	Air Filter	Air Filter Precharger	Custom	Custom Precharger	Oil Filter	Comments
<b>KTM</b>								
249	250 SX	11-16	KT-4511XD	KT-4511DK				
249	250 SX-F	05-06	KT-5201	KT-5201DK			KN-655	
249	250 SX-F	07-12	KT-4511XD	KT-4511DK			KN-655	
249	250 SX-F	13					KN-652	
249	250 SX-F	14	KT-4511XD	KT-4511DK			KN-652	
249	250 SX-F	15-16					KN-652	
249	250 SXS	01	KT-5201	KT-5201DK				
249	250 SXS	03-06	KT-5201	KT-5201DK				
249	250 SXS	07	KT-4511XD	KT-4511DK			KN-655	
249	250 SXS-F	06	KT-5201	KT-5201DK			KN-655	
249	250 SXS-F	07-08	KT-4511XD	KT-4511DK			KN-655	
249	250 XC	06-07	KT-5201	KT-5201DK				
249	250 XC	08	KT-4511XD	KT-4511DK				
249	250 XC	09-10	KT-4511XD	KT-4511DK			KN-655	
249	250 XC	11-16	KT-4511XD	KT-4511DK				
249	250 XC-F	07	KT-5201	KT-5201DK			KN-655	
249	250 XC-F	08-09	KT-4511XD	KT-4511DK			KN-655	
249	250 XC-F	11-12	KT-4511XD	KT-4511DK			KN-655	
249	250 XC-F	13-16					KN-652	
249	250 XCF-W	06-07	KT-5201	KT-5201DK			KN-655	
249	250 XCF-W	08-13	KT-4511XD	KT-4511DK			KN-655	
249	250 XCF-W	14-16					KN-652	
249	250 XC-W	06-07	KT-5201	KT-5201DK				
249	250 XC-W	08	KT-4511XD	KT-4511DK				
249	250 XC-W	09-10	KT-4511XD	KT-4511DK			KN-655	
249	250 XC-W	11-16	KT-4511XD	KT-4511DK				
250	250 EGS	98-99	KT-5201	KT-5201DK				
250	250 EXC	98-00	KT-5201	KT-5201DK				
250	250 EXC	02	KT-5201	KT-5201DK			KN-155*	*Tall Filter
250	250 EXC	02	KT-5201	KT-5201DK			KN-157*	*Short Filter
250	250 EXC	03	KT-5201	KT-5201DK				
250	250 EXC	04-05	KT-5201	KT-5201DK			KN-155*	*Tall Filter
250	250 EXC	04-05	KT-5201	KT-5201DK			KN-157*	*Short Filter
250	250 EXC	08-09	KT-4511XD	KT-4511DK				
250	250 EXC Racing	01	KT-5201	KT-5201DK			KN-155*	*Tall Filter
250	250 EXC Racing	01	KT-5201	KT-5201DK			KN-157*	*Short Filter
250	250 EXC Racing	03	KT-5201	KT-5201DK			KN-155*	*Tall Filter
250	250 EXC Racing	03	KT-5201	KT-5201DK			KN-157*	*Short Filter
250	250 EXC Racing	06					KN-155*	*Tall Filter
250	250 EXC Racing	06					KN-157*	*Short Filter
250	250 EXC-F	07					KN-655	
250	250 EXC-F	08-09	KT-4511XD	KT-4511DK			KN-655	
250	250 EXC-F	10-14					KN-655	
250	250 EXC-G Racing	03	KT-5201	KT-5201DK			KN-155*	*Tall Filter
250	250 EXC-G Racing	03	KT-5201	KT-5201DK			KN-157*	*Short Filter
250	250 MXC	98-01	KT-5201	KT-5201DK				
293	300 XC	06-07	KT-5201	KT-5201DK				
293	300 XC	08-16	KT-4511XD	KT-4511DK				
293	300 XC-W	06-07	KT-5201	KT-5201DK				
293	300 XC-W	08-16	KT-4511XD	KT-4511DK				
300	300 EGS	98-99	KT-5201	KT-5201DK				
300	300 EXC	98-05	KT-5201	KT-5201DK				
300	300 EXC-E	08	KT-4511XD	KT-4511DK				
300	300 MXC	00-05	KT-5201	KT-5201DK				
300	300 MXC 12LT	98-99	KT-5201	KT-5201DK				
349	350 SX-F	11-16					KN-652	
350	350 EXC-F	12-16					KN-652	

2) Requires Two; 3) Requires Three; 4) Requires Four. The use of custom air filter requires removal of air box. Some custom filters and intakes are not legal for sale or use on any pollution controlled motor vehicle in California or states adopting California emission procedures. See knfilters.com for CARB status on each part for a specific vehicle.

# Motorcycle - Application Listing

CC	Model	Year	Air Filter	Air Filter Precharger	Custom	Custom Precharger	Oil Filter	Comments
<b>KTM</b>								
350	350 Freeride	12					KN-652	
350	350 XC-F	11-16					KN-652	
350	350 XCF-W	12-16					KN-652	
368	380 EGS	98-99	KT-5201	KT-5201DK				
368	380 EXC	98-02	KT-5201	KT-5201DK				
368	380 MXC	00-01	KT-5201	KT-5201DK				
368	380 MXC 12LT	98-99	KT-5201	KT-5201DK				
368	380 SX	98-02	KT-5201	KT-5201DK				
373	RC390	14	KT-1211					
373	RC390	15	KT-1211				KN-155	
390	390 Duke	13-14	KT-1211					
390	390 Duke	15	KT-1211				KN-155	
449	450 EXC	12-14	KT-4511XD	KT-4511DK			KN-655	
449	450 EXC	15	KT-4511XD	KT-4511DK				
449	450 EXC-R	08-10	KT-4511XD	KT-4511DK			KN-652	
449	450 SMR	04-07	KT-5201	KT-5201DK			KN-155*	*Tall Filter
449	450 SMR	04-07	KT-5201	KT-5201DK			KN-157*	*Short Filter
449	450 SMR	08-11					KN-652	
449	450 SMR	12	KT-4511XD	KT-4511DK			KN-652	
449	450 SMR	14					KN-652	
449	450 SX-F	03	KT-5201	KT-5201DK			KN-155*	*Tall Filter
449	450 SX-F	03	KT-5201	KT-5201DK			KN-157*	*Short Filter
449	450 SX-F	07-12	KT-4511XD	KT-4511DK			KN-652	
449	450 SX-F	13-15					KN-655	
449	450 SX-F	16					KN-652	
449	450 SXS	07-08	KT-4511XD	KT-4511DK			KN-652	
449	450 XC-F	08-09	KT-4511XD	KT-4511DK			KN-652	
449	450 XC-W	07	KT-5201	KT-5201DK			KN-155*	*Tall Filter
449	450 XC-W	07	KT-5201	KT-5201DK			KN-157*	*Short Filter
449	450 XC-W	08					KN-652	
449	450 XC-W	09-11	KT-4511XD	KT-4511DK			KN-652	
449	450 XC-W	12-16	KT-4511XD	KT-4511DK			KN-655	
450	450 EXC	03-05	KT-5201	KT-5201DK			KN-155*	*Tall Filter
450	450 EXC	03-05	KT-5201	KT-5201DK			KN-157*	*Short Filter
450	450 EXC	07	KT-5201	KT-5201DK			KN-155*	*Tall Filter
450	450 EXC	07	KT-5201	KT-5201DK			KN-157*	*Short Filter
450	450 EXC Racing	06					KN-155*	*Tall Filter
450	450 EXC Racing	06					KN-157*	*Short Filter
450	450 EXC Racing	07	KT-5201	KT-5201DK			KN-155*	*Tall Filter
450	450 EXC Racing	07	KT-5201	KT-5201DK			KN-157*	*Short Filter
450	450 EXC-G Racing	06	KT-5201	KT-5201DK			KN-155*	*Tall Filter
450	450 EXC-G Racing	06	KT-5201	KT-5201DK			KN-157*	*Short Filter
450	450 EXC-R	11					KN-652	
450	450 MXC	03-05	KT-5201	KT-5201DK			KN-155*	*Tall Filter
450	450 MXC	03-05	KT-5201	KT-5201DK			KN-157*	*Short Filter
450	450 MXC	06					KN-155*	*Tall Filter
450	450 MXC	06					KN-157*	*Short Filter
450	450 Rally	04					KN-155*	*Tall Filter
450	450 Rally	04					KN-156*	*Spin On
450	450 Rally	04					KN-157*	*Short Filter
450	450 SMS	04	KT-5201	KT-5201DK			KN-155*	*Tall Filter
450	450 SMS	04	KT-5201	KT-5201DK			KN-157*	*Short Filter
450	450 SX	06	KT-5201	KT-5201DK			KN-155*	*Tall Filter
450	450 SX	06	KT-5201	KT-5201DK			KN-157*	*Short Filter
450	450 SX Racing	02					KN-155*	*Tall Filter
450	450 SX Racing	02					KN-157*	*Short Filter
450	450 SX Racing	04-05	KT-5201	KT-5201DK			KN-155*	*Tall Filter

2) Requires Two; 3) Requires Three; 4) Requires Four. The use of custom air filter requires removal of air box. Some custom filters and intakes are not legal for sale or use on any pollution controlled motor vehicle in California or states adopting California emission procedures. See knfilters.com for CARB status on each part for a specific vehicle.

# Motorcycle - Application Listing

CC	Model	Year	Air Filter	Air Filter Precharger	Custom	Custom Precharger	Oil Filter	Comments
<b>KTM</b>								
450	450 SX Racing	04-05	KT-5201	KT-5201DK			KN-157*	*Short Filter
450	450 SX Racing	06					KN-155*	*Tall Filter
450	450 SX Racing	06					KN-157*	*Short Filter
450	450 SXS	03-06	KT-5201	KT-5201DK			KN-155*	*Tall Filter
450	450 SXS	03-06	KT-5201	KT-5201DK			KN-157*	*Short Filter
450	450 XC	07	KT-5201	KT-5201DK			KN-155*	*Tall Filter
450	450 XC	07	KT-5201	KT-5201DK			KN-157*	*Short Filter
450	450 XC Cross Country	04	KT-5201	KT-5201DK			KN-155*	*Tall Filter
450	450 XC Cross Country	04	KT-5201	KT-5201DK			KN-157*	*Short Filter
450	450 XC-F	10					KN-652	
450	450 XC-F	13-15					KN-655	
450	450 XC-F	16					KN-652	
450	450 XC-G Racing	06	KT-5201	KT-5201DK			KN-155*	*Tall Filter
450	450 XC-G Racing	06	KT-5201	KT-5201DK			KN-157*	*Short Filter
478	505 XCF	08-09	KT-4511XD	KT-4511DK			KN-652	
505	505 SXF	08	KT-4511XD	KT-4511DK			KN-652	
505	505 SXF	09					KN-652	
510	500 EXC	12-16	KT-4511XD	KT-4511DK			KN-655	
510	500 XC-W	12-16	KT-4511XD	KT-4511DK			KN-655	
510	520 EXC Racing	99					KN-155*	*Tall Filter
510	520 EXC Racing	99					KN-157*	*Short Filter
510	520 EXC Racing	00-02	KT-5201	KT-5201DK			KN-155*	*Tall Filter
510	520 EXC Racing	00-02	KT-5201	KT-5201DK			KN-157*	*Short Filter
510	520 EXC-E	99					KN-155*	*Tall Filter
510	520 EXC-E	99					KN-157*	*Short Filter
510	520 MXC Racing	01-02	KT-5201	KT-5201DK			KN-155*	*Tall Filter
510	520 MXC Racing	01-02	KT-5201	KT-5201DK			KN-157*	*Short Filter
510	520 SX Racing	01-02	KT-5201	KT-5201DK			KN-155*	*Tall Filter
510	520 SX Racing	01-02	KT-5201	KT-5201DK			KN-157*	*Short Filter
520	520 MXC Racing	99-00					KN-155*	*Tall Filter
520	520 MXC Racing	99-00					KN-157*	*Short Filter
520	520 SX Racing	99					KN-155*	*Tall Filter
520	520 SX Racing	99					KN-157*	*Short Filter
520	520 SX Racing	00	KT-5201	KT-5201DK			KN-155*	*Tall Filter
520	520 SX Racing	00	KT-5201	KT-5201DK			KN-157*	*Short Filter
525	525 EXC	05	KT-5201	KT-5201DK			KN-155*	*Tall Filter
525	525 EXC	05	KT-5201	KT-5201DK			KN-157*	*Short Filter
525	525 EXC Racing	03-04	KT-5201	KT-5201DK			KN-155*	*Tall Filter
525	525 EXC Racing	03-04	KT-5201	KT-5201DK			KN-157*	*Short Filter
525	525 EXC Racing	06					KN-155*	*Tall Filter
525	525 EXC Racing	06					KN-157*	*Short Filter
525	525 EXC Racing	07	KT-5201	KT-5201DK			KN-155*	*Tall Filter
525	525 EXC Racing	07	KT-5201	KT-5201DK			KN-157*	*Short Filter
525	525 EXC-G Racing	03-04	KT-5201	KT-5201DK			KN-155*	*Tall Filter
525	525 EXC-G Racing	03-04	KT-5201	KT-5201DK			KN-157*	*Short Filter
525	525 EXC-G Racing	06-07	KT-5201	KT-5201DK			KN-155*	*Tall Filter
525	525 EXC-G Racing	06-07	KT-5201	KT-5201DK			KN-157*	*Short Filter
525	525 MXC	03-05	KT-5201	KT-5201DK			KN-155*	*Tall Filter
525	525 MXC	03-05	KT-5201	KT-5201DK			KN-157*	*Short Filter
525	525 MXC	06-07					KN-155*	*Tall Filter
525	525 MXC	06-07					KN-157*	*Short Filter
525	525 SMR	04-05	KT-5201	KT-5201DK			KN-155*	*Tall Filter
525	525 SMR	04-05	KT-5201	KT-5201DK			KN-157*	*Short Filter
525	525 SMR	06					KN-155*	*Tall Filter
525	525 SMR	06					KN-157*	*Short Filter
525	525 SX	04-06	KT-5201	KT-5201DK			KN-155*	*Tall Filter
525	525 SX	04-06	KT-5201	KT-5201DK			KN-157*	*Short Filter

2) Requires Two; 3) Requires Three; 4) Requires Four. The use of custom air filter requires removal of air box. Some custom filters and intakes are not legal for sale or use on any pollution controlled motor vehicle in California or states adopting California emission procedures. See knfilters.com for CARB status on each part for a specific vehicle.



# Motorcycle - Application Listing

CC	Model	Year	Air Filter	Air Filter Precharger	Custom	Custom Precharger	Oil Filter	Comments
<b>KTM</b>								
525	525 SX Racing	03	KT-5201	KT-5201DK			KN-155*	*Tall Filter
525	525 SX Racing	03	KT-5201	KT-5201DK			KN-157*	*Short Filter
525	525 SX Racing	07					KN-155*	*Tall Filter
525	525 SX Racing	07					KN-157*	*Short Filter
525	525 XC	03-06					KN-155*	*Tall Filter
525	525 XC	03-06					KN-157*	*Short Filter
525	525 XC Desert Racing	07	KT-5201	KT-5201DK			KN-155*	*Tall Filter
525	525 XC Desert Racing	07	KT-5201	KT-5201DK			KN-157*	*Short Filter
525	525 XC-G Racing	06-07	KT-5201	KT-5201DK			KN-155*	*Tall Filter
525	525 XC-G Racing	06-07	KT-5201	KT-5201DK			KN-157*	*Short Filter
525	525 XC-W	03-06					KN-155*	*Tall Filter
525	525 XC-W	03-06					KN-157*	*Short Filter
525	525 XC-W	07	KT-5201	KT-5201DK			KN-155*	*Tall Filter
525	525 XC-W	07	KT-5201	KT-5201DK			KN-157*	*Short Filter
530	530 EXC-R	08-11	KT-4511XD	KT-4511DK			KN-652	
530	530 XC-W	08					KN-652	
530	530 XC-W	09-11	KT-4511XD	KT-4511DK			KN-652	
539	540 SXS Racing	01-04	KT-5201	KT-5201DK			KN-155*	*Tall Filter
539	540 SXS Racing	01-04	KT-5201	KT-5201DK			KN-157*	*Short Filter
540	540 SXS	06	KT-5201	KT-5201DK			KN-155*	*Tall Filter
540	540 SXS	06	KT-5201	KT-5201DK			KN-157*	*Short Filter
540	540 SXS Racing	05	KT-5201	KT-5201DK			KN-155*	*Tall Filter
540	540 SXS Racing	05	KT-5201	KT-5201DK			KN-157*	*Short Filter
560	560 SMR	06-07	KT-5201	KT-5201DK			KN-155*	*Tall Filter
560	560 SMR	06-07	KT-5201	KT-5201DK			KN-157*	*Short Filter
560	560 SMR	08					KN-155*	*Tall Filter
560	560 SMR	08					KN-157*	*Short Filter
609	620 Comp Limited	97					KN-155*	*Short Filter
609	620 Comp Limited	97					KN-156*	*Tall Filter
609	620 Duke	94					KN-155*	*Short Filter
609	620 Duke	94					KN-156*	*Tall Filter
609	620 Duke	96-97					KN-155*	*Short Filter
609	620 Duke	96-97					KN-156*	*Tall Filter
609	620 EXC	95					KN-155*	*Short Filter
609	620 EXC	95					KN-156*	*Tall Filter
609	620 LC4 EXC	97					KN-155*	*Short Filter
609	620 LC4 EXC	97					KN-156*	*Tall Filter
609	620 RXC	95					KN-155*	*Short Filter
609	620 RXC	95					KN-156*	*Tall Filter
609	620 RXC	97					KN-155*	*Short Filter
609	620 RXC	97					KN-156*	*Tall Filter
620	620 EGS	94-97					KN-155*	*Short Filter
620	620 EGS	94-97					KN-156*	*Tall Filter
620	620 EGS-E	97					KN-155*	*Short Filter
620	620 EGS-E	97					KN-156*	*Tall Filter
620	620 Enduro	97					KN-155*	*Short Filter
620	620 Enduro	97					KN-156*	*Tall Filter
620	620 LC4 SX	98					KN-155*	*Short Filter
620	620 LC4 SX	98					KN-156*	*Tall Filter
620	620 SC	99					KN-155*	*Short Filter
620	620 SC	99					KN-156*	*Tall Filter
625	625 SC	02					KN-155*	*Tall Filter
625	625 SC	02					KN-157*	*Short Filter
625	625 SC Supermoto	02					KN-155*	*Tall Filter
625	625 SC Supermoto	02					KN-157*	*Short Filter
625	625 SMC	04-06					KN-155*	*Short Filter
625	625 SMC	04-06					KN-156*	*Tall Filter

2) Requires Two; 3) Requires Three; 4) Requires Four. The use of custom air filter requires removal of air box. Some custom filters and intakes are not legal for sale or use on any pollution controlled motor vehicle in California or states adopting California emission procedures. See knfilters.com for CARB status on each part for a specific vehicle.

# Motorcycle - Application Listing

CC	Model	Year	Air Filter	Air Filter Precharger	Custom	Custom Precharger	Oil Filter	Comments
<b>KTM</b>								
625	625 SXC	02-06					KN-155*	*Tall Filter
625	625 SXC	02-06					KN-157*	*Short Filter
625	625 SXC	07					KN-155*	*Short Filter
625	625 SXC	07					KN-157*	*Tall Filter
625	640 Adventure	98-04					KN-155*	*Short Filter
625	640 Adventure	98-04					KN-156*	*Tall Filter
625	640 Duke II	99-04					KN-155*	*Short Filter
625	640 Duke II	99-04					KN-156*	*Tall Filter
625	640 Duke-E	98					KN-155*	*Short Filter
625	640 Duke-E	98					KN-156*	*Tall Filter
625	640 Enduro	03-04					KN-155*	*Short Filter
625	640 Enduro	03-04					KN-156*	*Tall Filter
625	640 LC4	98-01					KN-155*	*Short Filter
625	640 LC4	98-01					KN-156*	*Tall Filter
625	640 LC4 Supermoto	01					KN-155*	*Short Filter
625	640 LC4 Supermoto	01					KN-156*	*Tall Filter
625	640 LC4-E	00-02					KN-155*	*Short Filter
625	640 LC4-E	00-02					KN-156*	*Tall Filter
625	640 LC4-E Supermoto	01					KN-155*	*Short Filter
625	640 LC4-E Supermoto	01					KN-156*	*Tall Filter
625	640 LC-E	00					KN-155*	*Short Filter
625	640 LC-E	00					KN-156*	*Tall Filter
625	640 Supermoto	99-00					KN-155*	*Short Filter
625	640 Supermoto	99-00					KN-156*	*Tall Filter
625	640 Supermoto	02-04					KN-155*	*Short Filter
625	640 Supermoto	02-04					KN-156*	*Tall Filter
640	640 Adventure	05-08					KN-155*	*Short Filter
640	640 Adventure	05-08					KN-156*	*Tall Filter
640	640 Duke II	05-06					KN-155*	*Short Filter
640	640 Duke II	05-06					KN-156*	*Tall Filter
640	640 Enduro	05					KN-155*	*Short Filter
640	640 Enduro	05					KN-156*	*Tall Filter
640	640 LC4	97					KN-155*	*Short Filter
640	640 LC4	97					KN-156*	*Tall Filter
640	640 Supermoto	05					KN-155*	*Short Filter
640	640 Supermoto	05					KN-156*	*Tall Filter
650	650 LC4 Supermoto	06					KN-155*	*Tall Filter
650	650 LC4 Supermoto	06					KN-157*	*Short Filter
660	660 LC4 Rally	97					KN-155*	*Short Filter
660	660 LC4 Rally	97					KN-156*	*Tall Filter
660	660 Rally	01-02					KN-155*	*Tall Filter
660	660 Rally	01-02					KN-156*	*Spin On
660	660 Rally	01-02					KN-157*	*Short Filter
660	660 Rally	03					KN-155*	*Short Filter
660	660 Rally	03					KN-156*	*Tall Filter
660	660 Rally	04-06					KN-155*	*Tall Filter
660	660 Rally	04-06					KN-156*	*Spin On
660	660 Rally	04-07					KN-157*	*Short Filter
660	660 Rally	07					KN-155*	*Gearbox Filter
660	660 Rally	07					KN-156*	*Tall Filter
660	660 SMC	03-05					KN-155*	*Tall Filter
660	660 SMC	03-05					KN-157*	*Short Filter
660	660 SMS	04					KN-155*	*Tall Filter
660	660 SMS	04					KN-157*	*Short Filter
690	690 Duke	08-11	KT-6907				KN-155*	*Tall Filter
690	690 Duke	08-11	KT-6907				KN-157*	*Short Filter
690	690 Duke	12					KN-155*	*Short Filter

2) Requires Two; 3) Requires Three; 4) Requires Four. The use of custom air filter requires removal of air box. Some custom filters and intakes are not legal for sale or use on any pollution controlled motor vehicle in California or states adopting California emission procedures. See knfilters.com for CARB status on each part for a specific vehicle.

# Motorcycle - Application Listing

CC	Model	Year	Air Filter	Air Filter Precharger	Custom	Custom Precharger	Oil Filter	Comments
<b>KTM</b>								
690	690 Duke	13-16	KT-6912				KN-155*	*Tall Filter
690	690 Duke	13-16	KT-6912				KN-651*	*Short Filter
690	690 Enduro	08	KT-6908				KN-155*	*Tall Filter
690	690 Enduro	08	KT-6908				KN-157*	*Short Filter
690	690 Enduro	09-10					KN-155*	*Tall Filter
690	690 Enduro	09-10					KN-157*	*Short Filter
690	690 Enduro R	09-11	KT-6908				KN-157*	*Short Filter
690	690 Enduro R	09-14	KT-6908				KN-155*	*Tall Filter
690	690 Enduro R	12-14	KT-6908				KN-651*	*Short Filter
690	690 Enduro R	15-16					KN-155*	*Tall Filter
690	690 Enduro R	15-16					KN-651*	*Short Filter
690	690 SMC	08-11	KT-6908				KN-155*	*Tall Filter
690	690 SMC	08-11	KT-6908				KN-157*	*Short Filter
690	690 SMC	12	KT-6908				KN-155*	*Short Filter
690	690 Supermoto	07	KT-6907				KN-655*	*Tall Filter
690	690 Supermoto	07-08	KT-6907				KN-157*	*Short Filter
690	690 Supermoto	08	KT-6907				KN-155*	*Tall Filter
690	Duke R	13					KN-155*	*Short Filter
690	Duke R	14-15	KT-6912				KN-155	
942	950 Adventure	02					KN-158	
942	950 Adventure	03-06	KT-9504				KN-158	
942	950 Adventure S	03-06	KT-9504				KN-158	
942	950 Super Enduro R	06	KT-9504					
942	950 Super Enduro R	07-09	KT-9504				KN-158	
942	950 Supermoto	06-08	KT-9504				KN-158	
942	950 Supermoto R	07	KT-9504				KN-158	
942	950 Supermoto R	08	KT-9504					
950	950 Super Enduro R	11					KN-158	
950	950 Supermoto	05					KN-158	
999	990 Adventure	07-13	KT-9907				KN-158	
999	990 Adventure	14					KN-158	
999	990 Adventure R	09-12	KT-9907				KN-158	
999	990 Adventure S	07-08	KT-9907					
999	990 SMR	10					KN-158	
999	990 SMT	10-13	KT-9907				KN-158	
999	990 Super Duke	05-06					KN-158	
999	990 Super Duke	07-08	KT-9907				KN-158	
999	990 Super Duke	09-11					KN-158	
999	990 Super Duke R	08-11					KN-158	
999	990 Supermoto	10-11	KT-9907				KN-158	
999	990 Supermoto R	10-11	KT-9907				KN-158	
999	990 Supermoto T	10-11	KT-9907				KN-158	
999	990 Supermoto T	13	KT-9907				KN-158	
1150	1190 RC8	08-09	KT-1108				KN-158	
1190	1190 RC8	10-11	KT-1108				KN-158	
1190	1190 RC8R	10					KN-158	
1190	1190 RC8R	11-14	KT-1108				KN-158	
1190	1190 RC8R	15					KN-158	
1190	RC8R	14					KN-158	
1195	1190 Adventure	13-14	KT-1113				KN-158	
1195	1190 Adventure	15-16					KN-158	
1195	1190 Adventure R	13-14	KT-1113				KN-158	
1195	1190 Adventure R	15-16					KN-158	
1301	1290 Super Adventure	15-16					KN-158	
1301	1290 Super Duke R	13	KT-1113					
1301	1290 Super Duke R	14	KT-1113				KN-158	
1301	1290 Super Duke R	15-16					KN-158	

2) Requires Two; 3) Requires Three; 4) Requires Four. The use of custom air filter requires removal of air box. Some custom filters and intakes are not legal for sale or use on any pollution controlled motor vehicle in California or states adopting California emission procedures. See knfilters.com for CARB status on each part for a specific vehicle.

# Motorcycle - Application Listing

CC	Model	Year	Air Filter	Air Filter Precharger	Custom	Custom Precharger	Oil Filter	Comments
<b>SUZUKI</b>								
60	RM60	03	KA-6085					
65	RM65	04-05	KA-8088	22-8088PK				
79	RM80	90-01	SU-8086					
80	RM80	86-89	SU-8086					
85	RM85	02-10	SU-8086					
85	RM85	12-13	SU-8086					
85	RM85L	03-10	SU-8086					
85	RM85L	12-13	SU-8086					
100	RM100	03	KA-8088	22-8088PK				
110	DRZ110	03-05	KA-1102				KN-112	
124	DRZ125L	10	KA-1203				KN-132	
124	DRZ125L	12-14	KA-1203				KN-132	
124	DRZ125L	15-16	KA-1203					
125	DR125	86-88					KN-132	
125	DR125	97					KN-132	
125	DR125SE	98-00					KN-132	
125	DR125SE Raider	85-96					KN-132	
125	DR125SM	07-09					KN-131	
125	DR125X	98-00					KN-132	
125	DR125Y	98-00					KN-132	
125	DRZ125	03-10	KA-1203				KN-132	
125	DRZ125	12-14	KA-1203				KN-132	
125	DRZ125L	03-09	KA-1203				KN-132	
125	GS125	83-00					KN-131*	*Disc Brake
125	GZ125 Marauder	99-10					KN-131	
125	RM125	96-00	SU-2596					
125	RM125	06-08	YA-2506XD	YA-4098-1DK				
125	TU125XT	99					KN-131	
125	VL125LC Intruder	00-06					KN-136	
199	DR200S	15					KN-132	
200	DR200	86-88					KN-132	
200	DR200S	86-91					KN-132	
200	DR200SE	96-10					KN-132	
248	GW250	13	SU-2513				KN-138*	*Chrome=KN-138C
248	GW250	14	SU-2513					
248	GW250	15	SU-2513				KN-138*	*Chrome=KN-138C
248	GW250F	15	SU-2513				KN-138*	*Chrome=KN-138C
249	RMZ250	10-15	YA-2506XD	YA-4098-1DK			KN-207	
249	RMZ250	16	YA-2506XD	YA-4098-1DK				
250	DR250S	82-88					KN-136	
250	DR250S	90-93	SU-3590				KN-136	
250	DR250S	94-96					KN-136	
250	DR250SE	93-95	SU-3590				KN-136	
250	DR250SE Off Road	97-99					KN-136	
250	DRZ250	01-07	SU-2501				KN-136	
250	GSF250	92-95					KN-531	
250	GSF250	97					KN-531	
250	GSXR250	87-89					KN-133	
250	GZ250 Marauder	99-10					KN-136	
250	RM250	99-04	SU-2596					
250	RM250	06-08	YA-2506XD	YA-4098-1DK				
250	RMZ250	04-06	KA-2504				KN-207	
250	RMZ250	07-09	YA-2506XD	YA-4098-1DK			KN-207	
250	TU250X	98-00					KN-136	
250	TU250X	09-15					KN-136	
250	VL250LC Intruder	00-04					KN-136	
350	DR350	90-99	SU-3590				KN-136	

2) Requires Two; 3) Requires Three; 4) Requires Four. The use of custom air filter requires removal of air box. Some custom filters and intakes are not legal for sale or use on any pollution controlled motor vehicle in California or states adopting California emission procedures. See knfilters.com for CARB status on each part for a specific vehicle.

# Motorcycle - Application Listing

CC	Model	Year	Air Filter	Air Filter Precharger	Custom	Custom Precharger	Oil Filter	Comments
<b>SUZUKI</b>								
350	DR350	00					KN-136	
350	DR350 Off Road	90-93					KN-136	
350	DR350 Off Road	97-98					KN-136	
350	DR350S	90-96	SU-3590				KN-136	
350	DR350SE	97-99	SU-3590				KN-136	
350	DR350SE	00					KN-136	
350	SG350	91-92					KN-136	
398	DRZ400S	12-13	SU-4000	SU-4000PK			KN-139	
398	DRZ400S	14	SU-4000	SU-4000PK				
398	DRZ400S	15	SU-4000	SU-4000PK			KN-139	
398	DRZ400S	16	SU-4000	SU-4000PK				
398	DRZ400SM	13	SU-4000	SU-4000PK			KN-139	
398	DRZ400SM	14	SU-4000	SU-4000PK				
398	DRZ400SM	15	SU-4000	SU-4000PK			KN-139	
398	DRZ400SM	16	SU-4000	SU-4000PK				
399	GSF400 Bandit	90					KN-133	
399	GSF400 Bandit	91-95	SU-0008				KN-133	
399	GSXR400	90-92					KN-138*	*Chrome=KN-138C
400	DRZ400	00-04	SU-4000	SU-4000PK			KN-139	
400	DRZ400E	00-08	SU-4000	SU-4000PK			KN-139	
400	DRZ400S	00-11	SU-4000	SU-4000PK			KN-139	
400	DRZ400SM	05-10	SU-4000	SU-4000PK			KN-139	
400	GSXR400	85-89					KN-133	
449	RMZ450	10-15	YA-2506XD	YA-4098-1DK			KN-207	
449	RMZ450	16	YA-2506XD	YA-4098-1DK				
450	GS450E	84-88					KN-133	
450	GS450L	85-88			RC-0982*	RC-1820DK <sup>2</sup>	KN-133	*Inc. 2 Filters
450	RMX450Z	10-12					KN-207	
450	RMZ450	05-09	YA-2506XD	YA-4098-1DK			KN-207	
500	GS500	01-02	SU-5589		RU-2970		KN-133	
500	GS500	03-07	SU-5589				KN-133	
500	GS500E	88					KN-133	
500	GS500E	89-00	SU-5589		RU-2970		KN-133	
500	GS500F	04-09	SU-5589				KN-133	
500	GS500F	10					KN-133	
500	GS500H	07-09					KN-133	
550	GS550ES	83-86	SU-5503				KN-133	
550	GS550L	85-86	SU-5503				KN-133	
550	GSX550	83-87					KN-133	
580	RF600R	93					KN-138*	*Chrome=KN-138C
580	RF600R	94-98	SU-9094				KN-138*	*Chrome=KN-138C
599	VS600GL Intruder	95-97					KN-138*	*Chrome=KN-138C
600	DR600	85-91					KN-137	
600	DR600R/L/M	90-91					KN-137	
600	DR600RSE/M	91					KN-137	
600	GSF600 Bandit	95					KN-138*	*Chrome=KN-138C
600	GSF600 Bandit	96-99	SU-7593				KN-138*	*Chrome=KN-138C
600	GSF600 Bandit	00-03	SU-6000				KN-138*	*Chrome=KN-138C
600	GSF600 Bandit	04					KN-138*	*Chrome=KN-138C
600	GSF600 Bandit S	95					KN-138*	*Chrome=KN-138C
600	GSF600 Bandit S	96-99	SU-7593				KN-138*	*Chrome=KN-138C
600	GSF600 Bandit S	00-04	SU-6000				KN-138*	*Chrome=KN-138C
600	GSR600	06-10	SU-6006				KN-138*	*Chrome=KN-138C
600	GSR600	11	SU-6006				KN-138*	*Chrome=KN-138C
600	GSX600F Katana	88-89	SU-7592		RC-1824*	RC-1820DK <sup>4</sup>	KN-138**	*Inc. 4 Filters/ **Chrome=KN-138C
600	GSX600F Katana	90-03	SU-7592		RU-2922*		KN-138**	*Inc. 2 Filters/ **Chrome=KN-138C

2) Requires Two; 3) Requires Three; 4) Requires Four. The use of custom air filter requires removal of air box. Some custom filters and intakes are not legal for sale or use on any pollution controlled motor vehicle in California or states adopting California emission procedures. See knfilters.com for CARB status on each part for a specific vehicle.

# Motorcycle - Application Listing

CC	Model	Year	Air Filter	Air Filter Precharger	Custom	Custom Precharger	Oil Filter	Comments
<b>SUZUKI</b>								
600	GSX600F Katana	04-06	SU-7592				KN-138*	*Chrome=KN-138C
600	GSXR600	97-00	SU-7596				KN-138*	*Chrome=KN-138C
600	GSXR600	01-03	SU-7500				KN-138*	*Chrome=KN-138C
600	GSXR600	04-05	SU-7504				KN-138*	*Chrome=KN-138C
600	GSXR600	06-10	SU-7506				KN-138*	*Chrome=KN-138C
600	GSXR600	06-10	SU-7506R*				KN-138**	*Race Specific/ **Chrome=KN-138C
600	GSXR600	11-15	SU-7511				KN-138*	*Chrome=KN-138C
600	GSXR600	11-15	SU-7511R*				KN-138**	*Race Specific/ **Chrome=KN-138C
600	GSXR600W	92-93	SU-7593				KN-138*	*Chrome=KN-138C
600	VS600 GLF	98					KN-138*	*Chrome=KN-138C
644	DR650S	15	SU-6596	SU-6596DK			KN-137	
644	DR650S	16	SU-6596	SU-6596DK				
644	DR650SE	10-14	SU-6596	SU-6596DK			KN-137	
645	DL650 V-Strom	04-12	SU-1002				KN-138*	*Chrome=KN-138C
645	DL650 V-Strom	16	SU-1002					
645	DL650A V-Strom ABS	07-09	SU-1002				KN-138*	*Chrome=KN-138C
645	DL650A V-Strom ABS	11-13	SU-1002				KN-138*	*Chrome=KN-138C
645	DL650A V-Strom ABS	14	SU-1002					
645	DL650A V-Strom ABS	15	SU-1002				KN-138*	*Chrome=KN-138C
645	DL650A V-Strom ABS Adventure	12-13	SU-1002				KN-138*	*Chrome=KN-138C
645	DL650A V-Strom ABS Adventure	14	SU-1002					
645	DL650A V-Strom ABS Adventure	15	SU-1002				KN-138*	*Chrome=KN-138C
645	DL650A V-Strom XT ABS	15	SU-1002				KN-138*	*Chrome=KN-138C
645	SFV650	13-14	SU-6509					
645	SFV650	15					KN-138*	*Chrome=KN-138C
650	Boulevard S40	05-09	SU-6595				KN-137	
650	DR650S	90-95	SU-6590	SU-6590PY			KN-137	
650	DR650SE	96-09	SU-6596	SU-6596DK			KN-137	
650	DS650	92-93					KN-137	
650	GSF650 Bandit	05-10	SU-6505				KN-138*	*Chrome=KN-138C
650	GSF650 Bandit	11-12					KN-138*	*Chrome=KN-138C
650	GSF650 Bandit S	05-09	SU-6505				KN-138*	*Chrome=KN-138C
650	GSX650F	08-09	SU-6505				KN-138*	*Chrome=KN-138C
650	LS650 Boulevard	05-11					KN-137	
650	LS650 Savage	86-04	SU-6595				KN-137	
650	LS650 Savage	05-07					KN-137	
650	LS650 Savage	09					KN-137	
650	SV650	99-02	SU-6599				KN-138*	*Chrome=KN-138C
650	SV650	03-09	SU-6503				KN-138*	*Chrome=KN-138C
650	SV650 SA	10					KN-138*	*Chrome=KN-138C
650	SV650A ABS	07	SU-6503					
650	SV650S	99-02	SU-6599				KN-138*	*Chrome=KN-138C
650	SV650S	03-09	SU-6503				KN-138*	*Chrome=KN-138C
650	SV650S	10					KN-138*	*Chrome=KN-138C
650	SV650SF	09	SU-6503				KN-138*	*Chrome=KN-138C
650	XF650 Freewind	97-02					KN-137	
650	XN85 D Turbo	83-86					KN-133	
652	Boulevard S40	11-14	SU-6595					
652	Boulevard S40	15	SU-6595				KN-137	
652	SFV650	09-12	SU-6509				KN-138*	*Chrome=KN-138C
656	GSX650F	10-13	SU-6505				KN-138*	*Chrome=KN-138C
700	GS700	86	SU-7503		RC-0984*	RC-1820DK <sup>4</sup>		*Inc. 4 Filters
700	GV700 Madura	86					KN-134	
700	VS700 Intruder	86	SU-7086				KN-134	
700	VS700 Intruder	87	SU-7086				KN-138*	*Chrome=KN-138C
700	VS700 Intruder	88					KN-138*	*Chrome=KN-138C

2) Requires Two; 3) Requires Three; 4) Requires Four. The use of custom air filter requires removal of air box. Some custom filters and intakes are not legal for sale or use on any pollution controlled motor vehicle in California or states adopting California emission procedures. See knfilters.com for CARB status on each part for a specific vehicle.

# Motorcycle - Application Listing

CC	Model	Year	Air Filter	Air Filter Precharger	Custom	Custom Precharger	Oil Filter	Comments
<b>SUZUKI</b>								
749	GSXS750	15-16	SU-6006					
749	GSXS750Z	15	SU-6006					
750	DR750	88-89					KN-137	
750	GSR750	11-14	SU-6006				KN-138*	*Chrome=KN-138C
750	GSX750	86-89					KN-133	
750	GSX750	01-02					KN-137	
750	GSX750 Katana	84-86					KN-133	
750	GSX750 Retro	98-99	SU-5589				KN-138*	*Chrome=KN-138C
750	GSX750 Retro	00-02					KN-138*	*Chrome=KN-138C
750	GSX750F Katana	89-02	SU-7592		RU-2922*		KN-138**	*Inc. 2 Filters/ **Chrome=KN-138C
750	GSX750F Katana	03-06	SU-7592				KN-138*	*Chrome=KN-138C
750	GSXR750	86-87			RC-1824*	RC-1820DK 4	KN-134	*Inc. 4 Filters
750	GSXR750	88-92	SU-7588		RU-2922*		KN-138**	*Inc. 2 Filters/ **Chrome=KN-138C
750	GSXR750	96-99	SU-7596				KN-138*	*Chrome=KN-138C
750	GSXR750	00-03	SU-7500				KN-138*	*Chrome=KN-138C
750	GSXR750	04-05	SU-7504				KN-138*	*Chrome=KN-138C
750	GSXR750	06-10	SU-7506				KN-138*	*Chrome=KN-138C
750	GSXR750	06-10	SU-7506R*				KN-138**	*Race Specific/ **Chrome=KN-138C
750	GSXR750	11-15	SU-7511				KN-138*	*Chrome=KN-138C
750	GSXR750	11-15	SU-7511R*				KN-138**	*Race Specific/ **Chrome=KN-138C
750	GSXR750 50th Ann. Edition	14	SU-7511				KN-138*	*Chrome=KN-138C
750	GSXR750 50th Ann. Edition	14	SU-7511R*				KN-138**	*Race Specific/ **Chrome=KN-138C
750	GSXR750 Sling Shot	88-91					KN-138*	*Chrome=KN-138C
750	GSXR750F	85-87					KN-134	
750	GSXR750G	85-87					KN-134	
750	GSXR750H	85-87					KN-134	
750	GSXR750HG	85-87					KN-134	
750	GSXR750R	86			RC-1824*	RC-1820DK 4	KN-134	*Inc. 4 Filters
750	GSXR750R	87					KN-134	
750	GSXR750W	93-95	SU-7593				KN-138*	*Chrome=KN-138C
750	GSXR750XH	85-87					KN-134	
750	VS750	85-86					KN-134	
750	VS750 Intruder	87					KN-138*	*Chrome=KN-138C
750	VS750 Intruder	88-91	SU-7086				KN-138*	*Chrome=KN-138C
778	DR800	90-94					KN-137	
778	DR800	95-97	SU-0006				KN-137	
778	DR800	98-99					KN-137	
800	Boulevard S50	05-09	SU-7086				KN-138*	*Chrome=KN-138C
800	DR800	88-89					KN-137	
800	DR800	00					KN-137	
800	M800 Intruder	05-09					KN-138*	*Chrome=KN-138C
800	M800 Intruder	11					KN-138*	*Chrome=KN-138C
800	VL800LC Intruder Volusia	01-04	SU-8001				KN-138*	*Chrome=KN-138C
800	VS800 Intruder	92-04	SU-7086				KN-138*	*Chrome=KN-138C
800	VS800 Intruder	05-09					KN-138*	*Chrome=KN-138C
800	VX800	97					KN-138*	*Chrome=KN-138C
800	VZ800 Intruder M800	05-08	SU-8005				KN-138*	*Chrome=KN-138C
800	VZ800 Intruder M800	09	SU-8009				KN-138*	*Chrome=KN-138C
800	VZ800 Marauder	97-04	SU-5589*				KN-138**	*Jet kit required, purchase separately/ **Chrome=KN-138C
800	VZ800 Marauder	05-06	SU-8005					
800	VZ800 Marauder	07-08	SU-8005				KN-138*	*Chrome=KN-138C
801	VX800	90-96					KN-138*	*Chrome=KN-138C

2) Requires Two; 3) Requires Three; 4) Requires Four. The use of custom air filter requires removal of air box. Some custom filters and intakes are not legal for sale or use on any pollution controlled motor vehicle in California or states adopting California emission procedures. See knfilters.com for CARB status on each part for a specific vehicle.

# Motorcycle - Application Listing

CC	Model	Year	Air Filter	Air Filter Precharger	Custom	Custom Precharger	Oil Filter	Comments
<b>SUZUKI</b>								
805	Boulevard C50	05-08	SU-8001				KN-138*	*Chrome=KN-138C
805	Boulevard C50	09-13	SU-8009				KN-138*	*Chrome=KN-138C
805	Boulevard C50	15	SU-8009				KN-138*	*Chrome=KN-138C
805	Boulevard C50 Black	05-07	SU-8001				KN-138*	*Chrome=KN-138C
805	Boulevard C50 BOSS	14	SU-8009				KN-138*	*Chrome=KN-138C
805	Boulevard C50 Custom Volusia	08					KN-138*	*Chrome=KN-138C
805	Boulevard C50 Limited Edition	07-08	SU-8001				KN-138*	*Chrome=KN-138C
805	Boulevard C50 Special Edition	09	SU-8009				KN-138*	*Chrome=KN-138C
805	Boulevard C50 Special Edition	13	SU-8009				KN-138*	*Chrome=KN-138C
805	Boulevard C50 Volusia	07-08					KN-138*	*Chrome=KN-138C
805	Boulevard C50T	05-08	SU-8001				KN-138*	*Chrome=KN-138C
805	Boulevard C50T	09	SU-8009				KN-138*	*Chrome=KN-138C
805	Boulevard C50T	14-15	SU-8009				KN-138*	*Chrome=KN-138C
805	Boulevard M50	05-08	SU-8005				KN-138*	*Chrome=KN-138C
805	Boulevard M50	09-12	SU-8009				KN-138*	*Chrome=KN-138C
805	Boulevard M50	13	SU-8009					
805	Boulevard M50	15					KN-138*	*Chrome=KN-138C
805	Boulevard M50 Black	05-06	SU-8005				KN-138*	*Chrome=KN-138C
805	Boulevard M50 Limited	07	SU-8005				KN-138*	*Chrome=KN-138C
805	Boulevard M50 Special Edition	09					KN-138*	*Chrome=KN-138C
805	VL800 Intruder C800	05-06					KN-138*	*Chrome=KN-138C
805	VL800 Intruder C800	07-08	SU-8001				KN-138*	*Chrome=KN-138C
805	VL800 Intruder C800	09-13	SU-8009				KN-138*	*Chrome=KN-138C
805	VZ800 Marauder	09	SU-8009				KN-138*	*Chrome=KN-138C
900	RF900	00					KN-138*	*Chrome=KN-138C
938	RF900	98-99					KN-138*	*Chrome=KN-138C
938	RF900R	94-97	SU-9094				KN-138*	*Chrome=KN-138C
996	DL1000 V-Strom	02-10	SU-1002				KN-138*	*Chrome=KN-138C
996	DL1000 V-Strom	12-13	SU-1002				KN-138*	*Chrome=KN-138C
996	DL1000 V-Strom Adventure	12	SU-1002				KN-138*	*Chrome=KN-138C
996	DL1000 V-Strom GT	04	SU-1002				KN-138*	*Chrome=KN-138C
996	DL1000 V-Strom Touring	07	SU-1002				KN-138*	*Chrome=KN-138C
999	GSXR1000	01-04	SU-7500				KN-138*	*Chrome=KN-138C
999	GSXR1000	05-08	SU-1005				KN-138*	*Chrome=KN-138C
999	GSXR1000	05-08	SU-1005R*				KN-138**	*Race Specific/ **Chrome=KN-138C
999	GSXR1000	09-15	SU-1009				KN-138*	*Chrome=KN-138C
999	GSXR1000	09-15	SU-1009R*				KN-138**	*Race Specific/ **Chrome=KN-138C
999	GSXR1000	16	SU-1009					
999	GSXR1000	16	SU-1009R*					*Race Specific
999	GSXR1000 1 Million C.E.	13	SU-1009				KN-138*	*Chrome=KN-138C
999	GSXR1000 1 Million C.E.	13	SU-1009R*				KN-138**	*Race Specific/ **Chrome=KN-138C
999	GSXR1000 SE	14	SU-1009				KN-138*	*Chrome=KN-138C
999	GSXR1000 SE	14	SU-1009R*				KN-138**	*Race Specific/ **Chrome=KN-138C
1000	SV1000	03-04	SU-6503				KN-138*	*Chrome=KN-138C
1000	SV1000	05-07					KN-138*	*Chrome=KN-138C
1000	SV1000S	03-07	SU-6503				KN-138*	*Chrome=KN-138C
1000	TL1000R	98-03	SU-0015				KN-138*	*Chrome=KN-138C
1000	TL1000S	97-01	SU-0007-A				KN-138*	*Chrome=KN-138C
1037	DL1000 V-Strom ABS	14-15	SU-1014				KN-138*	*Chrome=KN-138C
1037	DL1000 V-Strom ABS	16	SU-1014					
1037	DL1000 V-Strom ABS Adventure	14-15	SU-1014				KN-138*	*Chrome=KN-138C
1052	GSXR1100	86-88			RC-1824*	RC-1820DK <sup>4</sup>	KN-138**	*Inc. 4 Filters/ **Chrome=KN-138C
1052	GSXR1100	89-92	SU-7588		RU-2922*		KN-138**	*Inc. 2 Filters/ **Chrome=KN-138C

2) Requires Two; 3) Requires Three; 4) Requires Four. The use of custom air filter requires removal of air box. Some custom filters and intakes are not legal for sale or use on any pollution controlled motor vehicle in California or states adopting California emission procedures. See knfilters.com for CARB status on each part for a specific vehicle.



# Motorcycle - Application Listing

CC	Model	Year	Air Filter	Air Filter Precharger	Custom	Custom Precharger	Oil Filter	Comments
<b>SUZUKI</b>								
1052	GSXR1100	94-98	SU-7593				KN-138*	*Chrome=KN-138C
1074	GSXR1100	93	SU-7593		RU-2922*		KN-138**	*Inc. 2 Filters/ **Chrome=KN-138C
1100	GS1100GK	85-86					KN-133	
1100	GSX1100F Katana	87-94	SU-7592		RC-1824*	RC-1820DK <sup>4</sup>	KN-138**	*Inc. 4 Filters/ **Chrome=KN-138C
1100	GSX1100F Katana	95-96					KN-138*	*Chrome=KN-138C
1118	GSX1100G	91-96	SU-1191				KN-138*	*Chrome=KN-138C
1150	GS1150E	83-86	SU-1284		RC-0984*	RC-1820DK <sup>4</sup>	KN-133	*Inc. 4 Filters
1200	GSF1200 Bandit	00					KN-138*	*Chrome=KN-138C
1200	GSF1200 Bandit	01-03	SU-6000				KN-138*	*Chrome=KN-138C
1200	GSF1200 Bandit	04-05					KN-138*	*Chrome=KN-138C
1200	GSF1200 Bandit	06	SU-6505				KN-138*	*Chrome=KN-138C
1200	GSF1200 Bandit S	96-00	SU-7593		RU-2922*		KN-138**	*Inc. 2 Filters/ **Chrome=KN-138C
1200	GSF1200 Bandit S	01-05	SU-6000				KN-138*	*Chrome=KN-138C
1200	GSF1200 Bandit S	06	SU-6505				KN-138*	*Chrome=KN-138C
1200	GSX1200 Inazuma	99-00					KN-138*	*Chrome=KN-138C
1200	GV1200 Madura	85-86	SU-5589				KN-134	
1250	GSF1250 Bandit	09-13	SU-6505				KN-138*	*Chrome=KN-138C
1250	GSF1250 Bandit S	07-12	SU-6505				KN-138*	*Chrome=KN-138C
1250	GSX1250FA	11	SU-6505				KN-138*	*Chrome=KN-138C
1250	GSX1250FA	12-13	SU-6505				KN-138*	*Chrome=KN-138C
1300	GSX1300R Hayabusa	99-07	SU-1399				KN-138*	*Chrome=KN-138C
1340	GSX1300BK B-King	07-12	SU-1348				KN-138*	*Chrome=KN-138C
1340	GSX1300R Hayabusa	08-15	SU-1308				KN-138*	*Chrome=KN-138C
1340	GSX1300R Hayabusa	08-15	SU-1308R*				KN-138**	*Race Specific/ **Chrome=KN-138C
1340	GSX1300R Hayabusa	16	SU-1308					
1340	GSX1300R Hayabusa	16	SU-1308R*					*Race Specific
1340	GSX1300R Hayabusa 50th Ann. Edition	14	SU-1308				KN-138*	*Chrome=KN-138C
1340	GSX1300R Hayabusa 50th Ann. Edition	14	SU-1308R*				KN-138**	*Race Specific/ **Chrome=KN-138C
1400	Boulevard S83	05-09	SU-1487				KN-138*	*Chrome=KN-138C
1400	GSX1400	01-07	SU-1402				KN-138*	*Chrome=KN-138C
1400	GV1400 Cavalcade	86					KN-134	
1400	GV1400 Cavalcade	87-89					KN-138*	*Chrome=KN-138C
1400	VS1400 Intruder	87-95	SU-1487				KN-138*	*Chrome=KN-138C
1400	VS1400GLP Intruder	96-04	SU-1487				KN-138*	*Chrome=KN-138C
1400	VS1400GLP Intruder	05-09					KN-138*	*Chrome=KN-138C
1462	Boulevard C90 BOSS	15					KN-138*	*Chrome=KN-138C
1462	Boulevard C90T	15					KN-138*	*Chrome=KN-138C
1462	Boulevard M90	15					KN-138*	*Chrome=KN-138C
1500	Boulevard C90	05-09	SU-1598				KN-138*	*Chrome=KN-138C
1500	Boulevard C90 Black	05-08	SU-1598				KN-138*	*Chrome=KN-138C
1500	Boulevard C90T	05-09	SU-1598				KN-138*	*Chrome=KN-138C
1500	Boulevard M90	09					KN-138*	*Chrome=KN-138C
1500	VL1500LC Intruder	98-05	SU-1598				KN-138*	*Chrome=KN-138C
1500	VL1500LC Intruder	06					KN-138*	*Chrome=KN-138C
1500	VL1500LC Intruder	07-08	SU-1598				KN-138*	*Chrome=KN-138C
1500	VL1500LC Intruder	09					KN-138*	*Chrome=KN-138C
1500	VZ1500 Boulevard	09					KN-138*	*Chrome=KN-138C
1500	VZ1500 Intruder M1500	09-10					KN-138*	*Chrome=KN-138C
1600	Boulevard M95	05	KA-1596				KN-204*	*Chrome=KN-204C
1600	VZ1600 Marauder	04-05	KA-1596				KN-204*	*Chrome=KN-204C
1773	Boulevard M109R	06-09	SU-1806				KN-138*	*Chrome=KN-138C
1773	Boulevard M109R	11	SU-1806				KN-138*	*Chrome=KN-138C
1773	Boulevard M109R2	08-09	SU-1806				KN-138*	*Chrome=KN-138C
1783	Boulevard M109R	12-14	SU-1806				KN-138*	*Chrome=KN-138C

2) Requires Two; 3) Requires Three; 4) Requires Four. The use of custom air filter requires removal of air box. Some custom filters and intakes are not legal for sale or use on any pollution controlled motor vehicle in California or states adopting California emission procedures. See knfilters.com for CARB status on each part for a specific vehicle.

# Motorcycle - Application Listing

CC	Model	Year	Air Filter	Air Filter Precharger	Custom	Custom Precharger	Oil Filter	Comments
<b>SUZUKI</b>								
1783	Boulevard M109R BOSS	14	SU-1806				KN-138*	*Chrome=KN-138C
1783	Boulevard M109R BOSS	15					KN-138*	*Chrome=KN-138C
1783	Boulevard M109RZ Limited	11	SU-1806				KN-138*	*Chrome=KN-138C
1783	Boulevard M109RZ Limited	14	SU-1806				KN-138*	*Chrome=KN-138C
1800	Boulevard C109R	08-09					KN-138*	*Chrome=KN-138C
1800	Boulevard C109RT	08-09					KN-138*	*Chrome=KN-138C
1800	Boulevard C109T	08					KN-138*	*Chrome=KN-138C
1800	VLR1800 C109 Boulevard	08-10					KN-138*	*Chrome=KN-138C
1800	VLR1800 C1800R Intruder	08-12	SU-1806*				KN-138**	*OEM 1378048G00/ **Chrome=KN-138C
1800	VLR1800 C1800RT Intruder	09	SU-1806*				KN-138**	*OEM 1378048G00/ **Chrome=KN-138C
1800	VLR1800 C1800RT Intruder	11	SU-1806*				KN-138**	*OEM 1378048G00/ **Chrome=KN-138C
1800	VZR1800 Intruder	06-10	SU-1806				KN-138*	*Chrome=KN-138C
<b>TRIUMPH</b>								
596	Speed Four	04	TB-6000				KN-191	
596	Speed Four	05-06	TB-6000				KN-204*	*Chrome=KN-204C
596	TT600	00-05	TB-6000				KN-191	
600	Daytona 600	03					KN-191	
600	Daytona 600	04	TB-6000				KN-204*	*Chrome=KN-204C
600	Speed Four	03	TB-6000				KN-191	
650	Daytona 650	05	TB-6000				KN-204*	*Chrome=KN-204C
671	Daytona 675	06-12	TB-6706				KN-204*	*Chrome=KN-204C
671	Daytona 675 SE	08-09	TB-6706				KN-204*	*Chrome=KN-204C
671	Daytona 675R	11-12	TB-6706				KN-204*	*Chrome=KN-204C
671	Street Triple	07	TB-6706					
671	Street Triple	08-10	TB-6706				KN-204*	*Chrome=KN-204C
671	Street Triple R	09-10	TB-6706				KN-204*	*Chrome=KN-204C
675	Daytona 675	13-14	TB-6713				KN-204*	*Chrome=KN-204C
675	Daytona 675 ABS	15					KN-204*	*Chrome=KN-204C
675	Daytona 675R	13-14	TB-6713				KN-204*	*Chrome=KN-204C
675	Daytona 675R ABS	15					KN-204*	*Chrome=KN-204C
675	Street Triple	11-12	TB-6706				KN-204*	*Chrome=KN-204C
675	Street Triple	13	TB-6713				KN-204*	*Chrome=KN-204C
675	Street Triple ABS	14	TB-6713				KN-204*	*Chrome=KN-204C
675	Street Triple ABS	15	TB-6713					
675	Street Triple R	11-12	TB-6706				KN-204*	*Chrome=KN-204C
675	Street Triple R	13	TB-6713				KN-204*	*Chrome=KN-204C
675	Street Triple R ABS	14	TB-6713				KN-204*	*Chrome=KN-204C
675	Street Triple R ABS	15	TB-6713					
749	Trident 750	93-97	TB-9091				KN-192	
749	Trident 750	98					KN-192	
750	Daytona 750	91-95	TB-9091				KN-192	
750	Speed Triple 750	97					KN-192	
750	Trident 750	91					KN-192	
750	Trident 750	92	TB-9091				KN-192	
799	Tiger 800	11	TB-8011				KN-204*	*Chrome=KN-204C
799	Tiger 800 ABS	11-14	TB-8011				KN-204*	*Chrome=KN-204C
799	Tiger 800 XC	11	TB-8011				KN-204*	*Chrome=KN-204C
799	Tiger 800 XC	14-15	TB-8011				KN-204*	*Chrome=KN-204C
799	Tiger 800 XC	16	TB-8011					
799	Tiger 800 XC ABS	11-13	TB-8011				KN-204*	*Chrome=KN-204C
799	Tiger 800 XC ABS	15	TB-8011				KN-204*	*Chrome=KN-204C
799	Tiger 800 XC ABS	16	TB-8011					
799	Tiger 800 XCca	16	TB-8011					
799	Tiger 800 XCx	15	TB-8011				KN-204*	*Chrome=KN-204C
799	Tiger 800 XCx	16	TB-8011					

2) Requires Two; 3) Requires Three; 4) Requires Four. The use of custom air filter requires removal of air box. Some custom filters and intakes are not legal for sale or use on any pollution controlled motor vehicle in California or states adopting California emission procedures. See knfilters.com for CARB status on each part for a specific vehicle.

# Motorcycle - Application Listing

CC	Model	Year	Air Filter	Air Filter Precharger	Custom	Custom Precharger	Oil Filter	Comments
<b>TRIUMPH</b>								
799	Tiger 800 XR	15	TB-8011				KN-204*	*Chrome=KN-204C
799	Tiger 800 XR	16	TB-8011					
799	Tiger 800 XRt	16	TB-8011					
799	Tiger 800 XRx	15	TB-8011				KN-204*	*Chrome=KN-204C
799	Tiger 800 XRx	16	TB-8011					
800	Bonneville	01-04	TB-9004				KN-191	
800	Bonneville	05	TB-9004				KN-204*	*Chrome=KN-204C
800	Bonneville T100	02-04	TB-9004				KN-191	
865	America	02					KN-191	
865	America	03	TB-8002				KN-191	
865	America	04-15	TB-8002				KN-204*	*Chrome=KN-204C
865	America Classic	11	TB-8002				KN-204*	*Chrome=KN-204C
865	America LT	14	TB-8002				KN-204*	*Chrome=KN-204C
865	America LT	15					KN-204*	*Chrome=KN-204C
865	Bonneville	06-15	TB-9004				KN-204*	*Chrome=KN-204C
865	Bonneville Newchurch SE	14	TB-9004				KN-204*	*Chrome=KN-204C
865	Bonneville SE	09-13	TB-9004				KN-204*	*Chrome=KN-204C
865	Bonneville T100	05-15	TB-9004				KN-204*	*Chrome=KN-204C
865	Bonneville T100 Black	14-15	TB-9004				KN-204*	*Chrome=KN-204C
865	Bonneville T214 SE	15					KN-204*	*Chrome=KN-204C
865	Scrambler	06-15	TB-9004				KN-204*	*Chrome=KN-204C
865	Speedmaster	03-14	TB-8002				KN-204*	*Chrome=KN-204C
865	Speedmaster	15					KN-204*	*Chrome=KN-204C
865	Thruxton	04-15	TB-9004				KN-204*	*Chrome=KN-204C
865	Thruxton Ace SE	15	TB-9004				KN-204*	*Chrome=KN-204C
865	Thruxton SE	11	TB-9004				KN-204*	*Chrome=KN-204C
885	Adventurer 900	95					KN-192	
885	Adventurer 900	96-98	TB-9095				KN-192	
885	Adventurer 900	99-00	TB-9095				KN-204*	*Chrome=KN-204C
885	Adventurer 900	01	TB-9095				KN-192	
885	Daytona 900	94-96	TB-9091				KN-192	
885	Daytona 900	97					KN-192	
885	Legend TT	99-00	TB-9095				KN-204*	*Chrome=KN-204C
885	Legend TT	01	TB-9095				KN-192	
885	Speed Triple	94-96	TB-9091				KN-192	
885	Speed Triple	97	TB-9091					
885	Speed Triple T509	97-98	TB-9097				KN-191	
885	Sprint	95-98	TB-9091				KN-192	
885	Tiger	92-98	TB-9091				KN-192	
885	Tiger	99-00	TB-9097				KN-204*	*Chrome=KN-204C
885	Trident 900	91-98	TB-9091				KN-192	
885	Trophy 900	92-98	TB-9091				KN-192	
885	Trophy 900	99-00	TB-9091				KN-204*	*Chrome=KN-204C
885	Trophy 900	01	TB-9091				KN-192	
900	Daytona Super III	94-97	TB-9091				KN-192	
900	Sprint Sport	95-98					KN-401	
900	Tiger	91	TB-9091				KN-192	
900	Trophy 900	91	TB-9091				KN-192	
955	Daytona 955i	06	TB-9002				KN-204*	*Chrome=KN-204C
955	Daytona T595	97-98	TB-9097				KN-191	
955	Daytona T595	99-00	TB-9097					
955	Speed Triple 955i	05					KN-204*	*Chrome=KN-204C
955	Speed Triple T509	99-01	TB-9097					
955	Speed Triple T509	02	TB-9002					
955	Sprint ST	99-00	TB-9097					
955	Sprint ST	01	TB-9097				KN-204*	*Chrome=KN-204C
955	Sprint ST	02-04	TB-9002				KN-204*	*Chrome=KN-204C

2) Requires Two; 3) Requires Three; 4) Requires Four. The use of custom air filter requires removal of air box. Some custom filters and intakes are not legal for sale or use on any pollution controlled motor vehicle in California or states adopting California emission procedures. See knfilters.com for CARB status on each part for a specific vehicle.

# Motorcycle - Application Listing

CC	Model	Year	Air Filter	Air Filter Precharger	Custom	Custom Precharger	Oil Filter	Comments
<b>TRIUMPH</b>								
956	Daytona 955i	99-00	TB-9097				KN-191	
956	Daytona 955i	01	TB-9097				KN-204*	*Chrome=KN-204C
956	Daytona 955i	02-05	TB-9002				KN-204*	*Chrome=KN-204C
956	Daytona 955i CE	02	TB-9002				KN-204*	*Chrome=KN-204C
956	Speed Triple	98	TB-9091					
956	Speed Triple	99-00	TB-9097				KN-191	
956	Speed Triple	01	TB-9097				KN-204*	*Chrome=KN-204C
956	Speed Triple	02-04	TB-9002				KN-204*	*Chrome=KN-204C
956	Sprint RS	99-00	TB-9097					
956	Sprint RS	01	TB-9097				KN-204*	*Chrome=KN-204C
956	Sprint RS	02-04	TB-9002				KN-204*	*Chrome=KN-204C
956	Tiger	01-06	TB-9097				KN-204*	*Chrome=KN-204C
1000	Daytona 1000	91-95	TB-9091				KN-192	
1050	Speed Triple	05-10	TB-1005				KN-204*	*Chrome=KN-204C
1050	Speed Triple	11-12	TB-1011				KN-204*	*Chrome=KN-204C
1050	Speed Triple ABS	11-14	TB-1011				KN-204*	*Chrome=KN-204C
1050	Speed Triple ABS	15					KN-204*	*Chrome=KN-204C
1050	Speed Triple R ABS	12-14	TB-1011				KN-204*	*Chrome=KN-204C
1050	Speed Triple R ABS	15					KN-204*	*Chrome=KN-204C
1050	Speed Triple SE	13-14	TB-1011				KN-204*	*Chrome=KN-204C
1050	Sprint GT	11-12	TB-1005				KN-204*	*Chrome=KN-204C
1050	Sprint GT	13					KN-204*	*Chrome=KN-204C
1050	Sprint ST	05-11	TB-1005				KN-204*	*Chrome=KN-204C
1050	Tiger	07-11	TB-1005				KN-204*	*Chrome=KN-204C
1050	Tiger 1050	13	TB-1005				KN-204*	*Chrome=KN-204C
1050	Tiger 1050 ABS	10-11	TB-1005				KN-204*	*Chrome=KN-204C
1050	Tiger 1050 ABS SE	12	TB-1005				KN-204*	*Chrome=KN-204C
1050	Tiger 1050 SE	10-11	TB-1005				KN-204*	*Chrome=KN-204C
1050	Tiger 1050 SE	13	TB-1005				KN-204*	*Chrome=KN-204C
1050	Tiger Sport 1050	13	TB-1005				KN-204*	*Chrome=KN-204C
1179	Daytona 1200	93-97	TB-9091				KN-192	
1179	Trophy 1200	92-03	TB-9091				KN-192	
1200	Trophy 1200	91	TB-9091				KN-192	
1215	Tiger Explorer	12-14	TB-1212				KN-204*	*Chrome=KN-204C
1215	Tiger Explorer ABS	15	TB-1212				KN-204*	*Chrome=KN-204C
1215	Tiger Explorer XC	13-14	TB-1212				KN-204*	*Chrome=KN-204C
1215	Tiger Explorer XC ABS	15	TB-1212				KN-204*	*Chrome=KN-204C
1215	Trophy SE	13-15	TB-1213				KN-204*	*Chrome=KN-204C
2294	Rocket III	04-10	TB-2204				KN-204*	*Chrome=KN-204C
2294	Rocket III Classic	06-10	TB-2204				KN-204*	*Chrome=KN-204C
2294	Rocket III Classic Tourer	07-11	TB-2204				KN-204*	*Chrome=KN-204C
2294	Rocket III Roadster	10-14	TB-2204				KN-204*	*Chrome=KN-204C
2294	Rocket III Roadster ABS	15	TB-2204				KN-204*	*Chrome=KN-204C
2294	Rocket III Touring	12-14	TB-2204				KN-204*	*Chrome=KN-204C
2294	Rocket III Touring ABS	15					KN-204*	*Chrome=KN-204C
<b>YAMAHA</b>								
49	YSR50	90				YA-0587		
50	YSR50	87-89				YA-0587		
50	YSR50	91-92				YA-0587		
80	PW80	83-08	YA-8083					
80	YZ80	93-01	YA-8096	22-8088PK				
85	YZ85	03-16	YA-8502					
90	TTR90	00-04	YA-9001					
90	TTR90E	03-07	YA-9001					
100	RS100	02-03	YA-0102					
124	TTR125LE	11-16	YA-1201					
124	XT125	90-91					KN-143	

2) Requires Two; 3) Requires Three; 4) Requires Four. The use of custom air filter requires removal of air box. Some custom filters and intakes are not legal for sale or use on any pollution controlled motor vehicle in California or states adopting California emission procedures. See knfilters.com for CARB status on each part for a specific vehicle.

# Motorcycle - Application Listing

CC	Model	Year	Air Filter	Air Filter Precharger	Custom	Custom Precharger	Oil Filter	Comments
<b>YAMAHA</b>								
124	YBR125	05-15	YA-1213					
124	YBR125 Custom	08-15	YA-1213					
125	MT125	15	YA-1208					
125	SR125	00-02					KN-143	
125	SR125SE	80-99					KN-143	
125	TTR125	00-04	YA-1201					
125	TTR125E	03-09	YA-1201					
125	TTR125L	00-09	YA-1201					
125	TTR125L	11	YA-1201					
125	TTR125LE	03-09	YA-1201					
125	TTR125LW	07	YA-1201					
125	TW125	99-04					KN-143	
125	WR125R	09-15	YA-1208				KN-141	
125	WR125X	09-15	YA-1208				KN-141	
125	XT125	82-89					KN-143	
125	XT125	92-96					KN-143	
125	XV125S Virago	97-01					KN-145	
125	XVS125 DragStar	00-04					KN-145	
125	YZ125	91-92	YA-2506XD	YA-4098-1DK				
125	YZ125	97-16	YA-2506XD	YA-4098-1DK				
125	YZF R125	08-15	YA-1208				KN-141	
150	YZF R15	08-10	YA-1208					
150	YZF R15	11	YA-1208*					*to 9/11
153	FZ150 Fazer	09-11	YA-1611					
153	FZ16	08-11	YA-1611					
194	AG200	90-92					KN-143	
196	BW200	85-88					KN-143	
200	TW200	87-16	YA-2002				KN-143	
223	TTR230	05-16	YA-2305				KN-143	
225	TT225	86-87	YA-2292				KN-143	
225	TTR225	00-04	YA-2292				KN-143	
225	XT225	01-07	YA-2292				KN-143	
225	XT225 Serow	92-00	YA-2292				KN-143	
246	FZR250	93-94					KN-303*	*Chrome=KN-303C
247	XT250	90-92					KN-145	
250	FZR250	89-90					KN-145*	*EXUP, MK1, MK2
250	FZR250	91-92					KN-303*	*Chrome=KN-303C
250	FZR250 Genesis	89					KN-145	
250	SRX250	87					KN-143	
250	TTR250	00-06	YA-3586				KN-142	
250	WR250F	01-02	YA-2506XD	YA-4098-1DK			KN-142	
250	WR250F	03-08	YA-4503	YA-4503DK			KN-141	
250	WR250F	09	YA-4503	YA-4503DK			KN-140	
250	WR250F	11-13	YA-4503	YA-4503DK			KN-140	
250	WR250F	15-16	YA-4514XD	YA-4514DK			KN-140	
250	WR250R	07-08	YA-3586				KN-141	
250	WR250R	09-16	YA-3586				KN-140	
250	WR250X	07-08	YA-3586				KN-141	
250	WR250X	09-12	YA-3586				KN-140	
250	WR250X	13-15	YA-3586				KN-140	
250	XT250	80-89					KN-145	
250	XT250	06					KN-141	
250	XT250	08	YA-2509				KN-141	
250	XT250	09-16	YA-2509				KN-140	
250	XT250X	06					KN-141	
250	XT250X	08	YA-2509				KN-141	
250	XV250	88-95					KN-145	

2) Requires Two; 3) Requires Three; 4) Requires Four. The use of custom air filter requires removal of air box. Some custom filters and intakes are not legal for sale or use on any pollution controlled motor vehicle in California or states adopting California emission procedures. See knfilters.com for CARB status on each part for a specific vehicle.

# Motorcycle - Application Listing

CC	Model	Year	Air Filter	Air Filter Precharger	Custom	Custom Precharger	Oil Filter	Comments
<b>YAMAHA</b>								
250	XV250 Route 66	88-90	YA-2588				KN-145	
250	XV250 Route 66	95-97					KN-145	
250	XV250 Virago	91-94	YA-2588					
250	XV250 Virago	95-07	YA-2588				KN-145	
250	XV250 Virago	08-09					KN-145	
250	XV250 V-Star	08-16	YA-2588				KN-145	
250	XV250S Virago	95-06					KN-145	
250	XVS250 DragStar	01-07					KN-145	
250	YBR250	08-12					KN-140	
250	YZ250	91-92	YA-2506XD	YA-4098-1DK				
250	YZ250	97-02	YA-2506XD	YA-4098-1DK				
250	YZ250	03-08	YA-2506XD	YA-4098-1DK			KN-141	
250	YZ250	09-16	YA-2506XD	YA-4098-1DK				
250	YZ250F	01-02	YA-2506XD	YA-4098-1DK			KN-142	
250	YZ250F	03-08	YA-2506XD	YA-4098-1DK			KN-141	
250	YZ250F	09-13	YA-2506XD	YA-4098-1DK			KN-140	
250	YZ250F	14-16	YA-4514XD	YA-4514DK			KN-140	
250	YZ250FX	15	YA-4514XD	YA-4514DK			KN-140	
250	YZ250X	16	YA-2506XD	YA-4098-1DK				
321	YZF R3	15	YA-3215				KN-204*	*Chrome=KN-204C
343	TT350	90					KN-143	
350	TT350	86-87	YA-3586				KN-143	
350	TT350	88-89					KN-143	
350	TT350	91-92					KN-143	
350	XT350	85-01					KN-143	
394	FZ400	97-00					KN-144	
394	FZR400	90	YA-4085		RC-1824*	RC-1820DK <sup>4</sup>	KN-144	*Inc. 4 Filters
394	XJR400	92-94					KN-303*	*Chrome=KN-303C
399	YZ400F	98	YA-2506XD	YA-4098-1DK			KN-142	
400	FZR400	88-89	YA-4085		RC-1824*	RC-1820DK <sup>4</sup>	KN-144	*Inc. 4 Filters
400	FZR400R	87					KN-144	
400	FZR400RR EXUP	90-94					KN-303*	*Chrome=KN-303C
400	SR400	92-08	YA-4092				KN-145	
400	SR400	14	YA-5008					
400	SR400	15-16	YA-5008				KN-145	
400	WR400F	98-02	YA-2506XD	YA-4098-1DK			KN-142	
400	XJR400	95-97					KN-303*	*Chrome=KN-303C
400	XJR400R	98-07					KN-303*	*Chrome=KN-303C
400	XVS400 DragStar	96-07	YA-6598				KN-145	
400	YZ400F	99	YA-2506XD	YA-4098-1DK			KN-142	
426	WR426F	01-02	YA-2506XD	YA-4098-1DK			KN-142	
426	YZ426F	00-02	YA-2506XD	YA-4098-1DK			KN-142	
450	WR450F	03-08	YA-4503	YA-4503DK			KN-141	
450	WR450F	09	YA-4503	YA-4503DK			KN-140	
450	WR450F	11-15	YA-4503	YA-4503DK			KN-140	
450	WR450F	16					KN-140	
450	YZ450F	03-08	YA-2506XD	YA-4098-1DK			KN-141	
450	YZ450F	09	YA-2506XD	YA-4098-1DK			KN-140	
450	YZ450F	10-13	YA-4510	YA-4510DK			KN-140	
450	YZ450F	14-16	YA-4514XD	YA-4514DK			KN-140	
500	SR500	82-00					KN-145	
535	XV535 Virago	87-02					KN-145	
581	XJ600 Seca II	95-99	YA-6092		RC-1824*	RC-1820DK <sup>4</sup>	KN-303**	*Inc. 4 Filters/ **Chrome=KN-303C
592	YX600 Radian	90	YA-1600		RC-1824*	RC-1820DK <sup>4</sup>	KN-144	*Inc. 4 Filters
595	TT600	90					KN-145	
599	YZF R6	99-05	YA-6001				KN-303*	*Chrome=KN-303C
599	YZF R6	06-07	YA-6006				KN-204*	*Chrome=KN-204C

2) Requires Two; 3) Requires Three; 4) Requires Four. The use of custom air filter requires removal of air box. Some custom filters and intakes are not legal for sale or use on any pollution controlled motor vehicle in California or states adopting California emission procedures. See knfilters.com for CARB status on each part for a specific vehicle.

# Motorcycle - Application Listing

CC	Model	Year	Air Filter	Air Filter Precharger	Custom	Custom Precharger	Oil Filter	Comments
<b>YAMAHA</b>								
599	YZF R6	08-16	YA-6008				KN-204*	*Chrome=KN-204C
599	YZF R6	08-16	YA-6008R*				KN-204**	*Race Specific/ **Chrome=KN-204C
599	YZF R6S	06-09	YA-6001				KN-303*	*Chrome=KN-303C
599	YZF R6S	10	YA-6008				KN-303*	*Chrome=KN-303C
599	YZF R6S	10	YA-6008R*				KN-303**	*Race Specific/ **Chrome=KN-303C
600	FJ600	84-86	YA-1684		RC-1824*	RC-1820DK <sup>4</sup>	KN-144	*Inc. 4 Filters
600	FJ600	90-93	YA-1684		RC-1824*	RC-1820DK <sup>4</sup>	KN-144	*Inc. 4 Filters
600	FZ6	04-06	YA-6004				KN-303*	*Chrome=KN-303C
600	FZ6	07-09	YA-6004				KN-204*	*Chrome=KN-204C
600	FZ6 Fazer	04-06	YA-6004				KN-303*	*Chrome=KN-303C
600	FZ6 Fazer	07	YA-6004				KN-204*	*Chrome=KN-204C
600	FZ6 Fazer S2	07-09	YA-6004				KN-204*	*Chrome=KN-204C
600	FZ6 S2	07-09	YA-6004				KN-204*	*Chrome=KN-204C
600	FZ600	86-88	YA-1686		RC-1824*	RC-1820DK <sup>4</sup>	KN-144	*Inc. 4 Filters
600	FZ600	89					KN-144	
600	FZ6N	08	YA-6004				KN-204*	*Chrome=KN-204C
600	FZ6R	09-16	YA-6009				KN-204*	*Chrome=KN-204C
600	FZ6S	08	YA-6004				KN-204*	*Chrome=KN-204C
600	FZR600	89-90	YA-6089		RU-2852*		KN-144	*Inc. 2 Filters
600	FZR600	91-93	YA-6089		RU-2852*		KN-303**	*Inc. 2 Filters/ **Chrome=KN-303C
600	FZR600R	90	YA-6089		RU-2852*		KN-144	*Inc. 2 Filters
600	FZR600R	91-93	YA-6089		RU-2852*		KN-303**	*Inc. 2 Filters/ **Chrome=KN-303C
600	FZR600R	94-95	YA-6089*		RU-2852**		KN-303***	*US/ **US, Inc. 2 Filters/ ***Chrome=KN-303C
600	FZR600R	96-99	YA-6089		RU-2852*		KN-303**	*Inc. 2 Filters/ **Chrome=KN-303C
600	FZS600 Fazer	98-03	YA-6098				KN-147	
600	SRX600	86	YA-6050		RC-1820*	RC-1820DK	KN-145	*Req Both Filters, 2 Inch. Flange
600	SRX600	86	YA-6050		RC-2450*	RC-1820DK	KN-145	*Req Both Filters, 1-3/4 Inch. Flange
600	SRX600	87-89					KN-145	
600	TT600	83-89	YA-6003				KN-145	
600	TT600	91-92					KN-145	
600	TT600	97					KN-143	
600	TT600E	99-00					KN-143	
600	TT600R	97-00					KN-143	
600	TT600R	01-03					KN-145	
600	TT600RE	04					KN-145	
600	XJ6	09-14	YA-6009				KN-204*	*Chrome=KN-204C
600	XJ6	15	YA-6009					
600	XJ6 Diversion	09-14	YA-6009				KN-204*	*Chrome=KN-204C
600	XJ6 Diversion	15	YA-6009					
600	XJ600	84-86	YA-1684		RC-1824*	RC-1820DK <sup>4</sup>	KN-144	*Inc. 4 Filters
600	XJ600	87-89					KN-144	
600	XJ600	90-93	YA-1684		RC-1824*	RC-1820DK <sup>4</sup>	KN-144	*Inc. 4 Filters
600	XJ600	92	YA-1684		RC-1824*	RC-1820DK <sup>4</sup>	KN-303**	*Inc. 4 Filters/ **Chrome=KN-303C
600	XJ600 Diversion	92-03	YA-6092		RC-1824*	RC-1820DK <sup>4</sup>	KN-303**	*Inc. 4 Filters/ **Chrome=KN-303C
600	XJ600 Seca II	92-94	YA-6092		RC-1824*	RC-1820DK <sup>4</sup>	KN-303**	*Inc. 4 Filters/ **Chrome=KN-303C
600	XJ600N Diversion	97-03					KN-303*	*Chrome=KN-303C
600	XS600	92					KN-303*	*Chrome=KN-303C
600	XS600	95					KN-303*	*Chrome=KN-303C
600	XT600	84-89	YA-6084				KN-145	

2) Requires Two; 3) Requires Three; 4) Requires Four. The use of custom air filter requires removal of air box. Some custom filters and intakes are not legal for sale or use on any pollution controlled motor vehicle in California or states adopting California emission procedures. See knfilters.com for CARB status on each part for a specific vehicle.

# Motorcycle - Application Listing

CC	Model	Year	Air Filter	Air Filter Precharger	Custom	Custom Precharger	Oil Filter	Comments
<b>YAMAHA</b>								
600	XT600	90	YA-6090				KN-145	
600	XT600	91-95					KN-145	
600	XT600 Tenere	83-87					KN-145	
600	XT600E	91-99	YA-6090				KN-145	
600	XT600E	00-03					KN-145	
600	XT600Z Tenere	88-89					KN-145	
600	XT600Z Tenere	91					KN-145	
600	YX600 Radian	86-89	YA-1600		RC-1824*	RC-1820DK <sup>4</sup>	KN-144	*Inc. 4 Filters
600	YX600 Radian	91	YA-1600				KN-144	
600	YZF R46	05					KN-303*	*Chrome=KN-303C
600	YZF600R	94-95	YA-6094				KN-303*	*Chrome=KN-303C
600	YZF600R	96-07	YA-6096				KN-303*	*Chrome=KN-303C
608	SRX600	90-94					KN-145	
650	XVS650 DragStar	96-02	YA-6598		RC-1090	22-8028PK	KN-145	
650	XVS650 DragStar	03-04	YA-6598				KN-145	
650	XVS650 V-Star	13-16	YA-6598				KN-145	
650	XVS650 V-Star Classic	98-10	YA-6598				KN-145	
650	XVS650 V-Star Custom	98-11	YA-6598				KN-145	
650	XVS650 V-Star Silverado	02-11	YA-6598				KN-145	
650	XVS650A DragStar Classic	98-06	YA-6598				KN-145	
660	MT03	06-11	YA-6604				KN-145	
660	SZR660	96-97	YA-0086		RC-1820*	RC-1820DK	KN-145	*Req Both Filters
660	SZR660	96-97	YA-0086		RC-2450*	RC-1820DK	KN-145	*Req Both Filters
660	SZR660	98	YA-0086				KN-145	
660	XT660	08	YA-6604				KN-145	
660	XT660R	04-14	YA-6604				KN-145	
660	XT660R	15	YA-6604				KN-145	
660	XT660X	10-11	YA-6604				KN-145	
660	XT660X	12-15	YA-6604				KN-145	
660	XT660X Super Motard	04-10	YA-6604				KN-145	
660	XT660Z Tenere	08-13	YA-6608				KN-145	
660	XT660Z Tenere	14	YA-6608				KN-145	
660	XTZ660 Tenere	91-92					KN-145	
660	XTZ660 Tenere	93-98	YA-6090				KN-145	
660	XTZ660 Tenere	99					KN-145	
689	FZ-07	15-16	YA-6814				KN-204*	*Chrome=KN-204C
689	MT-07	14	YA-6814				KN-204*	*Chrome=KN-204C
689	MT-07	15-16	YA-6814				KN-204*	*Chrome=KN-204C
689	XSR700	16	YA-6814				KN-145	
700	FZ700 Genesis	86-87	YA-7585		RU-2754*		KN-144	*Inc. 4 Filters
700	FZX700 Fazer	86-87	YA-7086		RC-1824*	RC-1820DK <sup>4</sup>	KN-401	*Inc. 4 Filters
700	XJ700 Maxim	85-86	YA-7080		RC-1824*	RC-1820DK <sup>4</sup>	KN-144	*Inc. 4 Filters
700	XJ700X Maxim X	85-86	YA-7080		RC-1824*	RC-1820DK <sup>4</sup>	KN-144	*Inc. 4 Filters
700	XV700 Virago	84-87	YA-1186				KN-145	
741	FZ750 Genesis	90					KN-401	
741	YZF750 SP	93-98	YA-7593				KN-303*	*Chrome=KN-303C
741	YZF750R	93					KN-303*	*Chrome=KN-303C
741	YZF750R	94-98	YA-7593		RU-3092*		KN-303**	*Inc. 2 Filters/ **Chrome=KN-303C
747	XV750 Virago	90-97	YA-1186				KN-145	
747	XV750 Virago	98-99					KN-145	
750	FZ750	85-86	YA-7585		RU-2754*		KN-401	*Inc. 4 Filters
750	FZ750	87					KN-401	
750	FZ750	88	YA-7585		RU-2754*		KN-401	*Inc. 4 Filters
750	FZ750 Genesis	87-89					KN-401	
750	FZ750 Genesis	91-94					KN-401	
750	FZR750	87-88	YA-7585		RU-2754*		KN-401	*Inc. 4 Filters
750	FZR750R	87-88	YA-7585		RU-2754*		KN-401	*Inc. 4 Filters

2) Requires Two; 3) Requires Three; 4) Requires Four. The use of custom air filter requires removal of air box. Some custom filters and intakes are not legal for sale or use on any pollution controlled motor vehicle in California or states adopting California emission procedures. See knfilters.com for CARB status on each part for a specific vehicle.



# Motorcycle - Application Listing

CC	Model	Year	Air Filter	Air Filter Precharger	Custom	Custom Precharger	Oil Filter	Comments
<b>YAMAHA</b>								
750	FZR750R	89-92					KN-401	
750	FZR750R - OWO1	87-88			RU-2922*		KN-401	*Inc. 2 Filters
750	FZR750R - OWO1	89					KN-401	
750	FZR750R - OWO1	90-92					KN-303*	*Chrome=KN-303C
750	FZX750	98					KN-401	
750	FZX750 Fazer	86-90					KN-401	
750	XJ750X Maxim X	85-86	YA-7080		RC-1824*	RC-1820DK <sup>4</sup>	KN-144	*Inc. 4 Filters
750	XV750 Virago	88-89	YA-1186				KN-145	
750	YZF R7	99-01					KN-303*	*Chrome=KN-303C
754	XTZ750 Super Tenere	89-97	YA-0075 <sup>2</sup>				KN-145	
800	FZ8	10-14	YA-1006				KN-204*	*Chrome=KN-204C
800	FZ8	15	YA-1006					
847	FJ-09	15-16	YA-8514				KN-204*	*Chrome=KN-204C
847	FZ-09	14-16	YA-8514				KN-204*	*Chrome=KN-204C
847	MT09	14-16	YA-8514					
850	TDM850	91					KN-145	
850	TDM850	92-96	YA-7585		RU-2780	RU-2780DK	KN-145	
850	TDM850	97-98	YA-7585		RU-0810	25-1770	KN-145	
850	TDM850	97-98	YA-7585		RU-0810	RU-0510PK	KN-145	
850	TDM850	97-98	YA-7585		RU-0810	RU-0510PL	KN-145	
850	TDM850	97-98	YA-7585		RU-0810	RU-0510PR	KN-145	
850	TDM850	97-98	YA-7585		RU-0810	RU-0510PY	KN-145	
850	TDM850	99-02	YA-7585				KN-145	
850	TRX850	96-99	YA-8596				KN-145	
850	TRX850	00					KN-145	
897	TDM900	02-14	YA-9002				KN-145	
897	TDM900A	07-14	YA-9002				KN-145	
900	XJ900F	84-90					KN-144	
900	XJ900S Diversion	98-00					KN-303*	*Chrome=KN-303C
900	XJ900S Diversion	01	YA-7585				KN-303*	*Chrome=KN-303C
900	XJ900S Diversion	02-03					KN-303*	*Chrome=KN-303C
903	XJ900F	91	YA-9083		RC-1824*	RC-1820DK <sup>4</sup>	KN-144	*Inc. 4 Filters
903	XJ900F	92-93	YA-9083				KN-144	
903	XJ900S Diversion	94-97					KN-303*	*Chrome=KN-303C
920	XV920 Virago	81-86	YA-1550				KN-145	
942	XV950	14	YA-9514					
942	XV950	15	YA-9514				KN-204*	*Chrome=KN-204C
942	XV950	16	YA-9514					
942	XV950R	14	YA-9514					
942	XV950R	15	YA-9514				KN-204*	*Chrome=KN-204C
942	XV950R	16	YA-9514					
942	XVS950 Bolt	14-16	YA-9514		RK-3940		KN-204*	*Chrome=KN-204C
942	XVS950 Bolt C-Spec	15	YA-9514				KN-204*	*Chrome=KN-204C
942	XVS950 Bolt C-Spec	16	YA-9514		RK-3940		KN-204*	*Chrome=KN-204C
942	XVS950 Bolt R-Spec	14-16	YA-9514		RK-3940		KN-204*	*Chrome=KN-204C
942	XVS950 Midnight Star	09-13	YA-1307				KN-204*	*Chrome=KN-204C
942	XVS950 V-Star	09-16	YA-1307				KN-204*	*Chrome=KN-204C
942	XVS950 V-Star Tourer	09-15	YA-1307				KN-204*	*Chrome=KN-204C
990	FZR1000	90	YA-1089		RU-3092*		KN-401	*Inc. 2 Filters
990	FZR1000	91-95	YA-1089		RU-3092*		KN-303**	*Inc. 2 Filters/ **Chrome=KN-303C
990	GTS1000	93-97					KN-303*	*Chrome=KN-303C
998	FZ1 Fazer	06-13	YA-1006				KN-204*	*Chrome=KN-204C
998	FZ1 Fazer	14-15	YA-1006					
998	YZF R1	98-01	YA-1098				KN-303*	*Chrome=KN-303C
998	YZF R1	02-03	YA-1002				KN-303*	*Chrome=KN-303C
998	YZF R1	04-06	YA-1004				KN-303*	*Chrome=KN-303C
998	YZF R1	07-08	YA-1007				KN-204*	*Chrome=KN-204C

2) Requires Two; 3) Requires Three; 4) Requires Four. The use of custom air filter requires removal of air box. Some custom filters and intakes are not legal for sale or use on any pollution controlled motor vehicle in California or states adopting California emission procedures. See knfilters.com for CARB status on each part for a specific vehicle.

# Motorcycle - Application Listing

CC	Model	Year	Air Filter	Air Filter Precharger	Custom	Custom Precharger	Oil Filter	Comments
<b>YAMAHA</b>								
998	YZF R1	09-14	YA-1009				KN-204*	*Chrome=KN-204C
998	YZF R1	09-14	YA-1009R*				KN-204**	*Race Specific/ **Chrome=KN-204C
998	YZF R1	15					KN-204*	*Chrome=KN-204C
998	YZF R1 LE	06	YA-1004				KN-303*	*Chrome=KN-303C
998	YZF R1 LE	10	YA-1009				KN-204*	*Chrome=KN-204C
998	YZF R1 LE	10	YA-1009R*				KN-204**	*Race Specific/ **Chrome=KN-204C
998	YZF R1 SP	06	YA-1004				KN-303*	*Chrome=KN-303C
998	YZF R1M	15					KN-204*	*Chrome=KN-204C
998	YZF R1S	16					KN-204*	*Chrome=KN-204C
1000	FZ1	01-05	YA-1001				KN-303*	*Chrome=KN-303C
1000	FZ1	06-15	YA-1006				KN-204*	*Chrome=KN-204C
1000	FZ1N	06	YA-1006				KN-204*	*Chrome=KN-204C
1000	FZ1N	08	YA-1006				KN-204*	*Chrome=KN-204C
1000	FZ1S	06	YA-1006				KN-204*	*Chrome=KN-204C
1000	FZ1S	08	YA-1006				KN-204*	*Chrome=KN-204C
1000	FZR1000	87-88	YA-7585		RC-2814*		KN-401	*Inc. 4 Filters
1000	FZR1000	89	YA-1089		RU-3092*		KN-401	*Inc. 2 Filters
1000	FZS1000 Fazer	01-05	YA-1001				KN-303*	*Chrome=KN-303C
1000	GTS1000	98-00					KN-303*	*Chrome=KN-303C
1000	MT01	10-11	YA-1605				KN-303*	*Chrome=KN-303C
1000	XV1000 SE	88-89					KN-145	
1000	YZF1000R	97	YA-1089		RU-3092*		KN-303**	*Inc. 2 Filters/ **Chrome=KN-303C
1063	BT1100 Bulldog	02-06	YA-7585				KN-145	
1100	FJ1100	86					KN-401	
1100	XV1100 Virago	86-99	YA-1186				KN-145	
1100	XV1100 Virago	00					KN-145	
1100	XVS1100 DragStar	99-04	YA-1199				KN-145	
1100	XVS1100 DragStar	05					KN-145	
1100	XVS1100 V-Star	99	YA-1199				KN-145	
1100	XVS1100 V-Star Classic	99					KN-145	
1100	XVS1100 V-Star Classic	00-09	YA-1199				KN-145	
1100	XVS1100 V-Star Custom	00-09	YA-1199				KN-145	
1100	XVS1100 V-Star Silverado	02-09	YA-1199				KN-145	
1100	XVS1100A DragStar Classic	99-07	YA-1199				KN-145	
1173	FJ1200	90-93	YA-1184		RC-2814*		KN-401	*Inc. 4 Filters
1173	FJ1200	94-95					KN-401	
1173	XJR1200	95	YA-1295		RC-0984*	RC-1820DK <sup>4</sup>	KN-401	*Inc. 4 Filters
1173	XJR1200	96	YA-1295				KN-401	
1173	XJR1200	97-99	YA-1295		RC-0984*	RC-1820DK <sup>4</sup>	KN-401	*Inc. 4 Filters
1173	XJR1200	00	YA-1295				KN-401	
1199	XTZ1200 Super Tenere	10-16	YA-1210				KN-204*	*Chrome=KN-204C
1199	XTZ1200 Super Tenere ES	14-16	YA-1210				KN-204*	*Chrome=KN-204C
1200	FJ1200	86-89	YA-1184		RC-2814*		KN-401	*Inc. 4 Filters
1200	VMX1200 V-Max	85-95	YA-1285		RU-2989*		KN-146	*Jet kit required, purchase separately
1200	VMX1200 V-Max	96-07	YA-1285		RU-2989*		KN-303**	*Jet kit required, purchase separately/ **Chrome=KN-303C
1200	XJR1200	01	YA-1295				KN-401	
1200	XVZ1200 Venture Royale	86					KN-146	
1235	XJR1300	00	YA-1295		RC-0984*	RC-1820DK <sup>4</sup>	KN-401	*Inc. 4 Filters
1235	XJR1300	01-05	YA-1295				KN-401	
1251	XJR1300	07-14	YA-1308				KN-401	
1251	XJR1300	15	YA-1308				KN-401	
1300	FJR1300	01-06	YA-1301				KN-148	
1300	FJR1300	13	YA-1301				KN-204*	*Chrome=KN-204C

2) Requires Two; 3) Requires Three; 4) Requires Four. The use of custom air filter requires removal of air box. Some custom filters and intakes are not legal for sale or use on any pollution controlled motor vehicle in California or states adopting California emission procedures. See knfilters.com for CARB status on each part for a specific vehicle.

# Motorcycle - Application Listing

CC	Model	Year	Air Filter	Air Filter Precharger	Custom	Custom Precharger	Oil Filter	Comments
<b>YAMAHA</b>								
1300	FJR1300A	03-09	YA-1301				KN-148	
1300	FJR1300A	10-15	YA-1301				KN-204*	*Chrome=KN-204C
1300	FJR1300A	16	YA-1301					
1300	FJR1300AE	05-06	YA-1301				KN-148	
1300	FJR1300AE	07					KN-148	
1300	FJR1300AE	08-09	YA-1301				KN-148	
1300	FJR1300AE	14-15	YA-1301				KN-204*	*Chrome=KN-204C
1300	FJR1300AE	16	YA-1301					
1300	FJR1300AS	06-09	YA-1301				KN-148	
1300	FJR1300AS	10-11	YA-1301				KN-204*	*Chrome=KN-204C
1300	FJR1300AS	14-15	YA-1301				KN-204*	*Chrome=KN-204C
1300	FJR1300AS	16	YA-1301					
1300	FJR1300ES	14-15	YA-1301				KN-204*	*Chrome=KN-204C
1300	XJR1300	95-97	YA-1295					
1300	XJR1300	98-99	YA-1295				KN-401	
1300	XVS13 Stryker Bullet Cowl	15-16	YA-1307				KN-204*	*Chrome=KN-204C
1300	XVS1300 V-Star	07-09	YA-1307				KN-147	
1300	XVS1300 V-Star	11-16	YA-1307				KN-204*	*Chrome=KN-204C
1300	XVS1300 V-Star Deluxe	13-15	YA-1307				KN-204*	*Chrome=KN-204C
1300	XVS1300 V-Star Tourer	07-09	YA-1307				KN-147	
1300	XVS1300 V-Star Tourer	10-15	YA-1307				KN-204*	*Chrome=KN-204C
1300	XVS13CA Stryker	11-16	YA-1307				KN-204*	*Chrome=KN-204C
1300	XVZ13	85-88					KN-146	
1300	XVZ1300 Royal Star	96-98	YA-1595				KN-303*	*Chrome=KN-303C
1300	XVZ1300 Royal Star	99-02					KN-303*	*Chrome=KN-303C
1300	XVZ1300 Royal Star Boulevard	99-01	YA-1595				KN-303*	*Chrome=KN-303C
1300	XVZ1300 Royal Star MM Ltd.	00	YA-1399				KN-303*	*Chrome=KN-303C
1300	XVZ1300 Royal Star Tour Classic	97					KN-303*	*Chrome=KN-303C
1300	XVZ1300 Royal Star Tour Classic	98-00	YA-1595				KN-303*	*Chrome=KN-303C
1300	XVZ1300 Royal Star Tour Deluxe	97-01	YA-1595				KN-303*	*Chrome=KN-303C
1300	XVZ1300 Royal Star Tour Deluxe	05-10	YA-1399				KN-303*	*Chrome=KN-303C
1300	XVZ1300 Royal Star Tour Deluxe S	08-09	YA-1399				KN-303*	*Chrome=KN-303C
1300	XVZ1300 Royal Star Venture	99-10	YA-1399				KN-303*	*Chrome=KN-303C
1300	XVZ1300 Royal Star Venture S	08-13	YA-1399				KN-303*	*Chrome=KN-303C
1300	XVZ1300 Venture Royale	86-93	YA-1283				KN-146	
1304	XVS1300A Midnight Star	07-12	YA-1307				KN-147	
1304	XVS1300A Midnight Star	13	YA-1307				KN-204*	*Chrome=KN-204C
1600	XV1600 Road Star	99-03	YA-1699		RK-3905-1*	E-3495PK	KN-303**	*Mirrored/ **Chrome=KN-303C
1600	XV1600 Road Star	99-03	YA-1699		RK-3915-1*	E-3495PK	KN-303**	*Grooved/ **Chrome=KN-303C
1600	XV1600 Road Star	99-03	YA-1699		RK-3925-1*	E-3495PK	KN-303**	*Flamed/ **Chrome=KN-303C
1600	XV1600 Road Star Silverado	99-03	YA-1699		RK-3905-1*	E-3495PK	KN-303**	*Mirrored/ **Chrome=KN-303C
1600	XV1600 Road Star Silverado	99-03	YA-1699		RK-3915-1*	E-3495PK	KN-303**	*Grooved/ **Chrome=KN-303C
1600	XV1600 Road Star Silverado	99-03	YA-1699		RK-3925-1*	E-3495PK	KN-303**	*Flamed/ **Chrome=KN-303C
1600	XV1600 Wild Star	99-04	YA-1699		RK-3905-1*	E-3495PK	KN-303**	*Mirrored/ **Chrome=KN-303C
1600	XV1600 Wild Star	99-04	YA-1699		RK-3915-1*	E-3495PK	KN-303**	*Grooved/ **Chrome=KN-303C
1600	XV1600 Wild Star	99-04	YA-1699		RK-3925-1*	E-3495PK	KN-303**	*Flamed/ **Chrome=KN-303C
1670	XV1700 Road Star Warrior	02-05	YA-1602		YA-1602-U*		KN-303**	*1 Filter for Speedstar Assy./ **Chrome=KN-303C
1670	XV1700 Road Star Warrior	06-09	YA-1602				KN-303*	*Chrome=KN-303C
1700	MT01	05-09	YA-1605				KN-303*	*Chrome=KN-303C
1700	VMX1700 V-Max	09-16	YA-1709				KN-303*	*Chrome=KN-303C
1700	XV1700 Road Star	04-09	YA-1704		RK-3905-1*	E-3495PK	KN-303**	*Mirrored/ **Chrome=KN-303C
1700	XV1700 Road Star	04-09	YA-1704		RK-3915-1*	E-3495PK	KN-303**	*Grooved/ **Chrome=KN-303C
1700	XV1700 Road Star	04-09	YA-1704		RK-3925-1*	E-3495PK	KN-303**	*Flamed/ **Chrome=KN-303C
1700	XV1700 Road Star S	08-12	YA-1704		RK-3905-1*	E-3495PK	KN-303**	*Mirrored/ **Chrome=KN-303C
1700	XV1700 Road Star S	08-12	YA-1704		RK-3915-1*	E-3495PK	KN-303**	*Grooved/ **Chrome=KN-303C
1700	XV1700 Road Star S	08-12	YA-1704		RK-3925-1*	E-3495PK	KN-303**	*Flamed/ **Chrome=KN-303C
1700	XV1700 Road Star S	13-14	YA-1704				KN-303*	*Chrome=KN-303C

2) Requires Two; 3) Requires Three; 4) Requires Four. The use of custom air filter requires removal of air box. Some custom filters and intakes are not legal for sale or use on any pollution controlled motor vehicle in California or states adopting California emission procedures. See knfilters.com for CARB status on each part for a specific vehicle.

# Motorcycle - Application Listing

CC	Model	Year	Air Filter	Air Filter Precharger	Custom	Custom Precharger	Oil Filter	Comments
<b>YAMAHA</b>								
1700	XV1700 Road Star Silverado	04-10	YA-1704		RK-3905-1*	E-3495PK	KN-303**	*Mirrored/ **Chrome=KN-303C
1700	XV1700 Road Star Silverado	04-10	YA-1704		RK-3915-1*	E-3495PK	KN-303**	*Grooved/ **Chrome=KN-303C
1700	XV1700 Road Star Silverado	04-10	YA-1704		RK-3925-1*	E-3495PK	KN-303**	*Flamed/ **Chrome=KN-303C
1700	XV1700 Road Star Silverado S	08-12	YA-1704		RK-3905-1*	E-3495PK	KN-303**	*Mirrored/ **Chrome=KN-303C
1700	XV1700 Road Star Silverado S	08-12	YA-1704		RK-3915-1*	E-3495PK	KN-303**	*Grooved/ **Chrome=KN-303C
1700	XV1700 Road Star Silverado S	08-12	YA-1704		RK-3925-1*	E-3495PK	KN-303**	*Flamed/ **Chrome=KN-303C
1700	XV1700 Road Star Silverado S	13-14	YA-1704				KN-303*	*Chrome=KN-303C
1854	XV1900 Midnight Star	10-13	YA-1906				KN-303*	*Chrome=KN-303C
1854	XV1900 Raider	10	YA-1906				KN-303*	*Chrome=KN-303C
1854	XV1900 Raider	11-15	YA-1906				KN-204*	*Chrome=KN-204C
1854	XV1900 Raider S	10	YA-1906				KN-303*	*Chrome=KN-303C
1854	XV1900 Raider S	11-15	YA-1906				KN-204*	*Chrome=KN-204C
1854	XV1900 Roadliner	12-13	YA-1906				KN-204*	*Chrome=KN-204C
1854	XV1900 Stratoliner	13	YA-1906				KN-204*	*Chrome=KN-204C
1854	XV1900 Stratoliner Deluxe	12	YA-1906				KN-204*	*Chrome=KN-204C
1854	XV1900 Stratoliner Deluxe	14	YA-1906				KN-204*	*Chrome=KN-204C
1854	XV19C Raider	15-16	YA-1906				KN-204*	*Chrome=KN-204C
1854	XV19C Raider Bullet Cowl	15	YA-1906				KN-204*	*Chrome=KN-204C
1854	XV19C Raider SCL	12-13					KN-204*	*Chrome=KN-204C
1854	XV19C Raider SCL	14	YA-1906				KN-204*	*Chrome=KN-204C
1854	XV19CS Raider S	15	YA-1906				KN-204*	*Chrome=KN-204C
1900	XV1900 Midnight Star	06-09	YA-1906				KN-303*	*Chrome=KN-303C
1900	XV1900 Raider	08-09	YA-1906				KN-303*	*Chrome=KN-303C
1900	XV1900 Raider S	08-09	YA-1906				KN-303*	*Chrome=KN-303C
1900	XV1900 Roadliner	06-07	YA-1906				KN-303*	*Chrome=KN-303C
1900	XV1900 Roadliner	10	YA-1906				KN-303*	*Chrome=KN-303C
1900	XV1900 Stratoliner	06-07	YA-1906				KN-303*	*Chrome=KN-303C
1900	XV1900 Stratoliner	09-10	YA-1906				KN-303*	*Chrome=KN-303C
1900	XV1900 Stratoliner Deluxe	10-11	YA-1906				KN-303*	*Chrome=KN-303C

2) Requires Two; 3) Requires Three; 4) Requires Four. The use of custom air filter requires removal of air box. Some custom filters and intakes are not legal for sale or use on any pollution controlled motor vehicle in California or states adopting California emission procedures. See knfilters.com for CARB status on each part for a specific vehicle.

# ATV - Application Listing

CC	Model	Year	Air Filter	Air Filter Precharger	Custom	Custom Precharger	Oil Filter	Comments
<b>ARCTIC CAT</b>								
249	250 2x4	99-05	AC-3098	AC-3098PK			KN-132	
249	250 2x4	06-09	KY-2504	SU-2504PK				
250	DVX250	06-08	KY-2504	SU-2504PK				
280	300	10	KY-2504	SU-2504PK				
280	300 2x4	98-03	AC-3098	AC-3098PK			KN-132	
280	300 4x4	98-05	AC-3098	AC-3098PK			KN-132	
280	300 DVX	10	KY-2504	SU-2504PK				
300	DVX300	09	KY-2504	SU-2504PK				
371	400	98-02	AC-4096-1	AC-4096PK			KN-138*	*Chrome=KN-138C
376	375 2x4	02	AC-4096-1	AC-4096PK			KN-138*	*Chrome=KN-138C
376	400	03-04	AC-4096-1	AC-4096PK			KN-138*	*Chrome=KN-138C
400	400 4x4	01-05	AC-4096-1	AC-4096PK			KN-138*	*Chrome=KN-138C
400	400 4x4	06-07	AC-4004				KN-138*	*Chrome=KN-138C
400	400 4x4 Auto	03-05	AC-4096-1	AC-4096PK			KN-138*	*Chrome=KN-138C
400	400 4x4 Auto	06-08	AC-4004				KN-138*	*Chrome=KN-138C
400	DVX400	04-08	SU-4002	SU-4002PK	SU-4002-T	SU-4002-TDK	KN-139	
443	Prowler HDX 500	15	AC-7009				KN-621	
454	454 2x4	96-98	AC-4096-1	AC-4096PK			KN-138*	*Chrome=KN-138C
454	454 4x4	96-98	AC-4096-1	AC-4096PK			KN-138*	*Chrome=KN-138C
487	500 4x4	98-02	AC-4096-1	AC-4096PK			KN-138*	*Chrome=KN-138C
500	500 4x4	05-08	AC-4004				KN-138*	*Chrome=KN-138C
500	500 4x4	09	AC-4004				KN-621	
500	500 4x4 Auto	00-02	AC-4096-1	AC-4096PK			KN-138*	*Chrome=KN-138C
500	500 4x4 Auto	05-07	AC-4004				KN-138*	*Chrome=KN-138C
500	500 4x4 Auto	08-09	AC-4004				KN-621	
545	550	14	AC-7009				KN-621	
545	550 4x4 Auto	10-11	AC-7009				KN-621	
545	550 Core	13	AC-7009				KN-621	
545	550 H1 EFI	09-11	AC-7009				KN-621	
545	550 LTD	11	AC-7009					
545	550 LTD	14	AC-7009				KN-621	
545	550 XT	13-14	AC-7009				KN-621	
545	Prowler 550 H1 EFI	09	AC-7009				KN-621	
545	Prowler 550 XT	10-11	AC-7009				KN-621	
545	Prowler 550 XT	13-14	AC-7009				KN-621	
545	Prowler XT550i	12	AC-7009				KN-621	
545	TRV550 H1 EFI	09-11	AC-7009				KN-621	
545	TRV550 LTD	13-15	AC-7009				KN-621	
545	TRV550 XT	13-15	AC-7009				KN-621	
545	TRV550i GT EFI	12	AC-7009				KN-621	
550	TRV550i Cruiser EFI	12	AC-7009				KN-621	
641	650 H1 4x4 Auto	05	AC-4004				KN-138*	*Chrome=KN-138C
641	650 H1 4x4 Auto	07	AC-4004				KN-621	
641	650 H1 4x4 Auto	08-09	AC-7009				KN-621	
641	650 H1 4x4 Auto	10	AC-4004				KN-621	
641	650 H1 4x4 Auto	11	AC-4004					
641	650 Mudpro 4x4	10-11	AC-7009					
641	Prowler 650 H1	07	AC-4004				KN-621	
641	Prowler 650 H1	08-09	AC-7009					
641	TRV650 H1	08	AC-7009					
641	TRV650 H1	09	AC-7009				KN-621	
650	650 4x4 Auto	04	AC-6504				KN-204*	*Chrome=KN-204C
650	650 H1 4x4 SE	06	AC-6504				KN-621	
650	650 H1 4x4 TRV Plus LE	07	AC-4004				KN-621	
650	650 V2 4x4	06	AC-6504				KN-204*	*Chrome=KN-204C
650	650 V2 4x4 Auto	05	AC-6504				KN-204*	*Chrome=KN-204C
650	650 V2 4x4 LE TS	06	AC-6504				KN-204*	*Chrome=KN-204C

2) Requires Two; 3) Requires Three; 4) Requires Four. The use of custom air filter requires removal of air box. Some custom filters and intakes are not legal for sale or use on any pollution controlled motor vehicle in California or states adopting California emission procedures. See knfilters.com for CARB status on each part for a specific vehicle.

# ATV - Application Listing

CC	Model	Year	Air Filter	Air Filter Precharger	Custom	Custom Precharger	Oil Filter	Comments
<b>ARCTIC CAT</b>								
650	Prowler 650 4x4 Auto	08	AC-7009				KN-621	
650	Prowler XT 650 H1	06-07	AC-4004				KN-621	
650	Prowler XT 650 H1	09	AC-7009				KN-621	
695	700	14	AC-7009				KN-621	
695	700 Core	13	AC-7009				KN-621	
695	700 H1 EFI	08-12	AC-7009				KN-621	
695	700 XT	13-14	AC-7009				KN-621	
695	700 XT	15	AC-7009					
695	700S	10-11	AC-7009				KN-621	
695	Prowler 700	08	AC-7009					
695	Prowler 700	10	AC-7009				KN-621	
695	Prowler HDX 700	11	AC-7009				KN-621	
695	Prowler HDX 700 XT	15	AC-7009				KN-621	
695	Prowler HDX 700i	13	AC-7009				KN-621	
695	Prowler XT 700 H1 EFI	09	AC-7009				KN-621	
695	Prowler XTX 700	10-11	AC-7009				KN-621	
695	Prowler XTX 700 H1 EFI	10-11	AC-7009				KN-621	
695	Prowler XTX700i	13	AC-7009				KN-621	
695	TBX700	14-15	AC-7009				KN-621	
695	TBX700 LTD	11	AC-7009					
695	TBX700 XT	13	AC-7009				KN-621	
695	TRV700 H1 EFI	09-12	AC-7009				KN-621	
695	TRV700 LTD	13-15	AC-7009				KN-621	
695	TRV700 S	10-11	AC-7009				KN-621	
695	TRV700 XT	13-15	AC-7009				KN-621	
695	TRV700i GT	12	AC-7009				KN-621	
700	TBX700i GT	12	AC-7009				KN-621	
700	Wildcat Sport	15-16	AC-7014				KN-621	
700	Wildcat Trail	14	AC-7014					
700	Wildcat Trail	15-16	AC-7014				KN-621	
700	Wildcat Trail XT	14	AC-7014					
700	Wildcat Trail XT	15	AC-7014				KN-621	
700	XTX700i Prowler 4X4	12	AC-7009				KN-621	
951	1000 MudPro	11	AC-1009					
951	1000 MudPro EFI H2 4x4 Auto	10-11	AC-1009					
951	1000 XT	13-14	AC-1009				KN-621	
951	1000i GT	12	AC-1009					
951	1000i MudPro LTD	12-14	AC-1009				KN-621	
951	1000S	11	AC-1009					
951	Prowler XTZ 1000 H2 EFI	09-11	AC-7009				KN-621	
951	Prowler XTZ1000i	13-14	AC-7009				KN-621	
951	Thundercat	09	AC-1009				KN-621	
951	TRV1000	12	AC-1009				KN-621	
951	TRV1000 EFI Cruiser	11	AC-1009				KN-621	
951	TRV1000 H2 EFI	10	AC-1009				KN-621	
951	TRV1000 H2 EFI Cruiser	09	AC-1009				KN-621	
951	Wildcat X LTD	14-16	AC-1012	AC-1012DK			KN-621	
951	Wildcat X Special Edition	16	AC-1012	AC-1012DK			KN-621	
951	XTZ1000i Prowler	12	AC-7009					
1000	Thundercat	08	AC-1009				KN-621	
1000	Thundercat 1000 H2	10	AC-1009				KN-621	
1000	Wildcat 1000	12	AC-1012	AC-1012DK				
1000	Wildcat 1000	13-14	AC-1012	AC-1012DK			KN-621	
1000	Wildcat 4 1000	13-14	AC-1012	AC-1012DK			KN-621	
1000	Wildcat 4X LTD	14	AC-1012	AC-1012DK			KN-621	
<b>BOMBARDIER</b>								
330	Outlander 330 HO 2x4	03-05	BD-3303	RU-0510PK			KN-152	

2) Requires Two; 3) Requires Three; 4) Requires Four. The use of custom air filter requires removal of air box. Some custom filters and intakes are not legal for sale or use on any pollution controlled motor vehicle in California or states adopting California emission procedures. See knfilters.com for CARB status on each part for a specific vehicle.

# ATV - Application Listing

CC	Model	Year	Air Filter	Air Filter Precharger	Custom	Custom Precharger	Oil Filter	Comments
<b>BOMBARDIER</b>								
330	Outlander 330 HO 4x4	03-05	BD-3303	RU-0510PK			KN-152	
400	Outlander 400 HO 2x4	03-04	BD-3303	RU-0510PK			KN-152	
400	Outlander 400 HO 4x4	03-06	BD-3303	RU-0510PK			KN-152	
400	Outlander 400 HO 4x4 XT	03-06	BD-3303	RU-0510PK			KN-152	
400	Outlander Max 400 HO	06	BD-3303	RU-0510PK			KN-152	
400	Outlander Max 400 HO XT	04-06	BD-3303	RU-0510PK			KN-152	
403	Outlander Max 400 HO	04-05	BD-3303	RU-0510PK			KN-152	
495	Quest 500	04	BD-6502	22-8013PK			KN-556	
498	Traxter 500 Auto	04	BD-6502	22-8013PK			KN-557	
498	Traxter 500 Auto CVT	05	BD-6502	22-8013PK			KN-556	
498	Traxter 500 XL	03-04	BD-6502	22-8013PK			KN-557	
500	Traxter 500 5 Speed	05	BD-6502	22-8013PK			KN-557	
500	Traxter 500 Auto XT	04	BD-6502	22-8013PK			KN-557	
500	Traxter 500 XL	05	BD-6502	22-8013PK			KN-557	
500	Traxter 500 XT	01-02	BD-6502	22-8013PK			KN-557	
500	Traxter 500 XT	05	BD-6502	22-8013PK			KN-557	
500	Traxter Max 500 XT	04-05	BD-6502	22-8013PK			KN-557	
644	DS650	00	BD-6500	YA-3502DK			KN-151	
644	DS650	00	BD-6500	YA-3502PK			KN-151	
644	DS650	01-03	BD-6500	YA-3502DK			KN-152	
644	DS650	01-03	BD-6500	YA-3502PK			KN-152	
644	DS650X	05-06	BD-6500	YA-3502DK			KN-152	
644	DS650X	05-06	BD-6500	YA-3502PK			KN-152	
644	Quest 650	02-04	BD-6502	22-8013PK			KN-556	
650	DS650	04-05	BD-6500	YA-3502DK			KN-152	
650	DS650	04-05	BD-6500	YA-3502PK			KN-152	
650	DS650 Baja X	04	BD-6500	YA-3502DK			KN-152	
650	DS650 Baja X	04	BD-6500	YA-3502PK			KN-152	
650	Outlander 650 HO EFI 4x4	06	BD-6506	22-8016PK			KN-152	
650	Outlander Max 650 HO EFI 4x4	06	BD-6506	22-8016PK			KN-152	
650	Quest 650 Max	04	BD-6502	22-8013PK			KN-556	
650	Traxter 650 Auto CVT	05	BD-6502	22-8013PK			KN-556	
650	Traxter Max 650 Auto CVT	05	BD-6502	22-8013PK			KN-556	
800	Outlander 800 HO 4x4 EFI	06	BD-6506	22-8016PK			KN-152	
800	Outlander Max 800 HO EFI 4x4	06	BD-6506	22-8016PK			KN-152	
<b>CAN-AM</b>								
400	Outlander 400 HO	07-08	BD-3303	RU-0510PK			KN-152	
400	Outlander 400 HO XT	07-08	BD-3303	RU-0510PK			KN-152	
400	Outlander Max 400 HO	07-08	BD-3303	RU-0510PK			KN-152	
400	Outlander Max 400 HO XT	07-08	BD-3303	RU-0510PK			KN-152	
450	DS450	08-09	CM-4508	CM-4508DK			KN-560	
450	DS450	14	CM-4508	CM-4508DK			KN-560	
450	DS450 EFI	09-12	CM-4508	CM-4508DK			KN-560	
450	DS450X	08	CM-4508	CM-4508DK			KN-560	
450	Outlander L 450	15	CM-8012				KN-152	
450	Outlander L 450 DPS	15	CM-8012				KN-152	
450	Outlander L Max 450	15	CM-8012				KN-152	
450	Outlander L Max 450 DPS	15	CM-8012				KN-152	
500	Outlander 500 EFI	10-12	BD-6506	22-8016PK			KN-152	
500	Outlander 500 EFI	13-14	CM-8012				KN-152	
500	Outlander 500 HO 4x4 EFI	07-09	BD-6506	22-8016PK			KN-152	
500	Outlander L 500	15	CM-8012				KN-152	
500	Outlander L 500 DPS	15	CM-8012				KN-152	
500	Outlander L Max 500	15	CM-8012				KN-152	
500	Outlander L Max 500 DPS	15	CM-8012				KN-152	
500	Outlander Max 500 HO EFI	07-08	BD-6506	22-8016PK			KN-152	
500	Outlander Max 500 HO EFI	10	BD-6506	22-8016PK			KN-152	

2) Requires Two; 3) Requires Three; 4) Requires Four. The use of custom air filter requires removal of air box. Some custom filters and intakes are not legal for sale or use on any pollution controlled motor vehicle in California or states adopting California emission procedures. See knfilters.com for CARB status on each part for a specific vehicle.

# ATV - Application Listing

CC	Model	Year	Air Filter	Air Filter Precharger	Custom	Custom Precharger	Oil Filter	Comments
<b>CAN-AM</b>								
500	Renegade 500	08-12	BD-6506	22-8016PK			KN-152	
500	Renegade 500	13-15	CM-8012				KN-152	
650	DS650X	07	BD-6500	YA-3502DK			KN-152	
650	DS650X	07	BD-6500	YA-3502PK			KN-152	
650	Outlander 650 6x6 XT	15	CM-8012				KN-152	
650	Outlander 650 EFI	09	BD-6506	22-8016PK			KN-152	
650	Outlander 650 EFI	10-12	CM-8009				KN-152	
650	Outlander 650 EFI	13-15	CM-8012				KN-152	
650	Outlander 650 HO EFI 4x4	07-08	BD-6506	22-8016PK			KN-152	
650	Outlander Max 650 HO EFI	07-08	BD-6506	22-8016PK			KN-152	
800	Commander 800R	11-15	CM-8011				KN-152	
800	Commander 800R DPS	14-15	CM-8011				KN-152	
800	Outlander 800 HO 4x4 EFI	07-08	BD-6506	22-8016PK			KN-152	
800	Outlander 800R EFI	09-11	CM-8009				KN-152	
800	Outlander 800R EFI	12-15	CM-8012				KN-152	
800	Outlander Max 800 HO EFI	07-08	BD-6506	22-8016PK			KN-152	
800	Outlander Max 800R EFI	09-12	CM-8009				KN-152	
800	Renegade 800	07-08	BD-6506	22-8016PK			KN-152	
800	Renegade 800	09-10	CM-8009				KN-152	
800	Renegade 800R	11	CM-8009				KN-152	
800	Renegade 800R	12-15	CM-8012				KN-152	
976	Maverick 1000R	13	CM-8011					
976	Maverick 1000R	14-15	CM-8011				KN-152	
976	Maverick 1000R Turbo X ds	15-16	CM-9715				KN-152	
976	Maverick 1000R X ds	15	CM-8011*				KN-152	*Exc. Turbo
976	Maverick Max 1000R Turbo X ds	15-16	CM-9715				KN-152	
976	Maverick Max 1000R X ds	15	CM-8011*				KN-152	*Exc. Turbo
1000	Commander 1000	11-14	CM-8011				KN-152	
1000	Outlander 1000 6x6 XT	15	CM-8012				KN-152	
1000	Outlander 1000 EFI	12	CM-8012				KN-152	
1000	Renegade 1000	12-15	CM-8012				KN-152	
<b>HONDA</b>								
90	TRX90	93-06	HA-1088	22-8008PK				
90	TRX90EX	07-08	HA-1088	22-8008PK				
90	TRX90X	09	HA-1088	22-8008PK				
90	TRX90X	12-16	HA-1088	22-8008PK				
225	TRX250 Recon	97-98	HA-2597	YA-3504PK				
225	TRX250EX	01-08	HA-2501	YA-3504PK				
250	TRX250 Recon	99-01	HA-2597	YA-3504PK				
250	TRX250TE Recon ES	02-09	HA-2501	YA-3504PK				
250	TRX250TE Recon ES	11-14	HA-2501	YA-3504PK				
250	TRX250TM Recon	02-09	HA-2501	YA-3504PK				
250	TRX250TM Recon	11-14	HA-2501	YA-3504PK				
250	TRX250X	09	HA-2501	YA-3504PK				
250	TRX250X	11-16	HA-2501	YA-3504PK				
350	TRX350D Foreman 4x4	87-89	HA-4435				KN-113	
397	TRX400EX	99-08	HA-4099	22-8016PK	HA-4099-T	HA-4099-TDK	KN-113	
397	TRX400EX	99-08	HA-4099	22-8016PK	HA-4099-T	HA-4099-TPK	KN-113	
400	TRX400X	09	HA-4099	22-8016PK	HA-4099-T	HA-4099-TDK	KN-113	
400	TRX400X	09	HA-4099	22-8016PK	HA-4099-T	HA-4099-TPK	KN-113	
400	TRX400X	12-14	HA-4099	22-8016PK	HA-4099-T	HA-4099-TDK	KN-113	
400	TRX400X	12-14	HA-4099	22-8016PK	HA-4099-T	HA-4099-TPK	KN-113	
420	TRX420FA Rancher AT	09-13	HA-4207				KN-114	
420	TRX420FA Rancher AT	14	HA-5000	HA-5000PK			KN-114	
420	TRX420FA5 FourTrax Rancher 4x4 Auto DCT IRS	15-16	HA-5000	HA-5000PK			KN-114	
420	TRX420FA6 FourTrax Rancher 4x4 Auto DCT IRS EPS	15-16	HA-5000	HA-5000PK			KN-114	

2) Requires Two; 3) Requires Three; 4) Requires Four. The use of custom air filter requires removal of air box. Some custom filters and intakes are not legal for sale or use on any pollution controlled motor vehicle in California or states adopting California emission procedures. See knfilters.com for CARB status on each part for a specific vehicle.



# ATV - Application Listing

CC	Model	Year	Air Filter	Air Filter Precharger	Custom	Custom Precharger	Oil Filter	Comments
<b>HONDA</b>								
420	TRX420FE FourTrax Rancher 4X4 ES	07-13	HA-4207				KN-113*	*w/Manual Trans.
420	TRX420FM FourTrax Rancher 4X4	07-13	HA-4207				KN-113*	*w/Manual Trans.
420	TRX420FM1 FourTrax Rancher 4x4	14	HA-5000	HA-5000PK			KN-113*	*w/Manual Trans.
420	TRX420FM1 FourTrax Rancher 4x4	15-16	HA-5000	HA-5000PK			KN-113	
420	TRX420TM FourTrax Rancher	07-13	HA-4207				KN-113*	*w/Manual Trans.
420	TRX420TM1 FourTrax Rancher	14	HA-5000	HA-5000PK			KN-113*	*w/Manual Trans.
420	TRX420TM1 FourTrax Rancher	15-16	HA-5000	HA-5000PK			KN-113	
450	TRX450ER	06-09	BD-6500	YA-3502DK	HA-4506-T	HA-4504-TDK	KN-116	
450	TRX450ER	06-09	BD-6500	YA-3502PK	HA-4506-T	HA-4504-TDK	KN-116	
450	TRX450ER	12-14	BD-6500	YA-3502DK	HA-4506-T	HA-4504-TDK	KN-116	
450	TRX450ER	12-14	BD-6500	YA-3502PK	HA-4506-T	HA-4504-TDK	KN-116	
450	TRX450R	06-09	BD-6500	YA-3502DK	HA-4506-T	HA-4504-TDK	KN-116	
450	TRX450R	06-09	BD-6500	YA-3502PK	HA-4506-T	HA-4504-TDK	KN-116	
450	TRX450R	12	BD-6500	YA-3502DK	HA-4506-T	HA-4504-TDK	KN-116	
450	TRX450R	12	BD-6500	YA-3502PK	HA-4506-T	HA-4504-TDK	KN-116	
475	SXS500M2 Pioneer	15-16	HA-5015				KN-113	
475	TRX500FA5 FourTrax Foreman Rubicon Auto DCT	15-16	HA-6806	HA-6806DK			KN-114	
475	TRX500FA6 FourTrax Foreman Rubicon Auto DCT EPS	15-16	HA-6806	HA-6806DK			KN-114	
475	TRX500FA6D FourTrax Foreman Rubicon Auto DCT EPS D	15	HA-6806	HA-6806DK			KN-114	
475	TRX500FA6D FourTrax Foreman Rubicon Auto DCT EPS D	16	HA-6806	HA-6806DK			KN-114	
475	TRX500FE FourTrax Foreman 4x4 ES	05-09	HA-5000	HA-5000PK			KN-113	
475	TRX500FE FourTrax Foreman 4x4 ES	11-13	HA-5000	HA-5000PK			KN-113	
475	TRX500FE1 FourTrax Foreman 4x4 ES	14-16	HA-5000	HA-5000PK			KN-113	
475	TRX500FM FourTrax Foreman 4x4	05-09	HA-5000	HA-5000PK			KN-113	
475	TRX500FM FourTrax Foreman 4x4	11-13	HA-5000	HA-5000PK			KN-113	
475	TRX500FM1 FourTrax Foreman 4x4	14-16	HA-5000	HA-5000PK			KN-113	
475	TRX500FM5 FourTrax Foreman Rubicon	15-16	HA-6806	HA-6806DK			KN-113	
475	TRX500FM6 FourTrax Foreman Rubicon EPS	15-16	HA-6806	HA-6806DK			KN-113	
475	TRX500FM6D FourTrax Foreman Rubicon EPS DLX	15	HA-6806	HA-6806DK			KN-113	
475	TRX500FM6D FourTrax Foreman Rubicon EPS DLX	16	HA-6806	HA-6806DK			KN-113	
499	TRX500FA Foreman Rubicon	12-14	HA-6806	HA-6806DK			KN-111	
500	TRX500FA Foreman Rubicon	01-09	HA-5000	HA-5000PK			KN-111	
500	TRX500FA Foreman Rubicon	11	HA-5000	HA-5000PK			KN-111	
500	TRX500TM Foreman	05-06	HA-5000	HA-5000PK			KN-113	
644	TRX650FA Rincon	03-05	HA-5000	HA-5000PK			KN-111	
675	MUV700 Big Red	09	HA-5000	HA-5000PK			KN-111	
675	MUV700 Big Red	10-13	HA-5000	HA-5000PK			KN-111	
680	TRX680FA Rincon	06-16	HA-6806	HA-6806DK			KN-111	
700	TRX700XX	08-09	HA-6808				KN-112	
<b>KAWASAKI</b>								
80	KFX80	03-06	SU-8087					
249	KSF250 Mojave	87-03	KA-2587	25-2587			KN-123	
250	KSF250 Mojave	04	KA-2587	25-2587			KN-123	
290	KEF300 Lakota	95-00	KA-2587	25-2587			KN-123	
290	KEF300 Lakota Sport	01-02	KA-2587	25-2587			KN-123	
360	KVF360 Prairie 2x4	04-09	KA-3603	KA-3603PK			KN-204*	*Chrome=KN-204C
360	KVF360 Prairie 4x4	03-13	KA-3603	KA-3603PK			KN-204*	*Chrome=KN-204C
392	KVF360 Prairie 2x4	03	KA-3603	KA-3603PK			KN-204*	*Chrome=KN-204C
400	KFX400	03-06	SU-4002	SU-4002PK	SU-4002-T	SU-4002-TDK	KN-139	
449	KFX450R	08-09	KA-4508	KA-4508DK	63-1124	RC-4630DK	KN-112	
449	KFX450R	10-14	KA-4508	KA-4508DK			KN-112	
617	KAF620 Mule 4000	09-10	KA-6201				KN-128	

2) Requires Two; 3) Requires Three; 4) Requires Four. The use of custom air filter requires removal of air box. Some custom filters and intakes are not legal for sale or use on any pollution controlled motor vehicle in California or states adopting California emission procedures. See knfilters.com for CARB status on each part for a specific vehicle.

# ATV - Application Listing

CC	Model	Year	Air Filter	Air Filter Precharger	Custom	Custom Precharger	Oil Filter	Comments
<b>KAWASAKI</b>								
617	KAF620 Mule 4000	12-15	KA-6201				KN-128	
617	KAF620 Mule 4010 4x4	09-16	KA-6201				KN-128	
620	KAF620 Mule 3000	01-08	KA-6201				KN-128	
620	KAF620 Mule 3010 4x4	01-08	KA-6201				KN-128	
620	KAF620 Mule 3020	01-03	KA-6201				KN-128	
635	KVF650 Prairie 4x4	02	KA-6502				KN-204*	*Chrome=KN-204C
635	KVF650 Prairie 4x4	03	KA-6503	KA-6503PK			KN-204*	*Chrome=KN-204C
650	KVF650 Brute Force 4x4	05-13	KA-6503	KA-6503PK			KN-204*	*Chrome=KN-204C
697	KFX700	05-06	KA-6503	KA-6503PK			KN-204*	*Chrome=KN-204C
697	KFX700 V Force	04	KA-6503	KA-6503PK			KN-204*	*Chrome=KN-204C
700	KFX700	07-09	KA-6503	KA-6503PK			KN-204*	*Chrome=KN-204C
700	KFX700	10-11	KA-6503	KA-6503PK			KN-204*	*Chrome=KN-204C
700	KVF700 Prairie 4x4	04-06	KA-6503	KA-6503PK			KN-204*	*Chrome=KN-204C
749	KRF750 Teryx FI 4x4	13	KA-7513				KN-204*	*Chrome=KN-204C
749	KRT750 Teryx4	12	KA-7512				KN-204*	*Chrome=KN-204C
750	KRF750 Teryx 4x4	08	KA-7508	KA-7508DK			KN-204*	*Chrome=KN-204C
750	KRF750 Teryx 4x4 LE	08	KA-7508	KA-7508DK			KN-204*	*Chrome=KN-204C
750	KRF750 Teryx FI 4x4	09-12	KA-7508	KA-7508DK			KN-204*	*Chrome=KN-204C
783	KRF800 Teryx	14	KA-7512				KN-204*	*Chrome=KN-204C
783	KRF800 Teryx	15-16	KA-7512				KN-204*	*Chrome=KN-204C
783	KRF800 Teryx Camo	14	KA-7512				KN-204*	*Chrome=KN-204C
783	KRF800 Teryx Camo	15-16	KA-7512				KN-204*	*Chrome=KN-204C
783	KRF800 Teryx LE	14	KA-7512				KN-204*	*Chrome=KN-204C
783	KRF800 Teryx LE	15-16	KA-7512				KN-204*	*Chrome=KN-204C
783	KRT800 Teryx4	14	KA-7512				KN-204*	*Chrome=KN-204C
783	KRT800 Teryx4	15	KA-7512				KN-204*	*Chrome=KN-204C
783	KRT800 Teryx4 Camo	16	KA-7512				KN-204*	*Chrome=KN-204C
783	KRT800 Teryx4 Camo	14	KA-7512				KN-204*	*Chrome=KN-204C
783	KRT800 Teryx4 Camo	15	KA-7512				KN-204*	*Chrome=KN-204C
783	KRT800 Teryx4 Camo	16	KA-7512				KN-204*	*Chrome=KN-204C
783	KRT800 Teryx4 LE	14	KA-7512				KN-204*	*Chrome=KN-204C
783	KRT800 Teryx4 LE	15	KA-7512				KN-204*	*Chrome=KN-204C
783	KRT800 Teryx4 LE	16	KA-7512				KN-204*	*Chrome=KN-204C
950	KAF950 Mule 2510 Diesel	00-02	KA-6201					
950	KAF950 Mule 3010 Diesel 4x4	03-08	KA-6201					
953	KAF950 Mule 4010 Diesel 4x4	09-13	KA-6201					
<b>POLARIS</b>								
169	Ranger RZR 170	10-13	PL-1710	PL-1004PK				
169	RZR 170	14-16	PL-1710	PL-1004PK				
196	Phoenix 200	10-16	PL-1004	PL-1004PK				
200	Phoenix 200	05-09	PL-1004	PL-1004PK				
200	Sawtooth	06-07	PL-1004	PL-1004PK				
244	Trail Blazer 250	91-00	PL-1001					
244	Trail Blazer 250	01-02	PL-1004	PL-1004PK				
244	Trail Blazer 250	04-06	PL-1004	PL-1004PK				
244	Trail Boss 250	90-99	PL-1001					
244	Xplorer 250 4x4	00	PL-1001					
244	Xplorer 250 4x4	01-02	PL-1004	PL-1004PK				
250	Trail Blazer 250	90	PL-1001					
281	Trail Blazer 250	03	PL-1004	PL-1004PK				
281	Xplorer 300 4x4	96-99	PL-1001					
300	Hawkeye 300 2x4	06-07	PL-1004	PL-1004PK			KN-303*	*Chrome=KN-303C
300	Hawkeye 300 2x4	09-10	PL-1004	PL-1004PK			KN-303*	*Chrome=KN-303C
300	Hawkeye 300 4x4	07	PL-1004	PL-1004PK			KN-303*	*Chrome=KN-303C
300	Xpress 300	96-99	PL-1001					
325	Magnum 325 2x4	00	PL-1003	PL-1003PK			KN-303*	*Chrome=KN-303C

2) Requires Two; 3) Requires Three; 4) Requires Four. The use of custom air filter requires removal of air box. Some custom filters and intakes are not legal for sale or use on any pollution controlled motor vehicle in California or states adopting California emission procedures. See knfilters.com for CARB status on each part for a specific vehicle.

# ATV - Application Listing

CC	Model	Year	Air Filter	Air Filter Precharger	Custom	Custom Precharger	Oil Filter	Comments
<b>POLARIS</b>								
325	Magnum 325 2x4	01	PL-1003*	PL-1003PK			KN-303**	*Built Before 1/8/01/ **Chrome=KN-303C
325	Magnum 325 4x4	00	PL-1003	PL-1003PK			KN-303*	*Chrome=KN-303C
325	Magnum 325 4x4	01	PL-1003*	PL-1003PK			KN-303**	*Built Before 1/8/01/ **Chrome=KN-303C
325	Sportsman Ace	14-16	PL-3214	PL-3214DK				
325	Trail Boss 325 2x4	00	PL-1003	PL-1003PK			KN-303*	*Chrome=KN-303C
325	Trail Boss 325 2x4	01	PL-1003*	PL-1003PK			KN-303**	*Built Before 12/11/00/ **Chrome=KN-303C
325	Xpedition 325	00-02	PL-1003	PL-1003PK			KN-303*	*Chrome=KN-303C
329	Hawkeye 300 4x4	06	PL-1004	PL-1004PK			KN-303*	*Chrome=KN-303C
329	Sportsman 300	08-10	PL-1004	PL-1004PK			KN-303*	*Chrome=KN-303C
329	Sportsman 300 LE	08-09	PL-1004	PL-1004PK			KN-303*	*Chrome=KN-303C
329	Trail Blazer 330	10-13	PL-1003	PL-1003PK			KN-303*	*Chrome=KN-303C
329	Trail Boss 330	10-13	PL-1003	PL-1003PK			KN-303*	*Chrome=KN-303C
334	Sportsman 335	99-01	PL-1003	PL-1003PK			KN-303*	*Chrome=KN-303C
335	Worker 335	99	PL-1003	PL-1003PK			KN-303*	*Chrome=KN-303C
350	Trail Boss 350L 2x4	92	PL-1001					
377	Scrambler 400 4x4	96-02	PL-1002	PL-1002PK				
377	Sportsman 400 4x4	94-96	PL-1001					
377	Xplorer 400L	96-98	PL-1001				KN-303*	*Chrome=KN-303C
377	Xplorer 400L	99-00	PL-1002	PL-1002PK			KN-303*	*Chrome=KN-303C
377	Xplorer 400L	01	PL-1004	PL-1004PK			KN-303*	*Chrome=KN-303C
400	Big Boss 6x6 400L	95-97	PL-1001					
400	Scrambler 400 2x4	00-02	PL-1002	PL-1002PK				
400	Sport 400L	94-95	PL-1001					
400	Sport 400L	96-97	PL-1002	PL-1002PK				
400	Sport 400L	99	PL-1002	PL-1002PK				
400	Sportsman 400 2x4	01	PL-1003	PL-1003PK			KN-303*	*Chrome=KN-303C
400	Trail Blazer 400 2x4	03	PL-1002	PL-1002PK				
400	Xplorer 400L	02	PL-1004	PL-1004PK				
400	Xpress 400L	96-97	PL-1002	PL-1002PK				
425	Magnum 425 6x6	96-97	PL-1002	PL-1002PK			KN-303*	*Chrome=KN-303C
425	Ranger 2x4 425	01	PL-1003	PL-1003PK			KN-303*	*Chrome=KN-303C
425	Ranger 2x4 425	03	PL-5008	PL-5008DK			KN-303*	*Chrome=KN-303C
425	Xpedition	00-02	PL-1003	PL-1003PK			KN-303*	*Chrome=KN-303C
427	Magnum 425 4x4	95-98	PL-1002	PL-1002PK			KN-303*	*Chrome=KN-303C
427	Sportsman 400 4x4	01-05	PL-1003	PL-1003PK			KN-303*	*Chrome=KN-303C
455	Diesel 455	99-01	PL-1003	PL-1003PK			KN-303*	*Chrome=KN-303C
455	Ranger 4x4 400	10-14	PL-5008	PL-5008DK			KN-303*	*Chrome=KN-303C
455	Sportsman 400 H.O.	08-14	PL-1003	PL-1003PK			KN-303*	*Chrome=KN-303C
455	Sportsman 400 HO South Edition	13-14	PL-1003	PL-1003PK			KN-303*	*Chrome=KN-303C
455	Sportsman 450	06-07	PL-1003	PL-1003PK			KN-303*	*Chrome=KN-303C
496	ATP500 HO	04-05	PL-1003	PL-1003PK			KN-303*	*Chrome=KN-303C
496	Magnum 500 4x4	99-02	PL-1003	PL-1003PK			KN-303*	*Chrome=KN-303C
496	Predator 500	03-07	PL-5003				KN-112	
496	Sportsman 500	01	PL-1003	PL-1003PK			KN-303*	*Chrome=KN-303C
496	Sportsman 500 6x6	01-08	PL-1003	PL-1003PK			KN-303*	*Chrome=KN-303C
496	Sportsman 500 6x6	09	PL-1003	PL-1003PK				
496	Sportsman 500 EFI	06	PL-1003	PL-1003PK			KN-303*	*Chrome=KN-303C
496	Sportsman 500 EFI	08-09	PL-1003	PL-1003PK			KN-303*	*Chrome=KN-303C
498	Ranger 500 Crew	11	PL-5008	PL-5008DK			KN-198	
498	Ranger 500 Crew	12-13	PL-5008	PL-5008DK			KN-303*	*Chrome=KN-303C
498	Ranger 500 Crew LE	13	PL-5008	PL-5008DK			KN-303*	*Chrome=KN-303C
498	Ranger 500 Crew Turbo Silver LE	12	PL-5008	PL-5008DK			KN-303*	*Chrome=KN-303C
498	Sportsman 500 EFI	12	PL-1003	PL-1003PK			KN-303*	*Chrome=KN-303C
498	Sportsman 500 HO	10-13	PL-1003	PL-1003PK			KN-303*	*Chrome=KN-303C
498	Sportsman 500 HO Polaris Pursuite LE	12	PL-1003	PL-1003PK			KN-303*	*Chrome=KN-303C

2) Requires Two; 3) Requires Three; 4) Requires Four. The use of custom air filter requires removal of air box. Some custom filters and intakes are not legal for sale or use on any pollution controlled motor vehicle in California or states adopting California emission procedures. See knfilters.com for CARB status on each part for a specific vehicle.

# ATV - Application Listing

CC	Model	Year	Air Filter	Air Filter Precharger	Custom	Custom Precharger	Oil Filter	Comments
<b>POLARIS</b>								
498	Sportsman Forest 500	12	PL-1003	PL-1003PK				
498	Sportsman Forest 550	12	PL-1003	PL-1003PK				
498	Sportsman Forest 800	12	PL-1003	PL-1003PK				
498	Sportsman Forest 800 6x6	12	PL-1003	PL-1003PK				
498	Sportsman Forest 850	12	PL-5509	PL-1003PK				
498	Sportsman Forest Tractor 500	12	PL-1003	PL-1003PK				
499	Ranger 4x4 500 EFI	06-09	PL-5008	PL-5008DK			KN-303*	*Chrome=KN-303C
499	Ranger 4x4 EFI	10-13	PL-5008	PL-5008DK			KN-303*	*Chrome=KN-303C
499	Sportsman 500 EFI	07	PL-1003	PL-1003PK			KN-303*	*Chrome=KN-303C
499	Sportsman 500 EFI Deluxe	07	PL-1003	PL-1003PK			KN-303*	*Chrome=KN-303C
500	Big Boss 500 6x6	98-99	PL-1002	PL-1002PK			KN-303*	*Chrome=KN-303C
500	Magnum 500 4x4	03	PL-1003	PL-1003PK			KN-303*	*Chrome=KN-303C
500	Outlaw 500	06-07	PL-5006	PL-5006DK			KN-112	
500	Ranger 2x4 500	04-08	PL-5008	PL-5008DK			KN-303*	*Chrome=KN-303C
500	Ranger 4x4 500	03-06	PL-5008	PL-5008DK			KN-303*	*Chrome=KN-303C
500	Ranger 6x6 500	00	PL-5008	PL-5008DK			KN-303*	*Chrome=KN-303C
500	Ranger 6x6 500	04-05	PL-5008	PL-5008DK			KN-303*	*Chrome=KN-303C
500	Scrambler 500 2x4	01-02	PL-1003	PL-1003PK			KN-303*	*Chrome=KN-303C
500	Scrambler 500 4x4	97-12	PL-1003	PL-1003PK			KN-303*	*Chrome=KN-303C
500	Sportsman 500	02	PL-1003	PL-1003PK			KN-303*	*Chrome=KN-303C
500	Sportsman 500 4x4	96-00	PL-1003	PL-1003PK			KN-303*	*Chrome=KN-303C
500	Sportsman 500 6x6	00	PL-1003	PL-1003PK			KN-303*	*Chrome=KN-303C
500	Sportsman 500 6x6 MV	07	PL-1003	PL-1003PK			KN-303*	*Chrome=KN-303C
500	Sportsman 500 EFI	10	PL-1003	PL-1003PK			KN-303*	*Chrome=KN-303C
500	Sportsman 500 HO	01	PL-1003	PL-1003PK			KN-303*	*Chrome=KN-303C
500	Sportsman 500 HO	04-06	PL-1003	PL-1003PK			KN-303*	*Chrome=KN-303C
500	Sportsman 500 HO	08-09	PL-1003	PL-1003PK			KN-303*	*Chrome=KN-303C
500	Sportsman 500 HO 4x4	02-03	PL-1003	PL-1003PK			KN-303*	*Chrome=KN-303C
500	Sportsman 500 HO RSE	01	PL-1003	PL-1003PK			KN-303*	*Chrome=KN-303C
500	Sportsman X2	06	PL-1003	PL-1003PK			KN-303*	*Chrome=KN-303C
500	Worker 500	99	PL-1003	PL-1003PK			KN-303*	*Chrome=KN-303C
500	Xplorer 500 4x4	97	PL-1003	PL-1003PK			KN-303*	*Chrome=KN-303C
525	Outlaw 525 IRS	07-11	PL-5207	PL-5207DK			KN-155*	*Tall Filter
525	Outlaw 525 IRS	07-11	PL-5207	PL-5207DK			KN-157*	*Short Filter
549	Sportsman 550	13-14	PL-1003	PL-1003PK				
550	Sportsman 550	10-12	PL-1003	PL-1003PK				
550	Sportsman 550 X2	10-14	PL-1003	PL-1003PK				
550	Sportsman 550 XP EFI	09-12	PL-5509	PL-1003PK				
567	Ranger RZR 570	12-14	PL-5712				KN-198	
567	RZR 570	14-15	PL-5712				KN-198	
567	Sportsman 570	14-16	PL-1003	PL-1003PK				
567	Sportsman 570 EPS	14-15	PL-1003	PL-1003PK				
567	Sportsman 570 SP	15	PL-1003	PL-1003PK				
567	Sportsman 570 SP Hunters Edition	15	PL-1003	PL-1003PK				
567	Sportsman 570 Touring SP	15	PL-1003	PL-1003PK				
567	Sportsman 570 X2 EPS	15	PL-1003	PL-1003PK				
567	Sportsman Ace 570	15-16	PL-3214	PL-3214DK				
597	Sportsman 600	03	PL-1003	PL-1003PK			KN-196	
597	Sportsman 600	04	PL-1003	PL-1003PK			KN-196*	*Built Before 10/2/03
597	Sportsman 600	04	PL-1003	PL-1003PK			KN-198*	*Built After 10/2/03
597	Sportsman 600	05	PL-1003	PL-1003PK			KN-198	
683	Ranger MVRS 700 4x4	08	PL-5008	PL-5008DK				
700	Ranger 6x6 700 EFI	06-09	PL-5008	PL-5008DK			KN-198	
700	Ranger Crew 700	08-09	PL-5008	PL-5008DK			KN-198	
700	Ranger HD	09	PL-5008	PL-5008DK			KN-198	
700	Ranger XP	05-09	PL-5008	PL-5008DK			KN-198	
700	Sportsman 700	02-03	PL-1003	PL-1003PK			KN-196	

2) Requires Two; 3) Requires Three; 4) Requires Four. The use of custom air filter requires removal of air box. Some custom filters and intakes are not legal for sale or use on any pollution controlled motor vehicle in California or states adopting California emission procedures. See knfilters.com for CARB status on each part for a specific vehicle.

# ATV - Application Listing

CC	Model	Year	Air Filter	Air Filter Precharger	Custom	Custom Precharger	Oil Filter	Comments
<b>POLARIS</b>								
700	Sportsman 700	04	PL-1003	PL-1003PK			KN-196*	*Built Before 10/8/04
700	Sportsman 700	04	PL-1003	PL-1003PK			KN-198*	*Built After 10/8/04
700	Sportsman 700	05-06	PL-1003	PL-1003PK			KN-198	
700	Sportsman 700 EFI	04	PL-1003	PL-1003PK			KN-196	
700	Sportsman 700 EFI	05-07	PL-1003	PL-1003PK			KN-198	
700	Sportsman 700 MV	07	PL-1003	PL-1003PK			KN-198	
700	Sportsman MV7	05	PL-1003	PL-1003PK			KN-198	
760	Ranger 6x6 800	10	PL-5008	PL-5008DK			KN-198	
760	Ranger 6x6 800	11-16	PL-8007	PL-8007DK			KN-198	
760	Ranger 800 EFI	13-14	PL-8007	PL-8007DK			KN-198	
760	Ranger 800 HD	10	PL-5008	PL-5008DK			KN-198	
760	Ranger 800 HD EPS	11-12	PL-5008	PL-5008DK			KN-198	
760	Ranger 800 XP	10	PL-5008	PL-5008DK				
760	Ranger 800 XP	11-12	PL-8007	PL-8007DK			KN-198	
760	Ranger 800 XP LE	12	PL-8007	PL-8007DK			KN-198	
760	Ranger Crew 800	10	PL-5008	PL-5008DK			KN-198	
760	Ranger Crew 800	11-14	PL-8007	PL-8007DK			KN-198	
760	Ranger MVRS 800 4x4	08	PL-5008	PL-5008DK				
760	Ranger RZR 4 800	10-11	PL-8007	PL-8007DK	63-1120	62-1300DK	KN-198	
760	Ranger RZR 4 800	10-11	PL-8007	PL-8007DK	63-1120	RX-3810DK	KN-198	
760	Ranger RZR 4 800	12-13	PL-8007	PL-8007DK			KN-198	
760	Ranger RZR 800	08-13	PL-8007	PL-8007DK	63-1120	62-1300DK	KN-198	
760	Ranger RZR 800	08-13	PL-8007	PL-8007DK	63-1120	RX-3810DK	KN-198	
760	Ranger RZR 800	14	PL-8007	PL-8007DK			KN-198	
760	Ranger RZR 800 LE	12-13	PL-8007	PL-8007DK	63-1120	62-1300DK	KN-198	
760	Ranger RZR 800 LE	12-13	PL-8007	PL-8007DK	63-1120	RX-3810DK	KN-198	
760	Ranger RZR 800 S	12-13	PL-8007	PL-8007DK	63-1120	62-1300DK	KN-198	
760	Ranger RZR 800 S	12-13	PL-8007	PL-8007DK	63-1120	RX-3810DK	KN-198	
760	Ranger RZR 800 S	14	PL-8007	PL-8007DK			KN-198	
760	Ranger RZR 800 S LE	12-13	PL-8007	PL-8007DK	63-1120	62-1300DK	KN-198	
760	Ranger RZR 800 S LE	12-13	PL-8007	PL-8007DK	63-1120	RX-3810DK	KN-198	
760	Ranger RZR S	09-11	PL-8007	PL-8007DK	63-1120	62-1300DK	KN-198	
760	Ranger RZR S	09-11	PL-8007	PL-8007DK	63-1120	RX-3810DK	KN-198	
760	RZR 800	14	PL-8007	PL-8007DK			KN-198	
760	RZR 800 XC Edition	14	PL-8007	PL-8007DK			KN-198	
760	RZR S 800	14	PL-8007	PL-8007DK			KN-198	
769	Sportsman 800 EFI	08	PL-1003	PL-1003PK			KN-198	
769	Sportsman 800 EFI HO	08-09	PL-1003	PL-1003PK			KN-198	
769	Sportsman 800 EFI Le	08	PL-1003	PL-1003PK			KN-198	
794	Sportsman 800 Twin EFI	05	PL-1003	PL-1003PK			KN-198	
800	Sportsman 800 Big Boss 6x6	12-14	PL-1003	PL-1003PK			KN-198	
800	Sportsman 800 EFI	06-07	PL-1003	PL-1003PK			KN-198	
800	Sportsman 800 EFI	09-14	PL-1003	PL-1003PK			KN-198	
800	Sportsman 800 EFI 6x6	10-11	PL-1003	PL-1003PK			KN-198	
800	Sportsman 800 EFI 6x6 Big Boss	09	PL-1003	PL-1003PK			KN-198	
800	Sportsman 800 EFI 6x6 Big Boss	12	PL-1003	PL-1003PK			KN-198	
850	Scrambler 850	15-16	PL-1003	PL-1003PK				
850	Scrambler 850 XP HO	13-14	PL-1003	PL-1003PK				
850	Sportsman 850	15	PL-1003	PL-1003PK				
850	Sportsman 850 HO Touring EPS Sunset Red LE	13	PL-1003	PL-1003PK				
850	Sportsman 850 SP	15	PL-1003	PL-1003PK				
850	Sportsman 850 Touring SP	15-16	PL-1003	PL-1003PK				
850	Sportsman 850 XP	10	PL-5509	PL-1003PK				
850	Sportsman 850 XP EFI	09-11	PL-5509	PL-1003PK				
850	Sportsman 850 XP H.O.	12-13	PL-5509	PL-1003PK				
875	Ranger 900 Crew	14	PL-5712				KN-198	
875	Ranger 900 XP	13-14	PL-5712				KN-198	

2) Requires Two; 3) Requires Three; 4) Requires Four. The use of custom air filter requires removal of air box. Some custom filters and intakes are not legal for sale or use on any pollution controlled motor vehicle in California or states adopting California emission procedures. See knfilters.com for CARB status on each part for a specific vehicle.

# ATV - Application Listing

CC	Model	Year	Air Filter	Air Filter Precharger	Custom	Custom Precharger	Oil Filter	Comments
<b>POLARIS</b>								
875	Ranger 900 XP Deluxe	14	PL-5712				KN-198	
875	Ranger RZR XP 4 900	12-13	PL-9011		63-1129	RC-5062DK	KN-198	
875	Ranger RZR XP 900	11-13	PL-9011		63-1129	RC-5062DK	KN-198	
875	Ranger RZR XP 900 EPS Walker Evans LE	13	PL-9011		63-1129	RC-5062DK	KN-198	
875	Ranger RZR XP 900 HO Jagged X Edition	13	PL-9011		63-1129	RC-5062DK	KN-198	
875	Ranger RZR XP 900 LE	11-13	PL-9011		63-1129	RC-5062DK	KN-198	
875	RZR 900	14	PL-9011		63-1129	RC-5062DK	KN-198	
875	RZR 900	15-16	PL-8715				KN-198	
875	RZR S 900	15-16	PL-8715				KN-198	
875	Sportsman Ace 900 SP	16	PL-8715				KN-198	
904	Ranger DSL	11-14	PL-8007	PL-8007DK				
925	RZR XP Turbo	16	PL-1014	PL-1014-1DK			KN-198	
999	General 1000 EPS	16	PL-8715				KN-198	
999	RZR S 1000 EPS	16	PL-8715				KN-198	
999	RZR XP 1000 EPS	14-16	PL-1014	PL-1014-1DK			KN-198	
999	RZR XP 1000 EPS Desert Edition	15	PL-1014	PL-1014-1DK			KN-198	
999	RZR XP 1000 EPS High Lifter Edition	15	PL-1014	PL-1014-1DK			KN-198	
999	RZR XP 4 1000 EPS	14-15	PL-1014	PL-1014-1DK			KN-198	
<b>SUZUKI</b>								
80	LT80 QuadSport	87-06	SU-8087					
160	LT160 Quadrunner	03	SU-1691	25-1691			KN-132	
160	LT160 QuadSport	04	SU-1691	25-1691			KN-132	
160	LT160E Quadrunner	89-92	SU-1691	25-1691			KN-132	
160	LTF160 Quadrunner	91-01	SU-1691	25-1691			KN-132	
230	LT230E Quadrunner	87-93	SU-2391				KN-132	
246	LTZ250 QuadSport Z	04-09	SU-2504	SU-2504PK			KN-132	
249	LTF250 Ozark	12-14	SU-2504	SU-2504PK			KN-132	
250	LT250 Quadrunner 2x4	88-02	SU-2588	25-2588			KN-132	
250	LT250 Quadrunner 2x4	88-02	SU-2588	AC-3098PK			KN-132	
250	LTF250 Ozark	02-09	SU-2504	SU-2504PK			KN-132	
250	LTF250 Quadrunner 2x4	99-01	SU-2588	25-2588			KN-132	
250	LTF250 Quadrunner 2x4	99-01	SU-2588	AC-3098PK			KN-132	
250	LTF250 Quadrunner 4x4	88-02	SU-2588	25-2588			KN-132	
250	LTF250 Quadrunner 4x4	88-02	SU-2588	AC-3098PK			KN-132	
300	LTF300 King Quad	91-02	SU-2588	25-2588			KN-132	
300	LTF300 King Quad	91-02	SU-2588	AC-3098PK			KN-132	
376	LTA400F KingQuad ASi	12-15	SU-5002	SU-4002PK			KN-138*	*Chrome=KN-138C
376	LTA400F KingQuad ASi LE	14	SU-5002	SU-4002PK			KN-138*	*Chrome=KN-138C
376	LTA400F KingQuad Auto 4x4	12	SU-5002	SU-4002PK			KN-138*	*Chrome=KN-138C
376	LTF400F KingQuad 4x4	12	SU-5002	SU-4002PK			KN-138*	*Chrome=KN-138C
376	LTF400F KingQuad FSi	13-15	SU-5002	SU-4002PK			KN-138*	*Chrome=KN-138C
376	LTF400F KingQuad FSi	16	SU-5002	SU-4002PK			KN-138*	*Chrome=KN-138C
376	LTF400F KingQuad FSi LE	14	SU-5002	SU-4002PK			KN-138*	*Chrome=KN-138C
398	LTZ400 QuadSport Z	03-09	SU-4002	SU-4002PK	SU-4002-T	SU-4002-TDK	KN-139	
398	LTZ400 QuadSport Z	12-13	SU-4002	SU-4002PK	SU-4002-T	SU-4002-TDK	KN-139	
400	LTA400 Eiger Auto 2x4	02-04	SU-5002	SU-4002PK			KN-138*	*Chrome=KN-138C
400	LTA400 Eiger Auto 2x4	06	SU-5002	SU-4002PK			KN-138*	*Chrome=KN-138C
400	LTA400F Eiger Auto 4x4	02-07	SU-5002	SU-4002PK			KN-138*	*Chrome=KN-138C
400	LTA400F KingQuad AS	10	SU-5002	SU-4002PK			KN-138*	*Chrome=KN-138C
400	LTA400F KingQuad Auto 4x4	08-09	SU-5002	SU-4002PK			KN-138*	*Chrome=KN-138C
400	LTA400F KingQuad Auto 4x4	11	SU-5002	SU-4002PK			KN-138*	*Chrome=KN-138C
400	LTF400 Eiger 2x4	02-04	SU-5002	SU-4002PK			KN-138*	*Chrome=KN-138C
400	LTF400F Eiger 4x4	02-07	SU-5002	SU-4002PK			KN-138*	*Chrome=KN-138C
400	LTF400F KingQuad 4x4	08-09	SU-5002	SU-4002PK			KN-138*	*Chrome=KN-138C
400	LTF400F KingQuad 4x4	11	SU-5002	SU-4002PK			KN-138*	*Chrome=KN-138C
450	LTA450X KingQuad 4x4	07	SU-7005	SU-7005DK			KN-138*	*Chrome=KN-138C
450	LTA450X KingQuad AXi 4x4	07-10	SU-7005	SU-7005DK			KN-138*	*Chrome=KN-138C

2) Requires Two; 3) Requires Three; 4) Requires Four. The use of custom air filter requires removal of air box. Some custom filters and intakes are not legal for sale or use on any pollution controlled motor vehicle in California or states adopting California emission procedures. See knfilters.com for CARB status on each part for a specific vehicle.

# ATV - Application Listing

CC	Model	Year	Air Filter	Air Filter Precharger	Custom	Custom Precharger	Oil Filter	Comments
<b>SUZUKI</b>								
450	LTR450 QuadRacer	06-08	SU-4506	SU-4506DK	63-1128	RC-5182DK	KN-139	
450	LTR450 QuadRacer	09	SU-4506	SU-4506DK			KN-139	
500	LTA500F Vinson Auto 4x4	02-07	SU-5002	SU-4002PK			KN-138*	*Chrome=KN-138C
500	LTF500F Vinson 4x4	03-07	SU-5002	SU-4002PK			KN-138*	*Chrome=KN-138C
700	LTA700X KingQuad 4x4	05-07	SU-7005	SU-7005DK			KN-138*	*Chrome=KN-138C
700	LTV700 Twin Peaks 4x4	04-05	KA-6503	KA-6503PK			KN-204*	*Chrome=KN-204C
750	LTA750X KingQuad AXi 4x4	08-09	SU-7005	SU-7005DK			KN-138*	*Chrome=KN-138C
750	LTA750X KingQuad AXi 4x4	11-14	SU-7005	SU-7005DK			KN-138*	*Chrome=KN-138C
750	LTA750X KingQuad AXi 4x4 LE	14	SU-7005	SU-7005DK			KN-138*	*Chrome=KN-138C
<b>YAMAHA</b>								
50	YFM50 Raptor	04-08	YA-8002					
80	YFM80 Badger	92-00	YA-8002					
80	YFM80 Grizzly	05-08	YA-8002					
80	YFM80 Raptor	02-08	YA-8002					
124	YFA125 Breeze	89-04	YA-2088	YA-2088PK				
124	YFM125 Grizzly	04-09	YA-2088	YA-2088PK				
124	YFM125 Grizzly	11-13	YA-2088	YA-2088PK				
124	YFM125 Raptor	11-13	YA-2088	YA-2088PK				
195	YFM250 Moto-4	90	YA-2597	YA-2597PK			KN-143	
200	YFS200 Blaster	88-06	YA-2088	YA-2088PK				
230	YFB250 Timberwolf	92-98	YA-2597	YA-2597PK			KN-143	
230	YFB250FW Timberwolf 4x4	94-00	YA-2597	YA-2597PK			KN-143	
230	YFM250 Bear Tracker	99-03	YA-4001	YA-4001PK			KN-143	
230	YFM250 Big Bear	07-09	YA-4001	YA-4001PK			KN-143	
230	YFM250 Bruin	05-06	YA-4001	YA-4001PK			KN-143	
249	YFM250 Raptor	08-13	YA-2088	YA-2088PK			KN-140	
249	YFM250R Raptor	11	YA-2088	YA-2088PK			KN-140	
250	YFM250 Bear Tracker	04	YA-4001	YA-4001PK			KN-143	
250	YFM250 Moto-4	89	YA-2597	YA-2597PK			KN-143	
250	YFM250 Moto-4	91	YA-2597	YA-2597PK			KN-143	
346	YFM350 Grizzly Auto 2x4	07-09	YA-3504	YA-3504PK			KN-204*	*Chrome=KN-204C
346	YFM350 Grizzly Auto 4x4	07-09	YA-3504	YA-3504PK			KN-204*	*Chrome=KN-204C
346	YFM350 Moto-4	90-95	YA-2597	YA-2597PK			KN-142	
346	YFM350FW Big Bear	90-98	YA-2597	YA-2597PK			KN-142	
348	YFM350R Raptor	08	YA-6602	YA-4350PK			KN-142	
350	YFM350 Bruin Auto 2x4	04-06	YA-3504	YA-3504PK			KN-303*	*Chrome=KN-303C
350	YFM350 Bruin Auto 4x4	04-06	YA-3504	YA-3504PK			KN-303*	*Chrome=KN-303C
350	YFM350 Grizzly Auto	12	YA-3504	YA-3504PK			KN-204*	*Chrome=KN-204C
350	YFM350 Grizzly Auto	14	YA-3504	YA-3504PK			KN-204*	*Chrome=KN-204C
350	YFM350 Grizzly Auto 2x4	10-11	YA-3504	YA-3504PK			KN-204*	*Chrome=KN-204C
350	YFM350 Grizzly Auto 4x4	10-14	YA-3504	YA-3504PK			KN-204*	*Chrome=KN-204C
350	YFM350 Moto-4	87-89	YA-2597	YA-2597PK			KN-142	
350	YFM350FW Big Bear	86-89	YA-2597	YA-2597PK			KN-142	
350	YFM350FX Wolverine	94-05	YA-4350	YA-4350PK			KN-142	
350	YFM350R Raptor	04-07	YA-6602	YA-4350PK			KN-142	
350	YFM350R Raptor	09-13	YA-6602	YA-4350PK			KN-142	
350	YFM350X Warrior	87-04	YA-4350	YA-4350PK			KN-142	
350	YFM350X Wolverine 2x4	06-09	YA-3504	YA-3504PK			KN-204*	*Chrome=KN-204C
350	YFZ350 Banshee	87-02	YA-3502	YA-3502DK	RU-0210 <sup>2</sup>	RU-0210PK <sup>2</sup>		
350	YFZ350 Banshee	87-02	YA-3502	YA-3502PK	RU-0210 <sup>2</sup>	RU-0210PK <sup>2</sup>		
350	YFZ350 Banshee	87-06	YA-3502	YA-3502DK	YA-3502-T	YA-3502-TDK		
350	YFZ350 Banshee	87-06	YA-3502	YA-3502PK	YA-3502-T	YA-3502-TDK		
384	YFM350FW Big Bear	99	YA-2597	YA-2597PK			KN-142	
384	YFM400 Big Bear	00	YA-4001	YA-4001PK			KN-142	
384	YFM400 Big Bear	04	YA-4001	YA-4001PK			KN-142	
384	YFM400 Big Bear 4x4	00	YA-4001	YA-4001PK			KN-142	
384	YFM400 Big Bear 4x4	04-06	YA-4001	YA-4001PK			KN-142	

2) Requires Two; 3) Requires Three; 4) Requires Four. The use of custom air filter requires removal of air box. Some custom filters and intakes are not legal for sale or use on any pollution controlled motor vehicle in California or states adopting California emission procedures. See knfilters.com for CARB status on each part for a specific vehicle.

# ATV - Application Listing

CC	Model	Year	Air Filter	Air Filter Precharger	Custom	Custom Precharger	Oil Filter	Comments
<b>YAMAHA</b>								
384	YFM400 Kodiak Auto 2x4	04	YA-3504	YA-3504PK			KN-303*	*Chrome=KN-303C
384	YFM400 Kodiak Auto 4x4	04-06	YA-3504	YA-3504PK			KN-303*	*Chrome=KN-303C
393	YFM400 Kodiak Auto 2x4	00-01	YA-4000				KN-303*	*Chrome=KN-303C
393	YFM400 Kodiak Auto 2x4	03	YA-4003	KA-3603PK			KN-303*	*Chrome=KN-303C
393	YFM400 Kodiak Auto 4x4	00-01	YA-4000				KN-303*	*Chrome=KN-303C
393	YFM400 Kodiak Auto 4x4	03	YA-4003	KA-3603PK			KN-303*	*Chrome=KN-303C
393	YFM400A Kodiak	02	YA-4000				KN-303*	*Chrome=KN-303C
393	YFM400F Kodiak	02	YA-4000				KN-303*	*Chrome=KN-303C
400	YFM400 Big Bear	01-03	YA-4001	YA-4001PK			KN-142	
400	YFM400 Big Bear 4x4	01-03	YA-4001	YA-4001PK			KN-142	
400	YFM400 Grizzly Auto 4x4	07-08	YA-3504	YA-3504PK			KN-204*	*Chrome=KN-204C
401	YFM400F Kodiak	93-99	YA-2597	YA-2597PK			KN-142	
416	YFM450 Kodiak Auto 4x4	04	YA-4003	KA-3603PK			KN-303*	*Chrome=KN-303C
416	YFM450 Kodiak Auto 4x4	05-06	YA-3504	YA-3504PK			KN-303*	*Chrome=KN-303C
449	YFZ450	04-06	YA-4504	YA-4504PK	63-1123	RX-4990DK	KN-141	
449	YFZ450	04-06	YA-4504	YA-4504PK	YA-4504-T	YA-4504-TDK	KN-141	
449	YFZ450	07-08	YA-4504	YA-4504PK	63-1123	RX-4990DK	KN-140	
449	YFZ450	07-09	YA-4504	YA-4504PK	YA-4504-T	YA-4504-TDK	KN-140	
449	YFZ450	09	YA-4504	YA-4504PK	63-1123*	RX-4990DK	KN-140	*Exc. F/I
449	YFZ450	12-13	YA-4504	YA-4504PK	YA-4504-T	YA-4504-TDK	KN-140	
449	YFZ450R	09-15	YA-4504	YA-4504PK			KN-140	
450	YFM450 Grizzly	13	YA-3504	YA-3504PK			KN-204*	*Chrome=KN-204C
450	YFM450 Grizzly Auto	12-14	YA-3504	YA-3504PK			KN-204*	*Chrome=KN-204C
450	YFM450 Grizzly Auto 4x4	07-09	YA-3504	YA-3504PK			KN-204*	*Chrome=KN-204C
450	YFM450 Grizzly Auto 4x4	11	YA-3504	YA-3504PK			KN-204*	*Chrome=KN-204C
450	YFM450FX Wolverine 4x4	06	YA-3504	YA-3504PK			KN-303*	*Chrome=KN-303C
450	YFM450FX Wolverine 4x4	07-08	YA-3504	YA-3504PK			KN-204*	*Chrome=KN-204C
450	YFM450FX Wolverine Auto 4x4	09-11	YA-3504	YA-3504PK			KN-204*	*Chrome=KN-204C
450	YXR450 Rhino Auto 4x4	06	YA-6504	YA-6504PK			KN-303*	*Chrome=KN-303C
450	YXR450 Rhino Auto 4x4	07-09	YA-6504	YA-6504PK			KN-204*	*Chrome=KN-204C
489	YFM450 Kodiak Auto 4x4	03	YA-4003	KA-3603PK			KN-303*	*Chrome=KN-303C
558	YFM550F Grizzly FI Auto 4x4	09-14	YA-7007				KN-204*	*Chrome=KN-204C
600	YFM600 Grizzly	98-01	YA-4350	YA-4350PK			KN-145	
660	YFM660 Grizzly	02-03	YA-6602	YA-4350PK			KN-303*	*Chrome=KN-303C
660	YFM660 Grizzly Auto 4x4	04-06	YA-6602	YA-4350PK			KN-303*	*Chrome=KN-303C
660	YFM660 Grizzly Auto 4x4	07-08	YA-6602	YA-4350PK			KN-204*	*Chrome=KN-204C
660	YFM660R Raptor	01-05	YA-6601	25-6601	YA-6601-T	YA-6601-TDK	KN-147	
660	YFM660R Raptor	01-05	YA-6601	YA-6601DK	YA-6601-T	YA-6601-TDK	KN-147	
660	YXR660 Rhino	04-06	YA-6504	YA-6504PK	63-1119	62-1300DK	KN-303*	*Chrome=KN-303C
660	YXR660 Rhino	04-06	YA-6504	YA-6504PK	63-1119	RX-3810DK	KN-303*	*Chrome=KN-303C
660	YXR660 Rhino	04-06	YA-6504	YA-6504PK	RK-3920*		KN-303**	*Clutch Filter Kit/ **Chrome=KN-303C
660	YXR660 Rhino	07	YA-6504	YA-6504PK	63-1119	62-1300DK	KN-204*	*Chrome=KN-204C
660	YXR660 Rhino	07	YA-6504	YA-6504PK	63-1119	RX-3810DK	KN-204*	*Chrome=KN-204C
660	YXR660 Rhino	07	YA-6504	YA-6504PK	RK-3920*		KN-204**	*Clutch Filter Kit/ **Chrome=KN-204C
686	YFM700F Grizzly FI Auto 4x4	07-15	YA-7007				KN-204*	*Chrome=KN-204C
686	YXR700 Rhino FI	08-11	YA-7008	YA-7008DK	63-1121	22-8049DK	KN-204*	*Chrome=KN-204C
700	YFM700 Raptor	13-15	YA-7006	RU-0520PK			KN-145	
700	YFM700R Raptor	06-09	YA-7006	RU-0520PK			KN-145	
700	YFM700R Raptor	11-16	YA-7006	RU-0520PK			KN-145	
700	YXR700 Rhino FI	12-13	YA-7008	YA-7008DK	63-1121	22-8049DK	KN-204*	*Chrome=KN-204C

2) Requires Two; 3) Requires Three; 4) Requires Four. The use of custom air filter requires removal of air box. Some custom filters and intakes are not legal for sale or use on any pollution controlled motor vehicle in California or states adopting California emission procedures. See knfilters.com for CARB status on each part for a specific vehicle.



If maximum horsepower is the objective, the selection of the correct filter is of paramount importance. Two factors dictate the ability of the air filter unit to flow the maximum amount of air into the engine, these being the shape and size. With a K&N® air filter, we can take the outside dimensions of the air filter as a means of selecting sufficient area for the air flow required.

Let us deal with shape first. K&N's air flow bench has shown that with typical two and four barrel automotive carburetors, air flow is greater when the diameter of the air filter is large in comparison to its height. This means that an air filter that is 10" in diameter and 2" high, will generally flow more air than an air filter which is 5" in diameter and 4" high. If space permits, you should choose an air filter where the height of the air filter is between 1/5 and 1/4 of the air filter's diameter. Another thing that the air flow bench has shown, is that there are exceptions to every rule. One such exception occurs when an air filter is clamped on a long runner used to feed a throttle body on an electronic fuel injected engine. The straighter the air can enter the tube, the lower the restriction will be. Hence, in order to let the air travel as straight as possible, a filter that has a height of 2 to 4 times its diameter will work best. On single throat carburetors or injector stacks where one air filter per throat is used, a taller air filter can also be used to an advantage. The diameter of the air filter in relation to the throat of the carburetor is important and generally the diameter of the air filter should be at least three times the diameter of the throat of the carburetor. When space does not permit the ideal filter shape, choose a size that will still allow enough airflow for the engine.

Once you have determined the shape of the filter required, the size of the filter must be selected. This is important. A filter that is too small can literally strangle an engine, in addition, if too small of a filter is used, the filtering efficiency drops dramatically due to the excessive speed of the incoming air actually opening up the passages in the cotton gauze. At K&N, we believe a pressure drop of 1.5" of water across the air filter element at maximum power RPM, is the most that should be used for sizing a new air filter.

Two factors dictate filter size: displacement of the engine in cubic centimeters (cc), and the RPM turned at maximum horsepower. The effective area of a filter is the diameter in inches x 3.1416 x the height of the air filter in inches, less .75". The reason we subtract the .75" is because of the rubber seals on the end of the filter, and the fact that very little air flows near them, so this part of the filter is not included.

To determine the minimum size of filter that is required for your application, apply the following formula (table 1):

Let us assume that we will put one filter for each carburetor for a total of 4 filters. The flange of the carburetors should be measured so that the proper size clamp-on filter can be found. In this case each carburetor has a 2 1/16" O.D. flange. The maximum diameter of each air filter should be determined next. The measurement between the centerline of each carburetor will be the maximum diameter possible. Any frame, tubes, or other obstructions may further reduce the diameter possible. For ease of carburetor calibration, always use 4 filters of the same size. So if the measurements are 3.4", 3.7", 3.4", but there is a frame tube that will interfere on the outer carburetors at 1.5", the maximum diameter that all 4 filters can be, is 3.0", because of the frame interference. (table 2).

Now the filter element height can be calculated from the formula (table 3):

Referencing the specialty air filter section will show a couple of choices that will be acceptable for this application. We can use an RU-1880 which is 3" O.D. x 2 1/2" long with a rubber top. RC-1880 has the same dimensions but with a chrome top. And finally there is RC-1890 which has a length of 3" and a chrome top. This would be the best choice if the longer length will fit on the bike, because the service interval will be lengthened.

2) Engine: 1100cc 4 cylinder, 4 stroke motorcycle engine installed in an off-road dune buggy. The redline of the engine is 10,000 RPM (table 4):

In this situation, it would be better to use a single air filter, remotely mounted so that it may be changed easily if necessary. This will require custom fabrication of some tubing duct-work to hook up to the carburetors and allow a single large clamp-on filter to be installed. Let's say we will use 4" O.D. tubing to connect our filter to the carburetors. This will require a filter with a 4" flange. We will use 6" as our O.D. (table 5):

For off-road conditions, the filter should be 1.5 to 2 times the minimum, to allow more surface area for the dirt to build up on. Therefore the filter required will be 3.21-4.28 inches tall. Checking the specialty air filter section, we come up with RE-0870, which is a tapered clamp-on, 6" O.D. on the base and 4 5/8" O.D. on the top, with a filter length of 9" (in off-road air filters, bigger is better).

For a vehicle of any other sort, an air filter element about the size dictated by the formula will probably do the job. The formula will usually give an odd size for an answer. You should always select a larger size. The larger the air filter, the longer you can go before servicing is required.

### CONCLUSIONS

K&N air filters are designed to provide high air flow while at the same time providing the protection needed to ensure long engine life. A walk through the pits at an off-road race will show the numerous K&N filters installed on competitive and class-winning machines. A look at these same filters after the race will show a considerable amount of dirt on the outside of the filter, yet the inside will be as clean as a new filter (provided the filter was serviced and the case was sealed properly), and that's the way it should be. Whether you are racing to win or just driving to work, you can't afford to be without a K&N High-Flow Air Filter™!

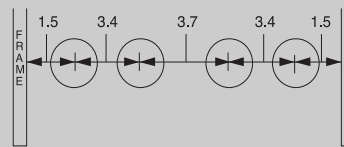

Table 2

$$H = \frac{A / \# \text{ of filters}}{D \times 3.14} + .75$$

Plugging in the numbers, we have:

$$H = \frac{15.8 / 4}{3 \times 3.14} + .75 = 1.16''$$

Table 3

$$A = \frac{1100 \times 10,000}{85,381 \times 4} = 32.2 \text{ sq. in.}$$

Table 4

$$H = \frac{26.3 / 1}{2.14''} + .75 = 6 \times 3.14$$

Table 5

$$A = \frac{\text{cc} \times \text{RPM}}{85,381 \times \text{stroke type}}$$

A = effective filtering area  
 cc = cubic centimeter displacement  
 RPM = redline of engine  
 Stroke type = 2 or 4

To find the total height (including the rubber sealing edges) of the filter needed, apply this formula:

$$H = \frac{A / \# \text{ of filters}}{D \times 3.14} + .75$$

D = estimated maximum diameter that will fit unobstructed in the vehicle.  
 H = height of filter

To make things clear, study these two examples:

1) Engine: 600cc 4-cylinder, 4-stroke, with 4 carburetors and a redline of 11,000 rpm, in a street bike.

$$A = \frac{\text{cc} \times \text{RPM}}{85,381 \times \text{stroke type}}$$

Applying the formula for filter area, we have:

$$A = \frac{600 \times 11,000}{85,381 \times 4} = 15.8 \text{ sq. inches}$$

Table 1

# Round Straight

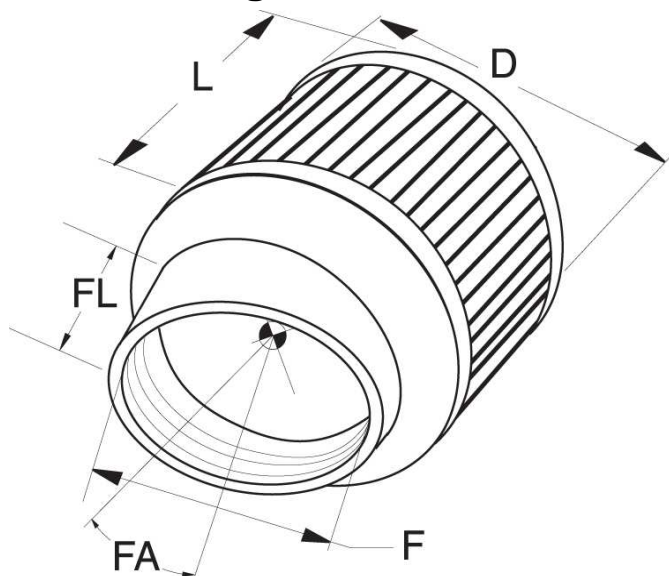

When selecting one of K&N's universal round straight air filters, you should consider the following dimensions as they relate to the specification chart:

(F) Mounting Flange Inside Diameter - This is the most critical dimension and should be very close to the diameter of the application's inlet flange. The flange will stretch up to 1/16" for those in-between sizes.

(D) Filter Diameter - This is the overall diameter of the filter. Always use the largest diameter practical for maximum filtration.

(L) Filter Length - This dimension is the length of the filter body only, it does not include the flange length. Always use the longest filter practical for maximum filtration.

(FA/FL) Flange Angle and/or Length - If no angle is listed in the specifications table, then the flange is straight. Any angle listed is in degrees and can be utilized when space is a problem.

(FO) Flange Offset - In some cases the center of the flange is offset from the center of the filter base in order to provide a better fit.

(F) Mounting Flange Inside Diameter		(D) Filter Diameter		(L) Filter Length		(FL) Flange Length		(FA) Flange Style		(FO) Flange Offset		Rubber End Cap Part #	Chrome End Cap Part #	Custom End Cap Part #	Filter Wraps Part #	
Inch	mm	Inch	mm	Inch	mm	Inch	mm	Type	Angle	Inch	mm					
5/16	8	1-3/8	35	1-1/8	29	7/16	11	Centered							62-2470	
3/8	10	2	51	1-1/2	38	3/8	10	Centered							62-1570 <sup>28</sup>	
		2	51	1-1/2	38	7/16	11	Centered				62-1320				
		2	51	1-3/4	44	1/2	13	Centered					62-1600WT-			
		2	51	1-3/4	44	5	127	Centered					62-1600RD-			
1/2	13	2	51	1-1/2	38	7/16	11	Centered						62-1330		
11/20	14	1-3/8	35	1-1/8	29	219/500	11	Centered						62-2480		
9/16	14	2	51	2-1/8	54	1	25	Centered						62-1230		
5/8	16	1-3/8	35	1-1/8	29	3/8	10	Centered				RU-3230				
		2	51	1-1/2	38	7/16	11	Centered					62-1340			
3/4	19	1-3/8	35	1-1/8	29	7/16	11	Centered				62-1560				
		2	51	1-1/2	38	7/16	11	Centered						62-1360		
		2	51	2-1/2	64	5/8	16	Centered				RU-3630				
1	25	2	51	1-1/2	38	5/8	16	Centered						62-1370		
		3	76	2-1/4	57	5/8	16	Centered						62-1420		RU-0150PK
		3	76	2-3/8	60	7/16	11	Centered				62-1410				RU-0150PK
1-1/16	27	3	76	3	76	5/8	16	Centered			R-1040				22-8008PK	
1-1/4	32	3	76	2-1/2	64	5/8	16	Centered							62-1580	
		3	76	2-1/2	64	5/8	16	Centered				62-1380			RU-0150PK	
		3	76	2-1/2	64	7/8	22	Centered						62-1390	RU-0150PK	
		3	76	3	76	5/8	16	Centered				RU-0060				22-8008PK
		3	76	4	102	5/8	16	Centered				RU-0070				22-8009PK
		3	76	4	102	3/4	19	Angled	20°			RU-0100				22-8009PK
1-3/8	35	3	76	5	127	5/8	16	Centered				RU-0080				RU-0210PK
		3	76	5	127	3/4	19	Angled	20°			RU-0110				RU-0210PK
		3	76	2-1/2	64	7/16	11	Centered						62-1440		RU-0150PK

1) 1/4-20 Jack Nut Into Top 2) Base Has (2) 7/8" Vents 3) Base Has 1/2" Vent 4) Base Has 1/32" Vent 5) Base Has 1/4" Vent 6) Base Has 11/16" Vent 7) Base Has 1-1/8" Vent 8) Base Has 13/16" Vent 9) Base Has 13/32" Vent 10) Base Has 13/64" Vent 11) Base Has 2-3/16" Square Inlet 12) Base Has 15/64" Vent 13) Base Has 19/32" Vent 14) Base Has 21/32" Vent 15) Base Has 25/64" Vent 16) Base Has 29/32" Vent 17) Base Has 3/16" Vent 18) Base Has 3/4" Vent 19) Base Has 3/8" Vent 20) Base Has 31/64" Vent 21) Base Has 35/64" Vent 22) Base Has 45/64" Vent 23) Base Has 5/16" Vent 24) Base Has 5/8" Vent 25) Base Has 55/64" Vent 26) Base Has 7/16" Vent 27) Base Has 7/8" Vent 28) Base Has 9/16" Vent 29) Base Has Opt. 1/2" Vent 30) Base Has 23/32" Vent 31) Base Has 25/32" Vent 32) Filter Has Molded-in Velocity Stack 33) Filter Is Reverse Tapered 34) Fits Legend/Dwarf Race Cars w/FJ1200 Motors 35) Base Has 15/32" Vent 36) Top Plate Has 1/4-20 Stud 37) Top-Plate Has 6MM Stud 39) Offset Is Vertical 41) Offset Is Vertical And To The Right 42) Top Has 1/2" Vent 43) Top Has 1-1/16" Center Hole 44) Top Has 21/32" Center Hole 45) Top Has 23/32" Center Hole 46) Top Has 5/32" Center Hole 47) Top Has 7/16" Center Hole 48) Base Has 11/32" Vent 49) Top Has 1/4" Center Hole 50) Top Has 1-7/16" Center Hole 51) 2-1/2" Adapter Included 52) Top Has 5/8" Vent 53) Tapered Insert Included 5" to 4-3/8" 54) Filter Has Thru Hole 2-3/4" x 1-5/8"

# Round Straight

(F) Mounting Flange Inside Diameter		(D) Filter Diameter		(L) Filter Length		(FL) Flange Length		(FA) Flange Style		(FO) Flange Offset		Rubber End Cap Part #	Chrome End Cap Part #	Custom End Cap Part #	Filter Wraps Part #
Inch	mm	Inch	mm	Inch	mm	Inch	mm	Type	Angle	Inch	mm				
1-3/8	35	3	76	2-1/2	64	5/8	16	Centered				62-1430			RU-0150PK
1-1/2	38	3	76	2-1/2	64	7/16	11	Centered					62-1460		RU-0150PK
		3	76	2-1/2	64	5/8	16	Centered				62-1450			RU-0150PK
		3	76	3	76	5/8	16	Centered				RU-0155			
		3	76	4	102	5/8	16	Centered				RU-0160			22-8009PK
		3	76	6	152	5/8	16	Centered				RU-0175			
1-9/16	40	3	76	2	51	5/8	16	Centered					RC-0840		RU-0150PK
		3	76	2-1/4	57	5/8	16	Centered					RC-0880		RU-0150PK
		3	76	2-1/2	64	5/8	16	Centered				RU-2310	RC-0160		RU-0150PK
		3	76	3	76	5/8	16	Centered					RC-0870		22-8008PK
		3-1/2	89	1-1/2	38	5/8	16	Centered					RC-0170		RC-0170DK
1-11/16	43	3	76	2-1/2	64	5/8	16	Centered				RU-1130	RC-1130		RU-0150PK
		3	76	3	76	5/8	16	Centered					RC-1120		22-8008PK
		3	76	4	102	5/8	16	Centered				RU-0200			22-8009PK
		3	76	5	127	5/8	16	Centered				RU-0210			RU-0210PK
		3	76	6	152	1-1/2	38	Angled	40°			R-1030			22-8010PK
		3-1/2	89	2	51	5/8	16	Centered					RC-0190		
		3-1/2	89	10	254	5/8	16	Centered				RU-3850			25-3918
		4	102	2	51	5/8	16	Centered				RU-0260			
		5-1/4	133	2	51	5/8	16	Offset		3/4	19	RU-0310			
1-3/4	44	3	76	2	51	5/8	16	Centered				RU-2570			RU-0150PK
		3	76	2-1/2	64	5/8	16	Centered				62-1470		62-1480	RU-0150PK
		3	76	3	76	5/8	16	Centered				RU-2685			
		3	76	6	152	5/8	16	Centered				RU-2575			
		3-1/2	89	1-1/2	38	5/8	16	Centered					RC-2870		RC-0170DK
		3-1/2	89	4-1/2	114	1	25	Angled	10°			RU-1030			RU-0510PK
		3-1/2	89	5	127	5/8	16	Centered				RU-0360			25-1770
		3-1/2	89	5	127	3/4	19	Angled	10°			RU-1040			25-1770
		3-1/2	89	6	152	5/8	16	Centered				R-1050			25-1770
		3-1/2	89	6	152	3/4	19	Angled	10°			RU-1050			RU-0520PK
		4-1/2	114	1-1/2	38	5/8	16	Offset		9/16	14		RC-0330		25-0330
		4-1/2	114	1-1/2	38	5/8	16	Centered				RU-0340	RC-0340		25-0330
		4-1/2	114	2	51	5/8	16	Centered				RU-0370	RC-0370		
1-13/16	46	3	76	2-1/4	57	5/8	16	Centered					RC-0910		RU-0150PK
		3	76	2-1/4	57	1	25	Centered					RC-2620		RU-0150PK
		3	76	3	76	5/8	16	Centered					RC-0890		22-8008PK
		5-1/2	140	3	76	5/8	16	Offset		15/16	24	RU-0350			22-8015PK
1-7/8	48	3	76	1-1/2	38	5/8	16	Centered				RU-2560			
		3	76	2	51	5/8	16	Centered				RU-3350			RU-0150PK
		3	76	4	102	5/8	16	Centered				RU-0400			22-8009PK
		3	76	4	102	1	25	Angled	10°			RU-1280	RC-1280		22-8009PK
		3	76	5	127	5/8	16	Centered				RU-0410	RC-0410		RU-0210PK
		3	76	6	152	5/8	16	Centered				RU-0420			22-8010PK
		3-1/2	89	4	102	5/8	16	Centered				RD-0450			RU-0500PK
		3-1/2	89	5	127	5/8	16	Centered				RD-0460			25-1770

1) 1/4-20 Jack Nut Into Top 2) Base Has (2) 7/8" Vents 3) Base Has 1/2" Vent 4) Base Has 1/32" Vent 5) Base Has 1/4" Vent 6) Base Has 11/16" Vent 7) Base Has 1-1/8" Vent 8) Base Has 13/16" Vent 9) Base Has 13/32" Vent 10) Base Has 13/64" Vent 11) Base Has 2-3/16" Square Inlet 12) Base Has 15/64" Vent 13) Base Has 19/32" Vent 14) Base Has 21/32" Vent 15) Base Has 25/64" Vent 16) Base Has 29/32" Vent 17) Base Has 3/16" Vent 18) Base Has 3/4" Vent 19) Base Has 3/8" Vent 20) Base Has 31/64" Vent 21) Base Has 35/64" Vent 22) Base Has 45/64" Vent 23) Base Has 5/16" Vent 24) Base Has 5/8" Vent 25) Base Has 55/64" Vent 26) Base Has 7/16" Vent 27) Base Has 7/8" Vent 28) Base Has 9/16" Vent 29) Base Has Opt. 1/2" Vent 30) Base Has 23/32" Vent 31) Base Has 25/32" Vent 32) Filter Has Molded-in Velocity Stack 33) Filter Is Reverse Tapered 34) Fits Legend/Dwarf Race Cars w/F1200 Motors 35) Base Has 15/32" Vent 36) Top Plate Has 1/4-20 Stud 37) Top Plate Has 6MM Stud 39) Offset Is Vertical 41) Offset Is Vertical And To The Right 42) Top Has 1/2" Vent 43) Top Has 1-1/16" Center Hole 44) Top Has 21/32" Center Hole 45) Top Has 23/32" Center Hole 46) Top Has 5/32" Center Hole 47) Top Has 7/16" Center Hole 48) Base Has 11/32" Vent 49) Top Has 1/4" Center Hole 50) Top Has 1-7/16" Center Hole 51) 2-1/2" Adapter Included 52) Top Has 5/8" Vent 53) Tapered Insert Included 5" to 4-3/8" 54) Filter has Thru Hole 2-3/4" x 1-5/8"

# Round Straight

(F) Mounting Flange Inside Diameter		(D) Filter Diameter		(L) Filter Length		(FL) Flange Length		(FA) Flange Style		(FO) Flange Offset		Rubber End Cap Part #	Chrome End Cap Part #	Custom End Cap Part #	Filter Wraps Part #	
Inch	mm	Inch	mm	Inch	mm	Inch	mm	Type	Angle	Inch	mm					
1-7/8	48	3-1/2	89	6	152	5/8	16	Centered				RD-0470			25-1770	
1-15/16	49	3	76	2	51	5/8	16	Centered				RU-2700			RU-0150PK	
		3	76	2-1/2	64	5/8	16	Centered				RU-2760			RU-0150PK	
		3	76	3	76	5/8	16	Centered				RP-5164			22-8008PK	
		3	76	4	102	5/8	16	Centered				RP-5119			22-8009PK	
		3-1/2	89	4	102	2	51	Angled	20°				RU-1400			RU-0500PK
		3-1/2	89	5	127	2	51	Angled	20°				RU-1410			25-1770
		3-1/2	89	6	152	2	51	Angled	20°			RU-1420			25-1770	
2	51	5-1/8	130	2	51	11/16	17	Offset		1	25		RC-2400			
		5-3/8	137	2	51	5/8	16	Centered					RC-2440			
		7	178	9	229	5/8	16	Centered					41-1000 <sup>2</sup>		22-8022PK	
2-1/16	52	3	76	2-1/2	64	5/8	16	Centered				RU-1880	RC-1880		RU-0150PK	
		3	76	3	76	5/8	16	Centered					RC-1890		22-8008PK	
		3-1/2	89	3	76	5/8	16	Centered					RC-1150			
		3-1/2	89	4	102	5/8	16	Centered					RU-0500	RC-0500		RU-0500PK
		3-1/2	89	4	102	7/8	22	Centered					RA-0500			RU-0500PK
		3-1/2	89	5	127	5/8	16	Centered					RU-0510			25-1770
		3-1/2	89	5	127	3/4	19	Angled	10°				RU-1060			25-1770
		3-1/2	89	5	127	7/8	22	Centered					RA-0510			25-1770
		3-1/2	89	5	127	2-1/2	64	Angled	17°				RU-1780			25-1770
		3-1/2	89	6	152	5/8	16	Centered					RU-0520			25-1770
		3-1/2	89	6	152	3/4	19	Angled	10°				RU-1070			25-1770
		3-1/2	89	6	152	7/8	22	Centered					RA-0520			25-1770
		4-1/2	114	4	102	7/8	22	Centered					RA-0530			22-8012PK
		4-1/2	114	5	127	7/8	22	Centered					RA-0540			22-8013PK
2-1/8	54	3	76	3	76	5/8	16	Centered					RC-1910		22-8008PK	
		3-1/2	89	4	102	7/8	22	Centered				RD-0500			RU-0500PK	
		3-1/2	89	4	102	1	25	Angled	5°			RB-0500			RU-0500PK	
		3-1/2	89	5	127	7/8	22	Centered				RD-0510			25-1770	
		3-1/2	89	5	127	1	25	Angled	5°			RB-0510	RC-0510		RA-0510DB	
		3-1/2	89	6	152	7/8	22	Centered				RD-0520			25-1770	
		3-1/2	89	6	152	1	25	Angled	5°			RB-0520			25-1770	
		3-1/2	89	4	102	1	25	Angled	20°				RU-1700			RU-0500PK
2-1/4	57	3-1/2	89	1-1/4	32	5/8	16	Centered					RC-2880		RC-0170DK	
		3-1/2	89	2	51	5/8	16	Centered					RC-1900			
		3-1/2	89	4	102	5/8	16	Centered				RU-0600			RU-0500PK	
		3-1/2	89	4	102	1	25	Angled	5°			RB-0600			RU-0500PK	

1) 1/4-20 Jack Nut Into Top 2) Base Has (2) 7/8" Vents 3) Base Has 1/2" Vent 4) Base Has 1/32" Vent 5) Base Has 1/4" Vent 6) Base Has 11/16" Vent 7) Base Has 1-1/8" Vent 8) Base Has 13/16" Vent 9) Base Has 13/32" Vent 10) Base Has 13/64" Vent 11) Base Has 2-3/16" Square Inlet 12) Base Has 15/64" Vent 13) Base Has 19/32" Vent 14) Base Has 21/32" Vent 15) Base Has 25/64" Vent 16) Base Has 29/32" Vent 17) Base Has 3/16" Vent 18) Base Has 3/4" Vent 19) Base Has 3/8" Vent 20) Base Has 31/64" Vent 21) Base Has 35/64" Vent 22) Base Has 45/64" Vent 23) Base Has 5/16" Vent 24) Base Has 5/8" Vent 25) Base Has 55/64" Vent 26) Base Has 7/16" Vent 27) Base Has 7/8" Vent 28) Base Has 9/16" Vent 29) Base Has Opt. 1/2" Vent 30) Base Has 23/32" Vent 31) Base Has 25/32" Vent 32) Filter Has Molded-in Velocity Stack 33) Filter Is Reverse Tapered 34) Fits Legend/Dwarf Race Cars w/FJ1200 Motors 35) Base Has 15/32" Vent 36) Top Plate Has 1/4-20 Stud 37) Top Plate Has 6MM Stud 39) Offset Is Vertical 41) Offset Is Vertical And To The Right 42) Top Has 1/2" Vent 43) Top Has 1-1/16" Center Hole 44) Top Has 21/32" Center Hole 45) Top Has 23/32" Center Hole 46) Top Has 5/32" Center Hole 47) Top Has 7/16" Center Hole 48) Base Has 11/32" Vent 49) Top Has 1/4" Center Hole 50) Top Has 1-7/16" Center Hole 51) 2-1/2" Adapter Included 52) Top Has 5/8" Vent 53) Tapered Insert Included 5" to 4-3/8" 54) Filter has Thru Hole 2-3/4" x 1-5/8"

# Round Straight

(F) Mounting Flange Inside Diameter		(D) Filter Diameter		(L) Filter Length		(FL) Flange Length		(FA) Flange Style		(FO) Flange Offset		Rubber End Cap Part #	Chrome End Cap Part #	Custom End Cap Part #	Filter Wraps Part #
Inch	mm	Inch	mm	Inch	mm	Inch	mm	Type	Angle	Inch	mm				
2-1/4	57	3-1/2	89	5	127	5/8	16	Centered				RU-0610			25-1770
		3-1/2	89	5	127	3/4	19	Angled	10°			RU-1080			25-1770
		3-1/2	89	5	127	1	25	Angled	5°			RB-0610			25-1770
		3-1/2	89	5	127	1	25	Angled	20°			RU-1710			25-1770
		3-1/2	89	6	152	5/8	16	Centered				RU-0620			25-1770
		3-1/2	89	6	152	3/4	19	Angled	10°			RU-1090			25-1770
		3-1/2	89	6	152	1	25	Angled	5°			RB-0620			25-1770
		3-1/2	89	6	152	1	25	Angled	20°			RU-1720			25-1770
		3-1/2	89	10	254	5/8	16	Centered				RU-3840			25-3918
		4-1/2	114	2	51	5/8	16	Offset		5/16	8		RC-1950		
		4-1/2	114	4	102	5/8	16	Centered				RU-0630			22-8012PK
		4-1/2	114	5	127	5/8	16	Centered				RU-0640			22-8013PK
		5-1/2	140	2-1/2	64	5/8	16	Offset		13/16	21	RU-0650	RC-0650		
		5-1/2	140	3	76	5/8	16	Offset		13/16	21	RU-0660			22-8015PK
		5-1/2	140	3-1/2	89	5/8	16	Centered				RU-0690			
		5-1/2	140	5	127	5/8	16	Offset		13/16	21	RU-0680			22-8016PK
		7	178	9	229	5/8	16	Centered					41-1100 <sup>2</sup>		22-8022PK
2-3/8	60	4-7/16	113	6-1/16	154	3/4	19	Centered				CM-8012			
2-7/16	62	3-1/2	89	4	102	5/8	16	Centered				RU-0800			RU-0500PK
		3-1/2	89	5	127	5/8	16	Centered				RU-0810			25-1770
		3-1/2	89	6	152	5/8	16	Centered				RU-0820 <sup>4</sup>			25-1770
		3-1/2	89	6	152	1-1/8	29	Centered				RU-3030			25-1770
		3-3/4	95	2	51	2	51	Angled	20°			RU-1730			
		3-3/4	95	4	102	2	51	Angled	20°			RU-1750			22-8011PK
		3-3/4	95	5	127	2	51	Angled	20°			RU-1760			RU-1460PK
		3-3/4	95	6	152	2	51	Angled	20°			RU-1770			RU-1470PK
		4	102	4-3/4	121	3/4	19	Centered						RX-4040-1 <sup>1,15</sup>	
		4-1/2	114	4	102	5/8	16	Centered				RU-0830			22-8012PK
		4-1/2	114	5	127	5/8	16	Centered				RU-0840			22-8013PK
		5	127	3	76	5/8	16	Centered					RC-0860		22-8015PK
		5-1/8	130	2	51	5/8	16	Centered					RC-0850		
		5-1/2	140	3	76	5/8	16	Offset		1/2	13	RU-0870			22-8015PK
		5-1/2	140	4	102	5/8	16	Offset		1/2	13	RU-0880			
		5-1/2	140	6	152	5/8	16	Offset		1/2	13	RU-1000			22-8045DK
2-1/2	64	3-1/2	89	4	102	5/8	16	Centered				RD-0700			RU-0500PK
		3-1/2	89	4	102	1	25	Angled	5°			RB-0700			RU-0500PK
		3-1/2	89	5	127	5/8	16	Centered				RD-0710			25-1770
		3-1/2	89	5	127	1	25	Angled	5°			RB-0710			25-1770
		3-1/2	89	6	152	5/8	16	Centered				RD-0720			25-1770
		3-1/2	89	6	152	1	25	Angled	5°			RB-0720			25-1770
		5-9/16	141	6	152	3/4	19	Centered				PL-3214			PL-3214DK
		7	178	9	229	5/8	16	Centered					41-1200 <sup>2</sup>		22-8022PK
2-9/16	65	4-1/2	114	4	102	3/4	19	Centered				RA-0600			22-8012PK
		4-1/2	114	5	127	3/4	19	Centered				RA-0610			22-8013PK
		5-1/2	140	2	51	3/4	19	Centered				RA-0620 <sup>5</sup>	RA-062V <sup>5</sup>		

1) 1/4-20 Jack Nut Into Top 2) Base Has (2) 7/8" Vents 3) Base Has 1/2" Vent 4) Base Has 1/32" Vent 5) Base Has 1/4" Vent 6) Base Has 11/16" Vent 7) Base Has 1-1/8" Vent 8) Base Has 13/16" Vent 9) Base Has 13/32" Vent 10) Base Has 13/64" Vent 11) Base Has 2-3/16" Square Inlet 12) Base Has 15/64" Vent 13) Base Has 19/32" Vent 14) Base Has 21/32" Vent 15) Base Has 25/64" Vent 16) Base Has 29/32" Vent 17) Base Has 3/16" Vent 18) Base Has 3/4" Vent 19) Base Has 3/8" Vent 20) Base Has 31/64" Vent 21) Base Has 35/64" Vent 22) Base Has 45/64" Vent 23) Base Has 5/16" Vent 24) Base Has 5/8" Vent 25) Base Has 55/64" Vent 26) Base Has 7/16" Vent 27) Base Has 7/8" Vent 28) Base Has 9/16" Vent 29) Base Has Opt. 1/2" Vent 30) Base Has 23/32" Vent 31) Base Has 25/32" Vent 32) Filter Has Molded-in Velocity Stack 33) Filter Is Reverse Tapered 34) Fits Legend/Dwarf Race Cars w/FJ1200 Motors 35) Base Has 15/32" Vent 36) Top Plate Has 1/4-20 Stud 37) Top-Plate Has 6MM Stud 39) Offset Is Vertical 41) Offset Is Vertical And To The Right 42) Top Has 1/2" Vent 43) Top Has 1-1/16" Center Hole 44) Top Has 21/32" Center Hole 45) Top Has 23/32" Center Hole 46) Top Has 5/32" Center Hole 47) Top Has 7/16" Center Hole 48) Base Has 11/32" Vent 49) Top Has 1/4" Center Hole 50) Top Has 1-7/16" Center Hole 51) 2-1/2" Adapter Included 52) Top Has 5/8" Vent 53) Tapered Insert Included 5" to 4-3/8" 54) Filter has Thru Hole 2-3/4" x 1-5/8"

# Round Straight

(F) Mounting Flange Inside Diameter		(D) Filter Diameter		(L) Filter Length		(FL) Flange Length		(FA) Flange Style		(FO) Flange Offset		Rubber End Cap Part #	Chrome End Cap Part #	Custom End Cap Part #	Filter Wraps Part #
Inch	mm	Inch	mm	Inch	mm	Inch	mm	Type	Angle	Inch	mm				
2-9/16	65	5-1/2	140	3	76	3/4	19	Centered				RA-0630 <sup>5</sup>	RA-063V <sup>5</sup>		22-8015PK
		5-1/2	140	4	102	3/4	19	Centered				RA-0640 <sup>5</sup>			
		5-1/2	140	5	127	3/4	19	Centered				RA-0650 <sup>5</sup>			22-8016PK
		5-7/8	149	3	76	7/8	22	Offset		13/16	21		RA-067V <sup>5</sup>		
		5-7/8	149	4	102	7/8	22	Offset		13/16	21	RA-0680 <sup>5</sup>			
		6	152	2	51	7/8	22	Offset		13/16	21	RA-0660 <sup>5</sup>	RA-066V <sup>5</sup>		22-8017PK
		6	152	3	76	7/8	22	Offset		13/16	21	RA-0670 <sup>5</sup>			
		6	152	4	102	7/8	22	Offset		13/16	21		RA-068V <sup>5</sup>		
2-5/8	67	4	102	2-1/4	57	1/2	13	Centered						60-0410	
		4	102	4	102	1	25	Angled	5°			RB-0800			22-8011PK
		4	102	5	127	1	25	Angled	5°			RB-0810			25-1770
		4-1/2	114	2	51	5/8	16	Centered				RU-2630			
		4-1/2	114	3	76	5/8	16	Centered				RU-2640			
		4-1/2	114	4	102	5/8	16	Centered				RU-2650			22-8012PK
2-11/16	68	4-1/16	103	7	178	3/4	19	Centered				RX-5032			
		4-1/2	114	4	102	5/8	16	Centered				RU-0900			22-8012PK
		4-1/2	114	5	127	5/8	16	Centered				RU-0910			22-8013PK
2-3/4	70	4	102	5	127	1	25	Angled	10°			RU-1460			RU-1460PK
		4	102	6	152	1	25	Angled	10°			RU-1470			25-1770
		4	102	6	152	2	51	Angled	20°			RU-3190			25-1770
		4	102	7	178	1	25	Angled	10°			RU-1480			RU-1480PK
		5-1/8	130	2	51	5/8	16	Centered					RC-0920		
		5-1/8	130	3	76	5/8	16	Centered					RC-0930		22-8015PK
		5-1/2	140	3	76	5/8	16	Offset		7/16	11	RU-0940			22-8015PK
		5-1/2	140	4	102	5/8	16	Offset		7/16	11	RU-0950			
		5-1/2	140	5	127	5/8	16	Offset		7/16	11	RU-0960			22-8016PK
		7	178	3	76	5/8	16	Offset		11/16	17	RU-0980			RU-0980PK
		7	178	7	178	5/8	16	Offset		11/16	17	RU-2940			25-3900
2-7/8	73	4	102	5-3/8	137	5/8	16	Centered				RU-2410			25-3900
		4	102	6	152	5/8	16	Centered				RU-1620			25-1770
		4-1/2	114	5	127	5/8	16	Centered				RU-3710	RC-3710		HA-3094PR
		4-1/2	114	6-1/8	156	5/8	16	Centered				E-1989			RX-3820PK
		4-7/8	124	7-1/4	184	11/16	17	Centered				E-1988			
2-29/32	74	4-15/16	125	5-29/32	150	11/16	17	Centered					RC-9070		
3	76	4-5/16	110	4	102	1	25	Angled	5°			RB-0900			22-8012PK
		4-5/16	110	5	127	1	25	Angled	5°			RB-0910			22-8013PK
		5	127	3	76	5/8	16	Centered				RU-2420			22-8015PK
		5	127	5	127	5/8	16	Centered				RU-2430		RC-5182XD	RU-2430PK
		5	127	6-1/2	165	5/8	16	Centered				RU-2820			22-8044PK
		5	127	7	178	5/8	16	Centered						RX-2820 <sup>15</sup>	22-8044PK
		5	127	9	229	5/8	16	Centered					RC-2530 <sup>2,33</sup>		25-3918
		7	178	2	51	5/8	16	Offset		7/8	22	RA-0970 <sup>4</sup>	RA-097V <sup>4</sup>		
		7	178	3	76	5/8	16	Offset		7/8	22	RA-0980 <sup>4</sup>	RA-098V <sup>4</sup>		RU-0980PK
		7	178	3	76	1-1/8	29	Offset		1-1/16	27		RC-3140		RU-0980PK
		7	178	4	102	5/8	16	Offset		7/8	22	RA-0990 <sup>4</sup>	RA-099V <sup>4</sup>		22-8019PK

1) 1/4-20 Jack Nut Into Top 2) Base Has (2) 7/8" Vents 3) Base Has 1/2" Vent 4) Base Has 1/32" Vent 5) Base Has 1/4" Vent 6) Base Has 11/16" Vent 7) Base Has 1-1/8" Vent 8) Base Has 13/16" Vent 9) Base Has 13/32" Vent 10) Base Has 13/64" Vent 11) Base Has 2-3/16" Square Inlet 12) Base Has 15/64" Vent 13) Base Has 19/32" Vent 14) Base Has 21/32" Vent 15) Base Has 25/64" Vent 16) Base Has 29/32" Vent 17) Base Has 3/16" Vent 18) Base Has 3/4" Vent 19) Base Has 3/8" Vent 20) Base Has 31/64" Vent 21) Base Has 35/64" Vent 22) Base Has 45/64" Vent 23) Base Has 5/16" Vent 24) Base Has 5/8" Vent 25) Base Has 55/64" Vent 26) Base Has 7/16" Vent 27) Base Has 7/8" Vent 28) Base Has 9/16" Vent 29) Base Has Opt. 1/2" Vent 30) Base Has 23/32" Vent 31) Base Has 25/32" Vent 32) Filter Has Molded-in Velocity Stack 33) Filter Is Reverse Tapered 34) Fits Legend/Dwarf Race Cars w/F1J200 Motors 35) Base Has 15/32" Vent 36) Top Plate Has 1/4-20 Stud 37) Top Plate Has 6MM Stud 39) Offset Is Vertical 41) Offset Is Vertical And To The Right 42) Top Has 1/2" Vent 43) Top Has 1-1/16" Center Hole 44) Top Has 21/32" Center Hole 45) Top Has 23/32" Center Hole 46) Top Has 5/32" Center Hole 47) Top Has 7/16" Center Hole 48) Base Has 11/32" Vent 49) Top Has 1/4" Center Hole 50) Top Has 1-7/16" Center Hole 51) 2-1/2" Adapter Included 52) Top Has 5/8" Vent 53) Tapered Insert Included 5" to 4-3/8" 54) Filter has Thru Hole 2-3/4" x 1-5/8"

# Round Straight

(F) Mounting Flange Inside Diameter		(D) Filter Diameter		(L) Filter Length		(FL) Flange Length		(FA) Flange Style		(FO) Flange Offset		Rubber End Cap Part #	Chrome End Cap Part #	Custom End Cap Part #	Filter Wraps Part #
Inch	mm	Inch	mm	Inch	mm	Inch	mm	Type	Angle	Inch	mm				
3	76	7	178	6	152	1	25	Centered					RD-1300		22-8021PK
3-1/16	78	6-7/8	175	5-15/16	151	9/16	14	Centered				RU-9040			
		7	178	3	76	5/8	16	Centered				RA-0950 <sup>4</sup>	RA-095V <sup>4</sup>		RU-0980PK
		7	178	4	102	5/8	16	Centered				RA-0960 <sup>4</sup>	RA-096V <sup>4</sup>		22-8019PK
		7	178	6	152	5/8	16	Centered				RU-9004			22-8021PK
3-1/8	79	5	127	1-7/8	48	3/4	19	Offset		1	25	YA-6598			
		6	152	4-1/4	108	5/8	16	Centered				E-2996			
3-5/16	84	5-3/8	137	6-3/16	157	5/8	16	Centered				E-1998			
		5-13/16	148	7-1/4	184	3/4	19	Centered				E-0774			
3-3/8	86	5-13/16	148	7-1/4	184	5/8	16	Centered				E-1009			
3-1/2	89	5	127	3	76	5/8	16	Centered				RU-1790	RC-1790		22-8015PK
		5	127	5-5/8	143	5/8	16	Centered				RU-5114			CM-4508DK
		5	127	8-1/2	216	5/8	16	Centered				RU-1785			
3-17/32	90	4	102	5-31/32	152	23/32	18	Centered						RX-4140 <sup>15</sup>	RU-1470PK
3-5/8	92	5-13/16	148	7-1/4	184	3/4	19	Centered				E-0773			
4	102	6-1/4	159	6	152	13/16	21	Centered				E-1996			
		6-1/4	159	7-3/4	197	13/16	21	Centered				E-2999			
		7	178	6	152	5/8	16	Centered					RD-1400 <sup>51</sup>		22-8020PK
		7	178	6	152	1	25	Centered				RD-1450			22-8021PK
		7	178	8	203	5/8	16	Centered					RD-1410		
		7	178	9	229	1	25	Centered				RD-1460			22-8022PK
		7	178	18	457	5/8	16	Centered					41-1400 <sup>2</sup>		25-3918
5	127	6-1/2	165	9	229	1	25	Centered				RU-3020			22-8022PK
		6-1/2	165	10	254	1	25	Centered				RU-3220			22-8022PK
5-1/2	140	7	178	9	229	1	25	Centered				RC-3150 <sup>2</sup>		22-8022PK	
6	152	7-1/2	191	4-1/2	114	1	25	Centered				RU-1850			
		7-1/2	191	6	152	1	25	Centered				RU-3060			25-3900
		7-1/2	191	8	203	1	25	Centered				RU-3260			
		7-1/2	191	10	254	1	25	Centered				RU-3270			RU-3270DR
		7-1/2	191	12	305	1	25	Centered				RU-3040			25-3918



1) 1/4-20 Jack Nut Into Top 2) Base Has (2) 7/8" Vents 3) Base Has 1/2" Vent 4) Base Has 1/32" Vent 5) Base Has 1/4" Vent 6) Base Has 11/16" Vent 7) Base Has 1-1/8" Vent 8) Base Has 13/16" Vent 9) Base Has 13/32" Vent 10) Base Has 3/64" Vent 11) Base Has 2-3/16" Square Inlet 12) Base Has 15/64" Vent 13) Base Has 19/32" Vent 14) Base Has 21/32" Vent 15) Base Has 25/64" Vent 16) Base Has 29/32" Vent 17) Base Has 3/16" Vent 18) Base Has 3/4" Vent 19) Base Has 3/8" Vent 20) Base Has 31/64" Vent 21) Base Has 35/64" Vent 22) Base Has 45/64" Vent 23) Base Has 5/16" Vent 24) Base Has 5/8" Vent 25) Base Has 55/64" Vent 26) Base Has 7/16" Vent 27) Base Has 7/8" Vent 28) Base Has 9/16" Vent 29) Base Has Opt. 1/2" Vent 30) Base Has 23/32" Vent 31) Base Has 25/32" Vent 32) Filter Has Molded-in Velocity Stack 33) Filter Is Reverse Tapered 34) Fits Legend/Dwarf Race Cars w/FJ1200 Motors 35) Base Has 15/32" Vent 36) Top Plate Has 1/4-20 Stud 37) Top-Plate Has 6MM Stud 39) Offset Is Vertical 41) Offset Is Vertical And To The Right 42) Top Has 1/2" Vent 43) Top Has 1-1/16" Center Hole 44) Top Has 21/32" Center Hole 45) Top Has 23/32" Center Hole 46) Top Has 5/32" Center Hole 47) Top Has 7/16" Center Hole 48) Base Has 11/32" Vent 49) Top Has 1/4" Center Hole 50) Top Has 1-7/16" Center Hole 51) 2-1/2" Adapter Included 52) Top Has 5/8" Vent 53) Tapered Insert Included 5" to 4-3/8" 54) Filter has Thru Hole 2-3/4" x 1-5/8"

# Round Tapered

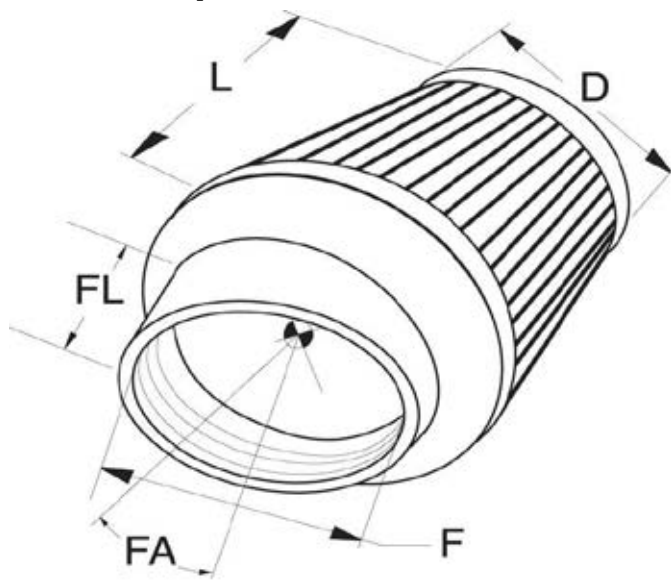

When selecting one of K&N's universal round tapered air filters, you should consider the following dimensions as they relate to the specification chart:

(F) Mounting Flange Inside Diameter - This is the most critical dimension and should be very close to the diameter of the application's inlet flange. The flange will stretch up to 1/16" for those in-between sizes.

(D) Filter Diameter - This is the outside diameter of the filter. Always use the largest diameter practical for maximum filtration.

(L) Filter Length - This dimension is the length of the filter body only, it does not include the flange length. Always use the longest filter practical for maximum filtration.

(FA/FL) Flange Angle and/or Length - If no angle is listed in the specifications table, then the flange is straight. Any angle listed is in degrees and can be utilized when space is a problem.

(FO) Flange Offset - In some cases the center of the flange is offset from the center of the filter base in order to provide a better fit.

(F) Mounting Flange Inside Diameter		(D) Filter Base Diameter		(D) Filter Top Diameter		(L) Filter Length		(FL) Flange Length		(FA) Flange Style		(FO) Flange Offset		Rubber End Cap Part #	Chrome End Cap Part #	Custom End Cap Part #	Filter Wraps Part #
Inch	mm	Inch	mm	Inch	mm	Inch	mm	Inch	mm	Type	Angle	Inch	mm				
5/16	8	1-3/8	35	1	25	1	25	5/8	16	Centered				RU-3490			
		1-3/8	35	1	25	1-3/8	35	3/8	10	Centered				RU-3170			
1	25	2-7/8	73	3-1/2	89	3-1/2	89	5/8	16	Centered				RE-0200 <sup>20</sup>			
1-1/8	29	2-1/4	57	2	51	2-1/2	64	5/8	16	Centered					RC-2540		RC-2540PK
1-1/4	32	2-7/8	73	3-1/2	89	3-1/2	89	5/8	16	Centered				RE-0220 <sup>20</sup>			
		2-15/16	75	3-1/2	89	2-7/16	62	5/8	16	Centered				RE-0230 <sup>20</sup>			
1-3/8	35	2-1/2	64	2	51	2-1/4	57	5/8	16	Centered					RC-0790		RC-0790PK
1-1/2	38	3	76	3-1/2	89	3-1/2	89	5/8	16	Centered				RE-0240 <sup>20</sup>			
1-9/16	40	2-5/8	67	2	51	3	76	5/8	16	Centered					RC-2290		
		3	76	2	51	3	76	5/8	16	Centered					RC-2310		22-8028PK
1-11/16	43	3	76	2	51	2-3/8	60	5/8	16	Centered					RC-2490		
		3	76	2	51	2-3/4	70	5/8	16	Centered				R-1070	RC-1070		22-8028PK
		3	76	2	51	4	102	1-1/2	38	Angled	40°			R-1100			22-8048PK
		3-1/2	89	2	51	4	102	5/8	16	Centered				R-1080			22-8029PK
1-3/4	44	2-15/16	75	3-1/2	89	3-1/2	89	5/8	16	Centered				RE-0260 <sup>20</sup>			
		3	76	2	51	2-1/2	64	5/8	16	Centered				RU-2690			
		4-3/8	111	3	76	2-1/2	64	5/8	16	Centered				RU-2680			
		4-1/2	114	3	76	2-1/2	64	5/8	16	Offset		9/16	14	RU-2740			
1-13/16	46	3	76	2	51	2-1/2	64	5/8	16	Centered				RU-2930			22-8028PK
		3	76	2	51	3	76	5/8	16	Centered				RU-2320	RC-2320		22-8028PK
1-7/8	48	3	76	2	51	2	51	5/8	16	Centered				RU-2550	RC-2550		
		3	76	2	51	3	76	5/8	16	Centered				R-1090	RC-1090		22-8028PK
		3	76	2	51	3-11/16	94	1	25	Angled	10°				RC-1290		22-8048PK
1-15/16	49	3	76	2	51	2-1/2	64	5/8	16	Centered				RU-2660	RC-2500		22-8028PK
		3	76	2	51	3	76	5/8	16	Centered				R-1060	RC-1060		22-8028PK
2	51	3	76	3-1/2	89	3-1/2	89	5/8	16	Centered				RE-0280 <sup>20</sup>			

1) 1/4-20 Jack Nut Into Top 2) Base Has (2) 7/8" Vents 3) Base Has 1/2" Vent 4) Base Has 1/32" Vent 5) Base Has 1/4" Vent 6) Base Has 11/16" Vent 7) Base Has 1-1/8" Vent 8) Base Has 13/16" Vent 9) Base Has 13/32" Vent 10) Base Has 13/64" Vent 11) Base Has 2-3/16" Square Inlet 12) Base Has 15/64" Vent 13) Base Has 19/32" Vent 14) Base Has 21/32" Vent 15) Base Has 25/64" Vent 16) Base Has 29/32" Vent 17) Base Has 3/16" Vent 18) Base Has 3/4" Vent 19) Base Has 3/8" Vent 20) Base Has 31/64" Vent 21) Base Has 35/64" Vent 22) Base Has 45/64" Vent 23) Base Has 5/16" Vent 24) Base Has 5/8" Vent 25) Base Has 55/64" Vent 26) Base Has 7/16" Vent 27) Base Has 7/8" Vent 28) Base Has 9/16" Vent 29) Base Has Opt. 1/2" Vent 30) Base Has 23/32" Vent 31) Base Has 25/32" Vent 32) Filter Has Molded-in Velocity Stack 33) Filter Is Reverse Tapered 34) Fits Legend/Dwarf Race Cars w/FJ1200 Motors 35) Base Has 15/32" Vent 36) Top Plate Has 1/4-20 Stud 37) Top-Plate Has 6MM Stud 39) Offset Is Vertical 41) Offset Is Vertical And To The Right 42) Top Has 1/2" Vent 43) Top Has 1-1/16" Center Hole 44) Top Has 21/32" Center Hole 45) Top Has 23/32" Center Hole 46) Top Has 5/32" Center Hole 47) Top Has 7/16" Center Hole 48) Base Has 11/32" Vent 49) Top Has 1/4" Center Hole 50) Top Has 1-7/16" Center Hole 51) 2-1/2" Adapter Included 52) Top Has 5/8" Vent 53) Tapered Insert Included 5" to 4-3/8" 54) Filter Has Thru Hole 2-3/4" x 1-5/8"



# Round Tapered

(F) Mounting Flange Inside Diameter		(D) Filter Base Diameter		(D) Filter Top Diameter		(L) Filter Length		(FL) Flange Length		(FA) Flange Style		(FO) Flange Offset		Rubber End Cap Part #	Chrome End Cap Part #	Custom End Cap Part #	Filter Wraps  Part #
Inch	mm	Inch	mm	Inch	mm	Inch	mm	Inch	mm	Type	Angle	Inch	mm				
2	51	3-1/8	79	2	51	3	76	5/8	16	Centered				RU-2580	RC-2580		22-8028PK
		5-3/16	132	3-1/2	89	3-7/16	87	1-3/8	35	Offset		21/32	17			RC-8350 <sup>37</sup>	
		5-3/16	132	3-1/2	89	3-11/16	94	1-3/8	35	Offset		21/32	17		RC-9920 <sup>34,19</sup>		
		6-7/8	175	5-7/8	149	2-9/16	65	1-3/4	44	Offset		7/8	22		RC-70018 <sup>3,19,5</sup>		
2-1/16	52	3-1/4	83	3	76	4	102	5/8	16	Centered					RC-1350		
		3-1/2	89	2	51	4	102	5/8	16	Centered				RU-1200	RC-1200		22-8029PK
		3-1/2	89	3	76	4	102	7/8	22	Centered					RA-050V		
2-1/32	52	3-5/8	92	3-1/2	89	4-7/8	124	7/16	11	Centered					RC-8170		
		6-27/32	174	5-7/8	149	2-9/16	65	1-25/32	45	Offset		27/32	21		RC-5154 <sup>42</sup>		
2-1/8	54	3	76	2	51	2-3/4	70	5/8	16	Centered					RC-2340		22-8028PK
		3	76	2	51	3	76	5/8	16	Centered					RC-2330		22-8028PK
		3-1/2	89	2	51	4	102	5/8	16	Centered					RC-1920		22-8029PK
		4-1/2	114	3-1/2	89	4-3/4	121	13/16	21	Centered					RC-4890		
		5-3/16	132	3-1/2	89	5-1/2	140	7/8	22	Offset		19/32	15		RC-8090 <sup>44</sup>		
2-1/4	57	3-1/2	89	2	51	4	102	5/8	16	Centered				R-1260	RC-1250		22-8029PK
		5	127	3-1/2	89	3-9/16	90	11/16	17	Centered					RC-9220 <sup>11</sup>		
		5-1/8	130	4-5/8	117	6	152	5/8	16	Centered				RU-3560			25-3900
2-9/32	58	4-17/32	115	3-1/2	89	4-15/16	125	2-13/32	61	Centered					RC-5157		
		6-27/32	174	5-13/16	148	2-9/16	65	1-25/32	45	Centered					RC-70021		
2-3/8	60	4-5/8	117	3-1/2	89	4-13/16	122	13/16	21	Centered					RC-9380		
		5-3/16	132	3-1/2	89	3-3/4	95	23/32	18	Offset		17/32	13		RC-1624		
		5-3/16	132	3-1/2	89	4-3/16	106	5/8	16	Offset		19/32	15		RC-9830 <sup>6</sup>		
		5-3/16	132	3-1/2	89	4-11/32	110	3/4	19	Offset		19/32	15		RC-8490 <sup>18</sup>		
		5-3/16	132	3-1/2	89	4-5/16	110	3/4	19	Offset		21/32	17		RC-9390		
2-13/32	61	4-23/32	120	3-31/32	101	3-3/4	95	3-11/32	85	Centered						RX-5179	
2-7/16	62	3-1/2	89	2	51	5	127	5/8	16	Centered				SN-2570			SN-2570PK
		3-3/4	95	3	76	4	102	2	51	Angled	20°			SN-2530			SN-2530PK
		3-3/4	95	3	76	5	127	2	51	Angled	20°			SN-2520			SN-2520PK
		3-3/4	95	3	76	6	152	2	51	Angled	20°			SN-2510			SN-2510PK
		4-1/2	114	4	102	4-1/32	102	23/32	18	Centered						RX-4010	
		4-1/2	114	4	102	6-1/8	156	7/8	22	Centered						RX-3820-1 <sup>1,15</sup>	RX-3820PK
		4-1/2	114	4	102	6-9/16	167	2-15/16	75	Angled	20°					RX-3800 <sup>15</sup>	RX-3820PK
		4-1/2	114	6	152	6-1/8	156	7/8	22	Centered						RX-3810XD <sup>1,15</sup>	RX-3810DK
		4-1/2	114	6	152	6-9/16	167	2-7/8	73	Angled	20°					RX-3770 <sup>1,15</sup>	RX-3810DK
		5-1/8	130	3-1/2	89	6	152	5/8	16	Centered					RC-4160		RC-4160DK
		5-1/2	140	4-1/2	114	4	102	5/8	16	Offset		1/2	13	R-1380			
2-1/2	64	4-1/2	114	3-1/2	89	3-3/16	81	3/4	19	Centered					RC-8100		
		4-1/2	114	3-1/2	89	5	127	3/4	19	Centered					RC-9630		RC-9350DK
		4-1/2	114	3-1/2	89	6	152	3/4	19	Centered					RC-5062XD		RC-5062DK
2-17/32	64	4-21/32	118	2-1/2	64	5-29/32	150	7/8	22	Centered					RC-9360		
2-1/2	64	4-21/32	118	3-1/2	89	3-7/8	98	13/16	21	Centered					RC-9080		
		4-21/32	118	3-1/2	89	4-7/8	124	13/16	21	Centered					RC-9800		
		5	127	5-1/2	140	2-3/4	70	5/8	16	Centered						RE-0380	
		5-1/8	130	3-7/16	87	3-3/4	95	3/4	19	Offset		19/32	15		RC-9700		
		5-3/16	132	3-1/2	89	4-17/32	115	3/4	19	Offset		19/32	15			RC-8320 <sup>37</sup>	

1) 1/4-20 Jack Nut Into Top 2) Base Has (2) 7/8" Vents 3) Base Has 1/2" Vent 4) Base Has 1/32" Vent 5) Base Has 1/4" Vent 6) Base Has 11/16" Vent 7) Base Has 1-1/8" Vent 8) Base Has 13/16" Vent 9) Base Has 13/32" Vent 10) Base Has 13/64" Vent 11) Base Has 2-3/16" Square Inlet 12) Base Has 15/64" Vent 13) Base Has 19/32" Vent 14) Base Has 21/32" Vent 15) Base Has 2-5/64" Vent 16) Base Has 29/32" Vent 17) Base Has 3/16" Vent 18) Base Has 3/4" Vent 19) Base Has 3/8" Vent 20) Base Has 31/64" Vent 21) Base Has 35/64" Vent 22) Base Has 45/64" Vent 23) Base Has 5/16" Vent 24) Base Has 5/8" Vent 25) Base Has 55/64" Vent 26) Base Has 7/16" Vent 27) Base Has 7/8" Vent 28) Base Has 9/16" Vent 29) Base Has Opt. 1/2" Vent 30) Base Has 23/32" Vent 31) Base Has 25/32" Vent 32) Filter Has Molded-in Velocity Stack 33) Filter Is Reverse Tapered 34) Fits Legend/Dwarf Race Cars w/FJ1200 Motors 35) Base Has 15/32" Vent 36) Top Plate Has 1/4-20 Stud 37) Top-Plate Has 6MM Stud 39) Offset Is Vertical 41) Offset Is Vertical And To The Right 42) Top Has 1/2" Vent 43) Top Has 1-1/16" Center Hole 44) Top Has 21/32" Center Hole 45) Top Has 23/32" Center Hole 46) Top Has 5/32" Center Hole 47) Top Has 7/16" Center Hole 48) Base Has 11/32" Vent 49) Top Has 1/4" Center Hole 50) Top Has 1-7/16" Center Hole 51) 2-1/2" Adapter Included 52) Top Has 5/8" Vent 53) Tapered Insert Included 5" to 4-3/8" 54) Filter has Thru Hole 2-3/4" x 1-5/8"

# Round Tapered

(F) Mounting Flange Inside Diameter		(D) Filter Base Diameter		(D) Filter Top Diameter		(L) Filter Length		(FL) Flange Length		(FA) Flange Style		(FO) Flange Offset		Rubber End Cap Part #	Chrome End Cap Part #	Custom End Cap Part #	Filter Wraps  Part #
Inch	mm	Inch	mm	Inch	mm	Inch	mm	Inch	mm	Type	Angle	Inch	mm				
2-1/2	64	5-3/16	132	3-1/2	89	4-9/16	116	3/4	19	Offset		11/16	17		RC-9780		
		5-3/16	132	3-1/2	89	4-11/16	119	3/4	19	Offset		19/32	15		RC-9690 <sup>21</sup>		
		5-3/16	132	3-1/2	89	5-5/32	131	5/8	16	Offset		19/32	15		RC-9490		
		5-3/16	132	3-1/2	89	5-15/16	151	3/4	19	Offset		19/32	15		RC-9510 <sup>21</sup>		
		5-1/4	133	2-1/2	64	5-3/4	146	1-1/2	38	Angled	20°			RU-5006			
		5-1/4	133	2-1/2	64	5-3/4	146	1-1/2	38	Centered				RU-5005			
		5-1/4	133	3-1/2	89	4-1/2	114	11/16	17	Offset		5/8	16		RC-9420 <sup>6</sup>		
		5-1/4	133	5-1/2	140	1-7/8	48	5/8	16	Centered						ML-0850	
		5-3/8	137	5-1/2	140	5-7/8	149	3/4	19	Centered				E-1006			
		5-1/2	140	4-1/2	114	6	152	3/4	19	Centered					RC-4670		RF-1023DK
		6	152	5	127	5	127	2	51	Centered				RU-5174			RX-4990DK
		6	152	5	127	5-1/2	140	2	51	Centered				RU-4950		RX-4950 <sup>1</sup>	RX-4990DK
		6	152	5	127	6-1/2	165	2	51	Centered				RU-4860		RX-4860 <sup>1</sup>	RX-4730DK
		6-11/16	170	3-1/2	89	7-3/32	180	7/8	22	Offset		1	25		RC-9300 <sup>31,35</sup>		
		6-27/32	174	5-27/32	148	2-9/16	65	1-25/32	45	Angled	30°				RC-5049		
2-9/16	65	6-7/8	175	5-7/8	149	2-1/2	64	1-11/16	43	Offset		7/8	22		RC-4620 <sup>4</sup>		
2-5/8	67	5-3/16	132	3-1/2	89	4-1/2	114	3/4	19	Offset		21/32	17		RC-9250		
		5-3/16	132	3-1/2	89	6	152	3/4	19	Offset		1-1/2	38		RC-9340		
2-11/16	68	4-7/16	113	3-1/2	89	4-7/16	113	5/8	16	Centered					RC-9280		
		4-1/2	114	3	76	5	127	5/8	16	Centered					RC-4340		SN-2520PK
		5-3/16	132	3-1/2	89	4-5/16	110	3/4	19	Offset		9/16	14		RC-8070 <sup>23</sup>		
		5-3/16	132	3-1/2	89	4-3/8	111	3/4	19	Offset		9/16	14		RC-9400 <sup>22,24</sup>		
		5-3/16	132	3-1/2	89	4-7/16	113	3/4	19	Offset		9/16	14		RC-9650		
		5-3/16	132	3-1/2	89	4-1/2	114	3/4	19	Offset		9/16	14		RC-9580 <sup>25</sup>		
		5-3/16	132	3-1/2	89	4-9/16	116	3/4	19	Offset		9/16	14		RC-9440 <sup>21</sup>		
		5-3/16	132	3-1/2	89	4-9/16	116	5/8	16	Offset		19/32	15		RC-9560		
		5-3/16	132	3-1/2	89	6	152	3/4	19	Offset		19/32	15		RC-9680 <sup>17</sup>		
		5-3/16	132	3-1/2	89	6	152	3/4	19	Offset		9/16	14		RC-9590 <sup>17</sup>		
		5-3/16	132	4	102	3-7/16	87	3/4	19	Offset		19/32	15	RU-9160			
		5-25/32	147	3-1/2	89	4-9/16	116	5/8	16	Offset		1/2	13		RC-9730 <sup>35,37</sup>		
2-23/32	69	6-11/16	170	3-1/2	89	7-23/32	196	5/8	16	Offset		1	25		RC-9290		
2-3/4	70	3-3/4	95	4	102	5-9/16	141	13/16	21	Centered				RU-5090			RC-9310DK
		4	102	2	51	6	152	1	25	Angled	10°			RU-3120			22-8030DK
		4	102	2	51	7	178	1	25	Angled	10°			RU-3590			
		4	102	3	76	5	127	1	25	Angled	10°			SN-2590			SN-2590PK
		4	102	3	76	6	152	1	25	Angled	10°			SN-2600			SN-2600PK
		4	102	3	76	6	152	2	51	Angled	20°			SN-2620			SN-2620PK
		4-1/2	114	3	76	4	102	5/8	16	Centered				SN-2580			SN-2580PK
		4-11/16	119	3-1/2	89	4-1/16	103	3/4	19	Centered					RC-9870		
		4-11/16	119	3-1/2	89	4-7/8	124	13/16	21	Centered					RC-9350		RC-9350DK
		4-11/16	119	3-1/2	89	4-15/16	125	13/16	21	Centered					RC-5133		
		4-11/16	119	3-1/2	89	5-5/16	135	13/16	21	Centered					RC-8340		
		4-11/16	119	3-1/2	89	6	152	3/4	19	Centered					RC-5159		
		4-3/4	121	3-1/2	89	5-7/8	149	13/16	21	Centered					RC-9310		RC-9310DK
		4-3/4	121	4	102	7-7/8	200	13/16	21	Centered					RC-5144		RC-4690DK

1) 1/4-20 Jack Nut Into Top 2) Base Has (2) 7/8" Vents 3) Base Has 1/2" Vent 4) Base Has 1/32" Vent 5) Base Has 1/4" Vent 6) Base Has 11/16" Vent 7) Base Has 1-1/8" Vent 8) Base Has 13/16" Vent 9) Base Has 13/32" Vent 10) Base Has 13/64" Vent 11) Base Has 2-3/16" Square Inlet 12) Base Has 15/64" Vent 13) Base Has 19/32" Vent 14) Base Has 21/32" Vent 15) Base Has 25/64" Vent 16) Base Has 29/32" Vent 17) Base Has 3/16" Vent 18) Base Has 3/4" Vent 19) Base Has 3/8" Vent 20) Base Has 31/64" Vent 21) Base Has 35/64" Vent 22) Base Has 45/64" Vent 23) Base Has 5/16" Vent 24) Base Has 5/8" Vent 25) Base Has 55/64" Vent 26) Base Has 7/16" Vent 27) Base Has 7/8" Vent 28) Base Has 9/16" Vent 29) Base Has Opt. 1/2" Vent 30) Base Has 23/32" Vent 31) Base Has 25/32" Vent 32) Filter Has Molded-in Velocity Stack 33) Filter Is Reverse Tapered 34) Fits Legend/Dwarf Race Cars w/FJ1200 Motors 35) Base Has 15/32" Vent 36) Top Plate Has 1/4-20 Stud 37) Top-Plate Has 6MM Stud 39) Offset Is Vertical 41) Offset Is Vertical And To The Right 42) Top Has 1/2" Vent 43) Top Has 1-1/16" Center Hole 44) Top Has 21/32" Center Hole 45) Top Has 23/32" Center Hole 46) Top Has 5/32" Center Hole 47) Top Has 7/16" Center Hole 48) Base Has 11/32" Vent 49) Top Has 1/4" Center Hole 50) Top Has 1-7/16" Center Hole 51) 2-1/2" Adapter Included 52) Top Has 5/8" Vent 53) Tapered Insert Included 5" to 4-3/8" 54) Filter has Thru Hole 2-3/4" x 1-5/8"

# Round Tapered

(F) Mounting Flange Inside Diameter		(D) Filter Base Diameter		(D) Filter Top Diameter		(L) Filter Length		(FL) Flange Length		(FA) Flange Style		(FO) Flange Offset		Rubber End Cap Part #	Chrome End Cap Part #	Custom End Cap Part #	Filter Wraps  Part #
Inch	mm	Inch	mm	Inch	mm	Inch	mm	Inch	mm	Type	Angle	Inch	mm				
2-3/4	70	5-1/16	129	3-1/2	89	3-3/16	81	3/4	19	Centered					RC-5127		
		5-1/16	129	3-1/2	89	4	102	3/4	19	Centered					RC-5128		
		5-1/16	129	3-1/2	89	4-3/8	111	3/4	19	Centered					RC-5135		
		5-1/16	129	3-1/2	89	5-1/2	140	3/4	19	Centered					RC-5131		
		5-3/16	132	3-1/2	89	4-11/32	110	3/4	19	Offset		19/32	15		RC-8410 <sup>17</sup>		
		5-3/16	132	3-1/2	89	4-5/16	110	3/4	19	Offset		1/2	13		RC-4490 <sup>6,23</sup>		
		5-3/16	132	3-1/2	89	4-3/8	111	3/4	19	Offset		17/32	13		RC-9980 <sup>21,22</sup>		
		5-3/16	132	3-1/2	89	4-31/32	126	5/8	16	Offset		19/32	15		RC-8470 <sup>38,40</sup>		
		5-3/16	132	3-1/2	89	5-1/8	130	3/4	19	Offset		11/16	17		RC-4500 <sup>2</sup>		25-3900
		5-1/2	140	4-1/2	114	7	178	2-1/2	64	Angled	30°				RC-4790		25-3900
		5-3/4	146	3-1/2	89	6-11/16	170	3/4	19	Offset		1-1/2	38		RC-1586		
		5-3/4	146	5-15/16	151	7-11/16	195	7/16	11	Centered						RR-3004	
		5-25/32	147	3-1/2	89	4-17/32	115	3/4	19	Offset		1/2	13		RC-9940 <sup>27,30</sup>		
		5-7/8	149	4-1/2	114	5	127	3/4	19	Centered					RC-5284		
		5-7/8	149	4-3/4	121	2-5/8	67	3/4	19	Centered				RU-3390			
		5-7/8	149	4-3/4	121	5	127	3/4	19	Centered				RU-4450			25-3900
		5-7/8	149	4-3/4	121	7	178	3/4	19	Centered				RU-3610			25-3900
		5-7/8	149	5-1/4	133	5	127	3/4	19	Centered						RR-2803	
		6	152	5	127	5-1/2	140	2	51	Centered				RU-4960XD			RX-4960 <sup>1</sup> RX-4990DK
		6	152	5	127	6-1/2	165	2	51	Centered				RU-4870			RX-4870 RX-4730DK
		6-3/4	171	5-7/8	149	3-1/4	83	3/4	19	Centered					RC-4850 <sup>1</sup>	E-2232	
		6-7/8	175	5-7/8	149	2-5/8	67	3/4	19	Centered					RC-9880		
2-13/16	71	4-7/16	113	3-1/2	89	5	127	3-9/16	90	Centered					RC-4510 <sup>6</sup>		25-3900
		6-7/8	175	5-7/8	149	3-1/8	79	3/4	19	Offset		3/4	19		RC-4640 <sup>4</sup>		
2-27/32	72	5-3/16	132	3-3/4	95	3-3/4	95	3/4	19	Offset		9/16	14	RU-5146			
2-7/8	73	4	102	3	76	5	127	5/8	16	Centered					RC-2600		25-3900
		4-1/4	108	4	102	4-3/4	121	15/16	24	Centered						RX-4020-1 <sup>1</sup>	
		4-1/2	114	3-1/2	89	5-7/8	149	3/4	19	Centered					RC-5136		25-3900
		5-3/16	132	3-1/2	89	4-7/16	113	3/4	19	Offset		15/32	12		RC-4570 <sup>6</sup>		
		5-3/16	132	3-1/2	89	4-1/2	114	2-7/8	73	Offset		1/2	13		RC-8390		
2-29/32	74	4-21/32	118	2-5/16	59	5-29/32	150	23/32	18	Centered				RU-9220			25-3900
2-15/16	75	6-3/4	171	5-7/8	149	3-1/8	79	3/4	19	Offset		13/16	21		RC-4770 <sup>4</sup>		
3	76	4-1/2	114	3-1/2	89	4-5/16	110	3/4	19	Centered					RC-9410		
		4-1/2	114	3-1/2	89	5-3/4	146	3/4	19	Centered				RU-5111			25-3900
		4-1/2	114	6	152	4-5/8	117	7/8	22	Centered						RX-3900-1 <sup>1</sup>	
		5	127	3-1/2	89	4-5/8	117	3/4	19	Centered					RC-9480		
		5	127	3-1/2	89	5-15/16	151	3/4	19	Centered					RC-9640		
		5	127	3-1/2	89	6	152	1-3/4	44	Centered					RF-1039		RC-4160DK
		5	127	4	102	6	152	1-3/4	44	Centered					RC-4650		RC-4650DK
		5	127	4	102	7-7/8	200	1-1/4	32	Centered					RC-4690		RC-4690DK
		5	127	4-1/2	114	5	127	1-3/4	44	Centered					RC-3870		25-3900
		5	127	4-1/2	114	6-1/2	165	1-13/16	46	Centered					RF-1030		RC-4630DK
		5	127	4-5/8	117	4	102	1-3/4	44	Centered				RU-3700			22-8014PK
		5	127	4-5/8	117	8	203	1-3/4	44	Centered				RE-0910			RE-0910PK
		6	152	3-1/2	89	6	152	1-3/4	44	Centered					RC-4290		

1) 1/4-20 Jack Nut Into Top 2) Base Has (2) 7/8" Vents 3) Base Has 1/2" Vent 4) Base Has 1/32" Vent 5) Base Has 1/4" Vent 6) Base Has 11/16" Vent 7) Base Has 1-1/8" Vent 8) Base Has 13/16" Vent 9) Base Has 13/32" Vent 10) Base Has 13/64" Vent 11) Base Has 2-3/16" Square Inlet 12) Base Has 15/64" Vent 13) Base Has 19/32" Vent 14) Base Has 21/32" Vent 15) Base Has 25/64" Vent 16) Base Has 29/32" Vent 17) Base Has 3/16" Vent 18) Base Has 3/4" Vent 19) Base Has 3/8" Vent 20) Base Has 31/64" Vent 21) Base Has 35/64" Vent 22) Base Has 45/64" Vent 23) Base Has 5/16" Vent 24) Base Has 5/8" Vent 25) Base Has 55/64" Vent 26) Base Has 7/16" Vent 27) Base Has 7/8" Vent 28) Base Has 9/16" Vent 29) Base Has Opt. 1/2" Vent 30) Base Has 23/32" Vent 31) Base Has 25/32" Vent 32) Filter Has Molded-in Velocity Stack 33) Filter Is Reverse Tapered 34) Fits Legend/Dwarf Race Cars w/FJ1200 Motors 35) Base Has 15/32" Vent 36) Top Plate Has 1/4-20 Stud 37) Top-Plate Has 6MM Stud 39) Offset Is Vertical 41) Offset Is Vertical And To The Right 42) Top Has 1/2" Vent 43) Top Has 1-1/16" Center Hole 44) Top Has 21/32" Center Hole 45) Top Has 23/32" Center Hole 46) Top Has 5/32" Center Hole 47) Top Has 7/16" Center Hole 48) Base Has 11/32" Vent 49) Top Has 1/4" Center Hole 50) Top Has 1-7/16" Center Hole 51) 2-1/2" Adapter Included 52) Top Has 5/8" Vent 53) Tapered Insert Included 5" to 4-3/8" 54) Filter has Thru Hole 2-3/4" x 1-5/8"

# Round Tapered

(F) Mounting Flange Inside Diameter		(D) Filter Base Diameter		(D) Filter Top Diameter		(L) Filter Length		(FL) Flange Length		(FA) Flange Style		(FO) Flange Offset		Rubber End Cap Part #	Chrome End Cap Part #	Custom End Cap Part #	Filter Wraps Part #
Inch	mm	Inch	mm	Inch	mm	Inch	mm	Inch	mm	Type	Angle	Inch	mm				
3	76	6	152	4	102	5	127	1-3/4	44	Centered				RU-3580			25-3900
		6	152	4	102	6-3/4	171	1-3/4	44	Centered					RC-4700		RC-4700DK
		6	152	4	102	8-11/16	221	15/16	24	Centered						RX-3990-1 <sup>1</sup>	
		6	152	4-1/2	114	6	152	1-3/4	44	Centered					RC-4180		22-8033PK
		6	152	4-1/2	114	8	203	1-3/4	44	Centered					RC-5106		RC-5106DK
		6	152	4-5/8	117	6	152	1-3/4	44	Centered			RE-0930				22-8033PK
		6	152	4-5/8	117	9	229	1-3/4	44	Centered			RE-0810				25-0810
		6	152	4-5/8	117	12	305	1-3/4	44	Centered			RE-0800				22-8034PK
		6	152	4-5/8	117	14	356	1-3/4	44	Centered			RE-0820				22-8035PK
		6	152	4-3/4	121	6	152	1-3/4	44	Centered			RE-0930-L				
		6	152	5	127	5	127	1-3/4	44	Centered			RU-5176				RX-4990DK
		6	152	5	127	5-9/16	141	1-3/4	44	Centered			RU-4990			RX-4990 <sup>1</sup>	RX-4990DK
		6	152	5	127	6	152	1-3/4	44	Centered						RF-1047	25-3900
		6	152	5	127	6-1/2	165	1-3/4	44	Centered			RU-4730			RX-4730XD <sup>1</sup>	RX-4730DK
		6	152	5-1/8	130	5	127	1-3/4	44	Centered			RU-3570				RX-4990DK
		6	152	5-1/4	133	5	127	1-3/4	44	Centered						RR-3003	
		6	152	5-7/8	149	6	152	1-3/4	44	Centered						RD-1100	
3-1/8	79	4-7/8	124	3-1/2	89	5-7/16	138	23/32	18	Centered							RC-9240
		4-15/16	125	3-1/2	89	3-15/16	100	3/4	19	Centered							RC-9270
		4-15/16	125	3-1/2	89	4-3/8	111	15/16	24	Centered							RC-9610
		4-15/16	125	3-1/2	89	4-5/8	117	3/4	19	Centered							RC-8220
		4-15/16	125	3-1/2	89	6	152	15/16	24	Centered							RC-8250
		5	127	3-1/2	89	6	152	3/4	19	Centered							RC-9320
		6	152	4-5/8	117	14	356	1-3/4	44	Centered			RE-0940				RC-4160DK
		6	152	5	127	7	178	1-3/4	44	Centered							RC-5100
																	RC-5100DK
3-5/32	80	5-3/4	146	3-1/2	89	4-7/16	113	3/4	19	Offset		1/2	13				RC-9110 <sup>4</sup>
		5-25/32	147	3-1/2	89	4-17/32	115	25/32	20	Offset		15/32	12				RC-9670 <sup>16</sup>
		5-25/32	147	3-1/2	89	4-17/32	115	3/4	19	Offset		1/2	13				RC-9910
		5-25/32	147	3-1/2	89	5-15/32	139	3/4	19	Offset		1/2	13				RC-8370 <sup>40</sup>
		5-25/32	147	3-1/2	89	7-23/32	196	5/8	16	Centered							RC-9950 <sup>38,19,14</sup>
		6-15/16	176	3-1/2	89	7-27/32	199	3/4	19	Offset		13/32	10				RC-8450
3-1/4	83	5-1/2	140	4-1/2	114	8	203	5/8	16	Centered							RF-1025 <sup>19</sup>
		5-1/2	140	4-11/16	119	8	203	1-5/8	41	Centered				RU-5122			RC-5106DK
		5-3/4	146	3-1/2	89	4-25/32	121	3/4	19	Offset		9/16	14				RC-9660 <sup>4</sup>
		5-3/4	146	3-1/2	89	5-1/2	140	23/32	18	Offset		5/8	16				RC-1637
		5-3/4	146	3-1/2	89	6-5/8	168	3/4	19	Offset		1/2	13				RC-4560 <sup>2</sup>
		5-3/4	146	3-1/2	89	6-11/16	170	3/4	19	Offset		1/2	13				RC-4470
3-5/16	84	4	102	3-5/16	84	5-13/16	148	1/2	13	Centered							YA-4003
		4-3/4	121	3-1/2	89	4-3/8	111	3/4	19	Centered							RC-9770
		4-3/4	121	3-1/2	89	6	152	3/4	19	Centered							RC-4540
		4-3/4	121	3-1/2	89	6-1/2	165	5/8	16	Centered				RU-2710	RC-2710		25-3900
		4-7/8	124	4	102	4-1/4	108	15/16	24	Centered							RX-4120-1 <sup>1</sup>
		5-13/16	148	3-1/2	89	6-9/32	160	7/8	22	Offset		1/2	13				RC-8110 <sup>42</sup>
3-3/8	86	4-15/16	125	3-1/2	89	3-7/8	98	15/16	24	Centered							RC-9790
		5-3/4	146	3-1/2	89	4-1/4	108	3/4	19	Offset		9/16	14				RC-8200 <sup>3,4</sup>

1) 1/4-20 Jack Nut Into Top 2) Base Has (2) 7/8" Vents 3) Base Has 1/2" Vent 4) Base Has 1/32" Vent 5) Base Has 1/4" Vent 6) Base Has 11/16" Vent 7) Base Has 1-1/8" Vent 8) Base Has 13/16" Vent 9) Base Has 13/32" Vent 10) Base Has 13/64" Vent 11) Base Has 2-3/16" Square Inlet 12) Base Has 15/64" Vent 13) Base Has 19/32" Vent 14) Base Has 21/32" Vent 15) Base Has 25/64" Vent 16) Base Has 29/32" Vent 17) Base Has 3/16" Vent 18) Base Has 3/4" Vent 19) Base Has 3/8" Vent 20) Base Has 31/64" Vent 21) Base Has 35/64" Vent 22) Base Has 45/64" Vent 23) Base Has 5/16" Vent 24) Base Has 5/8" Vent 25) Base Has 55/64" Vent 26) Base Has 7/16" Vent 27) Base Has 7/8" Vent 28) Base Has 9/16" Vent 29) Base Has Opt. 1/2" Vent 30) Base Has 23/32" Vent 31) Base Has 25/32" Vent 32) Filter Has Molded-In Velocity Stack 33) Filter Is Reverse Tapered 34) Fits Legend/Dwarf Race Cars w/FJ1200 Motors 35) Base Has 15/32" Vent 36) Top Plate Has 1/4-20 Stud 37) Top-Plate Has 6MM Stud 39) Offset Is Vertical 41) Offset Is Vertical And To The Right 42) Top Has 1/2" Vent 43) Top Has 1-1/16" Center Hole 44) Top Has 21/32" Center Hole 45) Top Has 23/32" Center Hole 46) Top Has 5/32" Center Hole 47) Top Has 7/16" Center Hole 48) Base Has 11/32" Vent 49) Top Has 1/4" Center Hole 50) Top Has 1-7/16" Center Hole 51) 2-1/2" Adapter Included 52) Top Has 5/8" Vent 53) Tapered Insert Included 5" to 4-3/8" 54) Filter Has Thru Hole 2-3/4" x 1-5/8"

# Round Tapered

(F) Mounting Flange Inside Diameter		(D) Filter Base Diameter		(D) Filter Top Diameter		(L) Filter Length		(FL) Flange Length		(FA) Flange Style		(FO) Flange Offset		Rubber End Cap Part #	Chrome End Cap Part #	Custom End Cap Part #	Filter Wraps Part #		
Inch	mm	Inch	mm	Inch	mm	Inch	mm	Inch	mm	Type	Angle	Inch	mm						
3-3/8	86	5-3/4	146	3-1/2	89	4-7/16	113	3/4	19	Offset		9/16	14		RC-9970 <sup>4</sup>				
		5-3/4	146	3-1/2	89	4-7/8	124	3/4	19	Offset		9/16	14		RC-8000 <sup>18</sup>				
		5-3/4	146	3-1/2	89	5-7/16	138	3/4	19	Offset		5/8	16		RC-9120 <sup>35</sup>				
		5-3/4	146	3-1/2	89	6-15/16	176	3/4	19	Offset		9/16	14		RC-8150				
		5-13/16	148	4	102	6	152	5/8	16	Centered				RU-5168			RU-5168DK		
		6	152	4-1/2	114	9	229	3/4	19	Centered						RP-5118	RC-3690DK		
3-13/32	87	5-13/16	148	3-1/2	89	7-27/32	199	3/4	19	Offset		1	25		RC-8260 <sup>38</sup>				
3-1/2	89	4-5/8	117	3-1/2	89	3	76	5/8	16	Centered				RU-4410					
		4-5/8	117	3-1/2	89	4-1/2	114	5/8	16	Centered					RU-2790				
		4-5/8	117	3-1/2	89	5-1/2	140	5/8	16	Centered					RU-3550			25-3900	
		4-5/8	117	3-1/2	89	7	178	5/8	16	Centered					RU-3130-L			RU-3130DK	
		5	127	3-1/2	89	4	102	5/8	16	Centered					RU-2990				
		5	127	5-1/8	130	2	51	5/8	16	Centered						RC-4230 <sup>16</sup>			
		5-1/2	140	4	102	8	203	1-1/4	32	Centered						RF-1045		RF-1045DK	
		5-1/2	140	4-1/2	114	6-1/2	165	1-1/4	32	Centered						RC-4630XD	RP-4630	RC-4630DK	
		5-1/2	140	4-1/2	114	8	203	1-1/4	32	Centered						RC-4760		RC-5106DK	
		5-3/4	146	3-1/2	89	6	152	1-3/4	44	Angled	10°					RF-1035		RF-1035DK	
		5-3/4	146	3-3/4	95	6	152	1-3/4	44	Angled	10°					RF-1031		RU-5168DK	
		5-3/4	146	4-1/2	114	6	152	1-3/4	44	Angled	10°					RF-1023		22-8033PK	
		5-3/4	146	5	127	7	178	1-3/4	44	Angled	10°					RF-1016 <sup>2</sup>		25-3900	
		5-3/4	146	5	127	8	203	1-3/4	44	Angled	10°					RF-1003 <sup>2</sup>			
		5-3/4	146	5	127	12-1/8	308	1-3/4	44	Angled	10°					RF-1004 <sup>2</sup>			
		6	152	4-1/2	114	9	229	1-3/4	44	Centered						RC-3690		RC-3690DK	
		6	152	4-5/8	117	6	152	1-3/4	44	Centered						RE-0950		22-8033PK	
		6	152	4-5/8	117	9	229	1-3/4	44	Centered						RE-0920		RE-0810PK	
		8	203	6-5/8	168	8	203	1-1/2	38	Centered						RC-5112		RC-5112DK	
8	203	7	178	12-1/2	318	1-1/2	38	Centered						RC-5165		RC-5165DK			
3-5/8	92	4	102	3-3/4	95	6	152	5/8	16	Centered				RD-6010					
3-3/4	95	5-3/8	137	4-3/8	111	5	127	5/8	16	Centered				RU-4250			25-3900		
		5-3/8	137	4-3/8	111	7	178	5/8	16	Centered				RU-3530			RU-2590DK		
		5-3/4	146	3-1/2	89	6-3/4	171	3/4	19	Offset		7/16	11		RC-8480		25-3900		
3-13/16	97	6-13/16	173	6	152	2-1/8	54	3/4	19	Centered						RX-4130-1 <sup>1</sup>			
3-7/8	98	4-1/4	108	3-1/2	89	4-1/4	108	7/16	11	Centered				RD-6020					
		4-1/4	108	4	102	6	152	7/16	11	Centered				RD-6000			22-8031PK		
		6-3/4	171	5-7/8	149	2-3/4	70	3/4	19	Offset		3/8	10		RC-4840 <sup>4</sup>				
3-27/32	98	6-7/8	175	5-7/8	149	2-25/32	71	3/4	19	Offset		7/16	11		RC-9600				
		6-7/8	175	5-7/8	149	3-3/16	81	3/4	19	Offset		13/32	10		RC-9990 <sup>24</sup>				
		6-15/16	176	3-1/2	89	2-11/16	68	3/4	19	Centered					RC-9520				
3-7/8	98	6-15/16	176	3-1/2	89	7-23/32	196	5/8	16	Offset		3/8	10		RC-9540				
3-27/32	98	6-15/16	176	5-13/16	148	3-5/32	80	3/4	19	Offset		197/500	10		RC-9860 <sup>14</sup>				
3-7/8	98	7-1/2	191	5-1/8	130	7	178	1-1/2	38	Centered				RF-1029 <sup>19</sup>		RF-1029DK			
3-15/16	100	5-7/16	138	4-1/2	114	3-5/8	92	3/4	19	Centered					RC-5057				
		5-7/16	138	4-1/2	114	6	152	3/4	19	Centered						RF-1633 <sup>47</sup>			
		5-1/2	140	4-1/2	114	3-1/4	83	3/4	19	Centered						RC-5153			
		5-1/2	140	4-1/2	114	4-1/2	114	3/4	19	Centered						RC-5059			

1) 1/4-20 Jack Nut Into Top 2) Base Has (2) 7/8" Vents 3) Base Has 1/2" Vent 4) Base Has 1/32" Vent 5) Base Has 1/4" Vent 6) Base Has 11/16" Vent 7) Base Has 1-1/8" Vent 8) Base Has 13/16" Vent 9) Base Has 13/32" Vent 10) Base Has 13/64" Vent 11) Base Has 2-3/16" Square Inlet 12) Base Has 15/64" Vent 13) Base Has 19/32" Vent 14) Base Has 21/32" Vent 15) Base Has 25/64" Vent 16) Base Has 29/32" Vent 17) Base Has 3/16" Vent 18) Base Has 3/4" Vent 19) Base Has 3/8" Vent 20) Base Has 31/64" Vent 21) Base Has 35/64" Vent 22) Base Has 45/64" Vent 23) Base Has 5/16" Vent 24) Base Has 5/8" Vent 25) Base Has 55/64" Vent 26) Base Has 7/16" Vent 27) Base Has 7/8" Vent 28) Base Has 9/16" Vent 29) Base Has Opt. 1/2" Vent 30) Base Has 23/32" Vent 31) Base Has 25/32" Vent 32) Filter Has Molded-in Velocity Stack 33) Filter Is Reverse Tapered 34) Fits Legend/Dwarf Race Cars w/FJ1200 Motors 35) Base Has 15/32" Vent 36) Top Plate Has 1/4-20 Stud 37) Top Plate Has 6MM Stud 38) Offset Is Vertical 41) Offset Is Vertical And To The Right 42) Top Has 1/2" Vent 43) Top Has 1-1/16" Center Hole 44) Top Has 21/32" Center Hole 45) Top Has 23/32" Center Hole 46) Top Has 5/32" Center Hole 47) Top Has 7/16" Center Hole 48) Base Has 11/32" Vent 49) Top Has 1/4" Center Hole 50) Top Has 1-7/16" Center Hole 51) 2-1/2" Adapter Included 52) Top Has 5/8" Vent 53) Tapered Insert Included 5" to 4-3/8" 54) Filter Has Thru Hole 2-3/4" x 1-5/8"

# Round Tapered

(F) Mounting Flange Inside Diameter		(D) Filter Base Diameter		(D) Filter Top Diameter		(L) Filter Length		(FL) Flange Length		(FA) Flange Style		(FO) Flange Offset		Rubber End Cap Part #	Chrome End Cap Part #	Custom End Cap Part #	Filter Wraps Part #	
Inch	mm	Inch	mm	Inch	mm	Inch	mm	Inch	mm	Type	Angle	Inch	mm					
3-15/16	100	5-1/2	140	4-1/2	114	5	127	3/4	19	Centered					RC-5156			
		5-1/2	140	4-1/2	114	5-15/16	151	3/4	19	Centered					RC-5053			
		5-1/2	140	4-1/2	114	6	152	3/4	19	Centered						RF-1682		
4	102	5-3/8	137	3-1/2	89	6	152	5/8	16	Centered				RU-5141 <sup>35</sup>			RP-4660DK	
		5-3/8	137	4	102	5-1/16	129	5/8	16	Centered						RP-4930	RP-4660DK	
		5-3/8	137	4	102	5-1/2	140	5/8	16	Centered						RP-4660	RP-4660DK	
		5-3/8	137	4	102	6-1/2	165	5/8	16	Centered					RC-5149	RP-4980	RC-5149DK	
		5-3/8	137	4	102	7	178	5/8	16	Centered						RP-4970	22-8032PK	
		5-3/8	137	4-3/8	111	3-1/2	89	5/8	16	Centered				RU-2510				
		5-3/8	137	4-3/8	111	5	127	5/8	16	Centered				RU-2520			25-3900	
		5-3/8	137	4-3/8	111	7	178	5/8	16	Centered				RU-2590			RU-2590DK	
		5-3/8	137	4-1/2	114	5	127	5/8	16	Centered					RC-3600		25-3900	
		5-3/8	137	4-1/2	114	6	152	5/8	16	Centered					RF-1049 <sup>3</sup>		RF-1023DK	
		5-3/8	137	4-1/2	114	7-1/2	191	5/8	16	Centered					RF-1007 <sup>2</sup>			
		5-3/8	137	4-1/2	114	8	203	5/8	16	Centered					RC-4580			
		5-3/8	137	5	127	6-1/2	165	5/8	16	Centered					RF-1018 <sup>42</sup>		25-3900	
		5-1/2	140	7	178	6	152	3/4	19	Centered					RD-1200 <sup>51</sup>			
		6	152	4	102	7	178	1-3/4	44	Centered						RC-4680		RF-1032DK
		6	152	4	102	8	203	1-3/4	44	Centered						RF-1046		
		6	152	4-1/2	114	7	178	5/8	16	Centered					RF-1015			RF-1015DK
		6	152	4-5/8	117	9	229	1-3/4	44	Centered					RE-0870-L			25-0810
		6	152	4-5/8	117	12	305	1-3/4	44	Centered					RE-0860			22-8034PK
		6	152	4-5/8	117	14	356	1-3/4	44	Centered					RE-0880			22-8035PK
6	152	4-3/4	121	5-1/2	140	1-1/8	29	Centered						RG-1001WT-L				
6	152	4-3/4	121	8-5/8	219	1	25	Centered						E-1997				
6	152	4-3/4	121	9-1/2	241	1-1/8	29	Centered						RG-1002RD-L				
6-1/2	165	4-1/2	114	6	152	1-3/4	44	Centered						RC-5060		RC-5060DK		
6-1/2	165	4-1/2	114	7	178	1-3/4	44	Centered						RF-1032		RF-1032DK		
6-1/2	165	4-1/2	114	8	203	1-3/4	44	Centered						RF-1027		RF-1027DK		
6-5/8	168	5-1/4	133	9-1/2	241	1-11/16	43	Centered							RC-4780 <sup>2,29,30</sup>	RC-4780DK		
6-3/4	171	5-7/8	149	9-1/2	241	1-3/4	44	Centered					RU-5045			RU-5045DK		
6-7/8	175	5-7/8	149	2-3/4	70	3/4	19	Offset	1/2	13				RC-9500 <sup>19</sup>				
8	203	6-5/8	168	8	203	1-1/2	38	Centered						RU-5171HBK			25-5166	
8	203	6-5/8	168	12	305	1-1/2	38	Centered							RC-5171	25-5166		
4-1/16	103	6-7/8	175	5-7/8	149	2-3/16	56	3/4	19	Offset		15/32	12		RC-4480 <sup>4</sup>			
		6-15/16	176	5-27/32	148	3-5/32	80	3/4	19	Offset		3/8	10		RC-9470 <sup>45</sup>			
4-1/8	105	7-3/8	187	6-5/8	168	7-7/8	200	1-1/8	29	Centered					RC-4900 <sup>29</sup>	RC-4900DK		
		7-3/8	187	7	178	11-1/2	292	1-1/8	29	Centered					RC-5181	RF-1026DK		
4-1/4	108	5-1/2	140	5-11/32	136	6	152	843/1000	21	Centered					RC-1645			
		5-7/8	149	4-1/2	114	6-3/4	171	5/8	16	Centered						RP-5167	RF-1037DK	
4-5/16	110	5-1/2	140	3-1/2	89	3-3/8	86	5/8	16	Centered					RC-9460			
		5-1/2	140	3-1/2	89	4-3/8	111	5/8	16	Centered					RC-9890			
4-3/8	111	5-1/2	140	3-1/2	89	5-3/16	132	15/16	24	Centered					RC-9210			
		6	152	4-5/8	117	6-1/2	165	1-1/4	32	Angled	10°			RU-5061			RX-4990DK	
4-1/2	114	5-7/8	149	4	102	6	152	5/8	16	Centered					RP-5101	RU-5168DK		

1) 1/4-20 Jack Nut Into Top 2) Base Has (2) 7/8" Vents 3) Base Has 1/2" Vent 4) Base Has 1/32" Vent 5) Base Has 1/4" Vent 6) Base Has 11/16" Vent 7) Base Has 1-1/8" Vent 8) Base Has 13/16" Vent 9) Base Has 13/32" Vent 10) Base Has 13/64" Vent 11) Base Has 2-3/16" Square Inlet 12) Base Has 15/64" Vent 13) Base Has 19/32" Vent 14) Base Has 21/32" Vent 15) Base Has 25/64" Vent 16) Base Has 29/32" Vent 17) Base Has 3/16" Vent 18) Base Has 3/4" Vent 19) Base Has 3/8" Vent 20) Base Has 31/64" Vent 21) Base Has 35/64" Vent 22) Base Has 45/64" Vent 23) Base Has 5/16" Vent 24) Base Has 5/8" Vent 25) Base Has 55/64" Vent 26) Base Has 7/16" Vent 27) Base Has 7/8" Vent 28) Base Has 9/16" Vent 29) Base Has Opt. 1/2" Vent 30) Base Has 23/32" Vent 31) Base Has 25/32" Vent 32) Filter Has Molded-in Velocity Stack 33) Filter Is Reverse Tapered 34) Fits Legend/Dwarf Race Cars w/FJ1200 Motors 35) Base Has 15/32" Vent 36) Top Plate Has 1/4-20 Stud 37) Top Plate Has 6MM Stud 38) Offset Is Vertical 39) Offset Is Vertical And To The Right 40) Top Has 1/2" Vent 41) Top Has 1-1/16" Center Hole 42) Top Has 21/32" Center Hole 43) Top Has 23/32" Center Hole 44) Top Has 5/32" Center Hole 45) Top Has 5/16" Center Hole 46) Top Has 7/16" Center Hole 47) Base Has 11/32" Vent 48) Base Has 1/4" Center Hole 49) Top Has 1-7/16" Center Hole 50) Top Has 1-7/16" Center Hole 51) 2-1/2" Adapter Included 52) Top Has 5/8" Vent 53) Tapered Insert Included 5" to 4-3/8" 54) Filter Has Thru Hole 2-3/4" x 1-5/8"

# Round Tapered

(F) Mounting Flange Inside Diameter		(D) Filter Base Diameter		(D) Filter Top Diameter		(L) Filter Length		(FL) Flange Length		(FA) Flange Style		(FO) Flange Offset		Rubber End Cap Part #	Chrome End Cap Part #	Custom End Cap Part #	Filter Wraps Part #
Inch	mm	Inch	mm	Inch	mm	Inch	mm	Inch	mm	Type	Angle	Inch	mm				
4-1/2	114	5-7/8	149	4-1/2	114	4-1/2	114	5/8	16	Centered					RF-1005		
		5-7/8	149	4-1/2	114	5	127	5/8	16	Centered						RT-4610	25-3900
		5-7/8	149	4-1/2	114	6	152	5/8	16	Centered				RU-4740		RP-4740	RF-1023DK
		5-7/8	149	4-1/2	114	8-3/8	213	5/8	16	Centered					RF-1008		RC-5106DK
		5-7/8	149	5	127	3-1/4	83	5/8	16	Centered				RU-3110			
		5-7/8	149	5	127	6	152	5/8	16	Centered				RU-3480			RU-3480PK
		5-7/8	149	5-1/8	130	5	127	5/8	16	Centered				RU-4260			25-3900
		8	203	6-5/8	168	8	203	1-1/2	38	Centered				RU-5283HBK			RC-5112DK
		8	203	6-5/8	168	8	203	1-3/8	35	Centered						RC-5283 <sup>29</sup>	RC-5112DK
		8	203	6-5/8	168	12	305	1-3/8	35	Centered						RC-5166	25-5166
4-7/8	124	9	229	6-5/8	168	7-15/16	202	1-1/4	32	Centered				RU-5172			RC-5139DK
5	127	6-1/2	165	4-3/8	111	7	178	1	25	Centered				RU-2800			25-3900
		6-1/2	165	4-1/2	114	4-1/8	105	1	25	Centered				RU-5163			RU-5163DK
		6-1/2	165	4-1/2	114	5-1/2	140	1	25	Centered				RU-5147			RU-5147DK
		6-1/2	165	4-1/2	114	5-5/8	143	1	25	Centered						RP-5113	RU-5147DK
		6-1/2	165	5	127	6-1/2	165	1	25	Centered					RF-1037		RF-1037DK
		6-1/2	165	6-3/4	171	5	127	1	25	Centered				RU-5109			25-3900
5-5/8	143	7-1/2	191	5-3/4	146	8	203	1-1/8	29	Centered				E-1993			
6	152	7-1/2	191	4-1/2	114	4	102	1	25	Centered				RU-4600		RT-4600	22-8036PK
		7-1/2	191	4-1/2	114	5	127	1	25	Centered						RT-4590	22-8049DK
		7-1/2	191	4-1/2	114	5	127	5/8	16	Centered						RC-5138	22-8049DK
		7-1/2	191	4-1/2	114	6	152	5/8	16	Centered						RF-1048	RF-1048DK
		7-1/2	191	4-1/2	114	6-1/2	165	5/8	16	Centered						RC-5107	RC-5107DK
		7-1/2	191	4-1/2	114	9	229	5/8	16	Centered						RC-5046	RC-5046DK
		7-1/2	191	5	127	5	127	1	25	Centered						RC-2960XD	22-8049DK
		7-1/2	191	5	127	6	152	1	25	Centered				RU-3100	RF-1036	RP-5168	RF-1036DK
		7-1/2	191	5	127	6	152	5/8	16	Centered					RF-1043		22-8037PK
		7-1/2	191	5	127	6-1/2	165	1	25	Centered						RF-1042XD	RF-1042DK
		7-1/2	191	5	127	7-1/2	191	1	25	Centered						RF-1041	RF-1041DK
		7-1/2	191	5	127	8	203	1	25	Centered				RU-3050	RF-1020		RF-1020DK
		7-1/2	191	5	127	8	203	5/8	16	Centered						RF-1044XD	RF-1020DK
		7-1/2	191	5	127	10	254	1	25	Centered				RU-3280			
		7-1/2	191	5-1/8	130	4	102	1	25	Centered						RF-1009	22-8036PK
		7-1/2	191	5-1/8	130	5	127	1	25	Centered						RC-2960	22-8049DK
		7-1/2	191	5-1/4	133	6	152	1	25	Centered				RU-3102HBK			
		7-1/2	191	5-1/4	133	7-1/2	191	1	25	Centered				RU-3101HBK			
		7-1/2	191	5-7/8	149	3	76	1	25	Centered						RF-1028	RF-1028DK
		7-1/2	191	5-7/8	149	6	152	1	25	Centered						RC-4940	RC-5173DK
		7-1/2	191	5-7/8	149	6	152	5/8	16	Centered						RC-5173	RC-5173DK
		7-1/2	191	5-7/8	149	6-1/2	165	1	25	Centered						RF-1014	RF-1014DK
		7-1/2	191	7	178	4	102	1	25	Centered						RF-1010 <sup>2</sup>	
		7-1/2	191	7	178	8	203	1	25	Centered						RF-1017 <sup>2</sup>	22-8050PK
		7-1/2	191	7	178	11	279	1	25	Centered						RF-1026	RF-1026DK
		7-1/2	191	7	178	18	457	1	25	Centered						RC-3070	RC-3070DK
		9	229	6-5/8	168	7-1/2	191	1-1/8	29	Centered				RU-5177HBK		RC-5282 <sup>44</sup>	RC-5139DK

1) 1/4-20 Jack Nut Into Top 2) Base Has (2) 7/8" Vents 3) Base Has 1/2" Vent 4) Base Has 1/32" Vent 5) Base Has 1/4" Vent 6) Base Has 11/16" Vent 7) Base Has 1-1/8" Vent 8) Base Has 13/16" Vent 9) Base Has 13/32" Vent 10) Base Has 13/64" Vent 11) Base Has 2-3/16" Square Inlet 12) Base Has 15/64" Vent 13) Base Has 19/32" Vent 14) Base Has 21/32" Vent 15) Base Has 25/64" Vent 16) Base Has 29/32" Vent 17) Base Has 3/16" Vent 18) Base Has 3/4" Vent 19) Base Has 3/8" Vent 20) Base Has 31/64" Vent 21) Base Has 35/64" Vent 22) Base Has 45/64" Vent 23) Base Has 5/16" Vent 24) Base Has 5/8" Vent 25) Base Has 55/64" Vent 26) Base Has 7/16" Vent 27) Base Has 7/8" Vent 28) Base Has 9/16" Vent 29) Base Has Opt. 1/2" Vent 30) Base Has 23/32" Vent 31) Base Has 25/32" Vent 32) Filter Has Molded-In Velocity Stack 33) Filter Is Reverse Tapered 34) Fits Legend/Dwarf Race Cars w/FJ1200 Motors 35) Base Has 15/32" Vent 36) Top Plate Has 1/4-20 Stud 37) Top-Plate Has 6MM Stud 39) Offset Is Vertical 41) Offset Is Vertical And To The Right 42) Top Has 1/2" Vent 43) Top Has 1-1/16" Center Hole 44) Top Has 21/32" Center Hole 45) Top Has 23/32" Center Hole 46) Top Has 5/32" Center Hole 47) Top Has 7/16" Center Hole 48) Base Has 11/32" Vent 49) Top Has 1/4" Center Hole 50) Top Has 1-7/16" Center Hole 51) 2-1/2" Adapter Included 52) Top Has 5/8" Vent 53) Tapered Insert Included 5" to 4-3/8" 54) Filter Has Thru Hole 2-3/4" x 1-5/8"

# Oval Straight

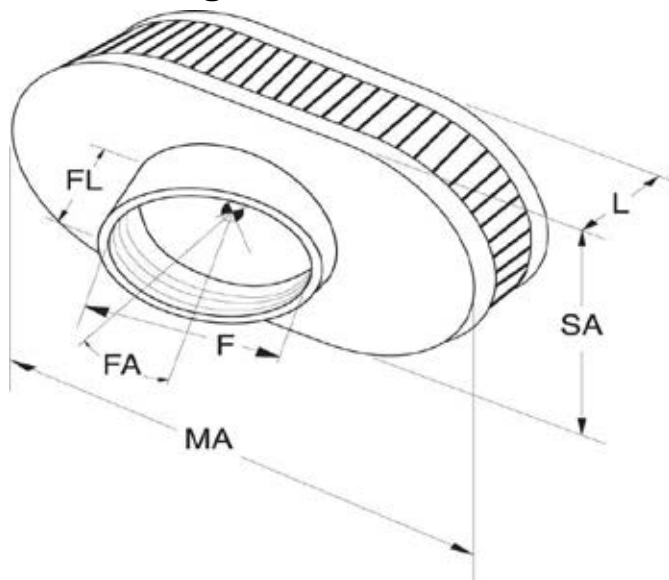

When selecting one of K&N's universal oval air filters, you should consider the following dimensions as they relate to the specification chart:

(F) Mounting Flange Inside Diameter - This is the most critical dimension and should be very close to the diameter of the application's inlet flange. The flange will stretch up to 1/16" for those in-between sizes.

(MA / SA) Filter Oval Dimensions - This is the length and width of the filter. Always use the largest filter practical to fit the application.

(L) Filter Length - This dimension is the length of the filter body only, it does not include the flange length. Always use the longest filter practical for maximum filtration.

(FA / FL) Flange Angle and/or Length - If no angle is listed in the specifications table, then the flange is straight. Any angle listed is in degrees and can be utilized when space is a problem.

(FO) Flange Offset - In some cases the center of the flange is offset from the center of the filter base in order to provide a better fit.

(F) Mounting Flange Inside Diameter		(MA/SA) Filter Dimensions		(L) Filter Length		(FL) Flange Length		(FA) Flange Style		(FO) Flange Offset		Rubber End Cap Part #	Chrome End Cap Part #	Filter Wraps Part #
Inch	mm	Inch	mm	Inch	mm	Inch	mm	Type	Angle	Inch	mm			
1-1/2	38	3-3/4x4-1/2	95x114	2-3/4	70	1	25	Angled	30°			R-0640		
2-1/16	52	4-1/2x7	114x178	1-1/2	38	7/8	22	Offset		1/2	13	RA-0700 <sup>5</sup>	RA-070V <sup>5</sup>	22-2000PL
		4-1/2x7	114x178	2	51	7/8	22	Offset		1/2	13	RA-0710 <sup>5</sup>	RA-071V <sup>5</sup>	22-2000PL
		4-1/2x7	114x178	3	76	7/8	22	Offset		1/2	13	RA-0720 <sup>5</sup>	RA-072V <sup>5</sup>	22-2020PL
2-1/4	57	4x6-1/4	102x159	4-1/2	114	1	25	Angled	10°			RU-1320		
		4x6-1/4	102x159	6	152	1	25	Angled	10°			RU-1330		
		3-3/4x4-1/2	95x114	4	102	5/8	16	Centered				RU-0990		
		3-3/4x4-1/2	95x114	5	127	5/8	16	Centered				RU-1100		
		3-3/4x4-1/2	95x114	5	127	1	25	Angled	10°			RU-1140		
		3-3/4x4-1/2	95x114	6	152	1	25	Angled	10°			RU-1150		RU-1230PK
		3-3/4x4-1/2	95x114	2	51	5/8	16	Centered				R-1390		22-8023PK
2-7/16	62	4x6-1/4	102x159	4-1/2	114	1	25	Angled	10°			RU-1340		
		4x6-1/4	102x159	5	127	1	25	Angled	10°			RU-1350		
		4x6-1/4	102x159	6	152	1	25	Angled	10°			RU-1360		
		4-1/2x7	114x178	2	51	5/8	16	Centered					RC-1980	22-2000PL
		3-1/4x4-3/8	83x111	6-3/4	171	1-1/8	29	Centered				AT-6091		
		3-3/4x4-1/2	95x114	5	127	5/8	16	Centered				RU-1180		
		3-3/4x4-1/2	95x114	5	127	1	25	Angled	10°			RU-1220		
		3-3/4x4-1/2	95x114	5	127	1-1/4	32	Angled	20°			RU-1371 <sup>21</sup>		
		3-3/4x4-1/2	95x114	6	152	1	25	Angled	10°			RU-1230		RU-1230PK
		3-3/4x4-1/2	95x114	6	152	1-1/4	32	Angled	20°			RU-1380		RU-1230PK
		3-3/4x4-1/2	95x114	7	178	5/8	16	Centered				RU-1810		RU-1240PK
		3-3/4x4-1/2	95x114	7	178	1	25	Angled	10°			RU-1240		RU-1240PK
		3-3/4x4-1/2	95x114	7	178	1-1/4	32	Angled	20°			RU-1390		RU-1240PK
3-3/4x4-1/2	95x114	9	229	1	25	Angled	10°			RU-1260		RU-1260PK		
2-1/2	64	3-3/4x4-1/2	95x114	7	178	2-1/8	54	Angled	10°			RU-1830		RU-1240PK

1) 1/4-20 Jack Nut Into Top 2) Base Has (2) 7/8" Vents 3) Base Has 1/2" Vent 4) Base Has 1/32" Vent 5) Base Has 1/4" Vent 6) Base Has 11/16" Vent 7) Base Has 1-1/8" Vent 8) Base Has 13/16" Vent 9) Base Has 13/32" Vent 10) Base Has 13/64" Vent 11) Base Has 2-3/16" Square Inlet 12) Base Has 15/64" Vent 13) Base Has 19/32" Vent 14) Base Has 21/32" Vent 15) Base Has 25/64" Vent 16) Base Has 29/32" Vent 17) Base Has 3/16" Vent 18) Base Has 3/4" Vent 19) Base Has 3/8" Vent 20) Base Has 31/64" Vent 21) Base Has 35/64" Vent 22) Base Has 45/64" Vent 23) Base Has 5/16" Vent 24) Base Has 5/8" Vent 25) Base Has 55/64" Vent 26) Base Has 7/16" Vent 27) Base Has 7/8" Vent 28) Base Has 9/16" Vent 29) Base Has Opt. 1/2" Vent 30) Base Has 23/32" Vent 31) Base Has 25/32" Vent 32) Filter Has Molded-in Velocity Stack 33) Filter Is Reverse Tapered 34) Fits Legend/Dwarf Race Cars w/FJ1200 Motors 35) Base Has 15/32" Vent 36) Top Plate Has 1/4-20 Stud 37) Top-Plate Has 6MM Stud 39) Offset Is Vertical 41) Offset Is Vertical And To The Right 42) Top Has 1/2" Vent 43) Top Has 1-1/16" Center Hole 44) Top Has 21/32" Center Hole 45) Top Has 23/32" Center Hole 46) Top Has 5/32" Center Hole 47) Top Has 7/16" Center Hole 48) Base Has 11/32" Vent 49) Top Has 1/4" Center Hole 50) Top Has 1-7/16" Center Hole 51) 2-1/2" Adapter Included 52) Top Has 5/8" Vent 53) Tapered Insert Included 5" to 4-3/8" 54) Filter Has Thru Hole 2-3/4" x 1-5/8"



# Oval Straight

(F) Mounting Flange Inside Diameter		(MA/SA) Filter Dimensions		(L) Filter Length		(FL) Flange Length		(FA) Flange Style		(FO) Flange Offset		Rubber End Cap Part #	Chrome End Cap Part #	Filter Wraps <sup>14</sup> Part #
Inch	mm	Inch	mm	Inch	mm	Inch	mm	Type	Angle	Inch	mm			
2-1/2	64	3-3/4x4-1/2	95x114	9	229	2-1/8	54	Angled	10°			RU-1840		RU-1260PK
2-9/16	65	4-1/2x7	114x178	1-1/2	38	7/8	22	Offset		1/2	13	RA-0750	RA-075V	22-2000PL
		4-1/2x7	114x178	2	51	7/8	22	Offset		1/2	13	RA-0760	RA-076V	22-2000PL
		4-1/2x7	114x178	3	76	7/8	22	Offset		1/2	13	RA-0770	RA-077V	22-2020PL
2-3/4	70	4x6-1/4	102x159	5	127	5/8	16	Centered				RU-1500	RC-1500	
		4x6-1/4	102x159	5	127	1	25	Angled	10°			RU-1530		
		4x6-1/4	102x159	6	152	1	25	Angled	10°			RU-1540	RC-1540	
		4x6-1/4	102x159	7	178	5/8	16	Centered				RU-1520	RC-1520	
		4x6-1/4	102x159	7	178	1	25	Angled	10°			RU-1550		
		4-1/2x7	114x178	2	51	5/8	16	Centered					RC-2000	22-2000PL
3-1/2	89	4-1/2x7	114x178	7	178	5/8	16	Centered				RU-3620		
		4-1/2x7	114x178	3-1/2	89	5/8	16	Centered					RC-3180	E-3341PK

**PART NUMBER**  
**RU-1840**

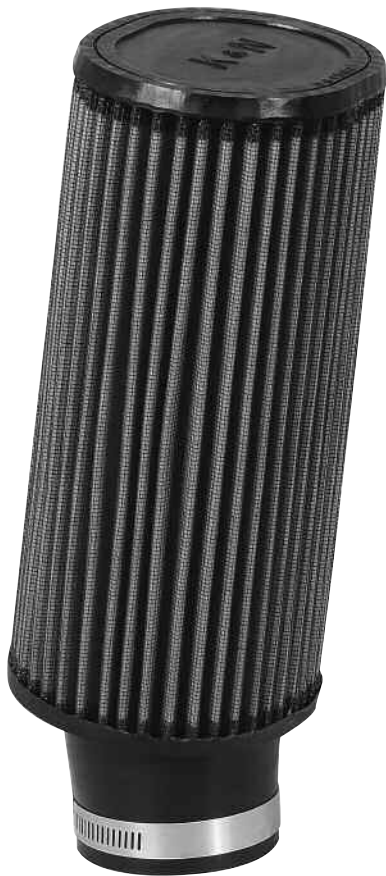

**PART NUMBER**  
**RU-1500**



**PART NUMBER**  
**RU-1390**

1) 1/4-20 Jack Nut Inserted Into Filter Top 2) Base Has (2) 7/8" Vents 3) Base Has 1/2" Vent 4) Base Has 1/32" Vent 5) Base Has 1/4" Vent 6) Base Has 11/16" Vent 7) Base Has 1-1/8" Vent 8) Base Has 13/16" Vent 9) Base Has 13/32" Vent 10) Base Has 13/64" Vent 11) Base Has 15/32" Vent 12) Base Has 15/64" Vent 13) Base Has 19/32" Vent 14) Base Has 21/32" Vent 15) Base Has 25/64" Vent 16) Base Has 29/32" Vent 17) Base Has 3/16" Vent 18) Base Has 3/4" Vent 19) Base Has 3/8" Vent 20) Base Has 31/64" Vent 21) Base Has 35/64" Vent 22) Base Has 45/64" Vent 23) Base Has 5/16" Vent 24) Base Has 5/8" Vent 25) Base Has 55/64" Vent 26) Base Has 7/16" Vent 27) Base Has 7/8" Vent 28) Base Has 9/16" Vent 29) Base Has Optional 1/2" Vent 30) Black Powder Coated Top Plate 31) Carbon Fiber Top Plate 32) Filter Has Molded-in Velocity Stack 33) Filter Is Reverse Tapered 34) Fits "Legend/Dwarf" Race Cars w/FJ1200 Motors 35) Galvanized Top Plate 36) Metal Top Plate Has 1/4-20 Stud 37) Metal Top-Plate Has 6MM Stud 38) Offset Is Horizontal 39) Offset Is Vertical 40) Offset Is Vertical And To The Left 41) Offset Is Vertical And To The Right 42) Top Has 1/2" Vent 43) Top Has 1/4" Center Hole 44) Top Has 1-1/16" Center Hole 45) Top Has 1-7/16" Center Hole 46) Top Has 21/32" Center Hole 47) Top Has 23/32" Center Hole 48) Top Has 5/32" Center Hole 49) Top Has 5/8" Vent 50) Top Has 7/16" Vent 51) Top Has Two 0.400" Vents 52) 2-1/4" Adapter Included 53) Tapered Insert Included 5" to 4-3/8"

# Oval Tapered

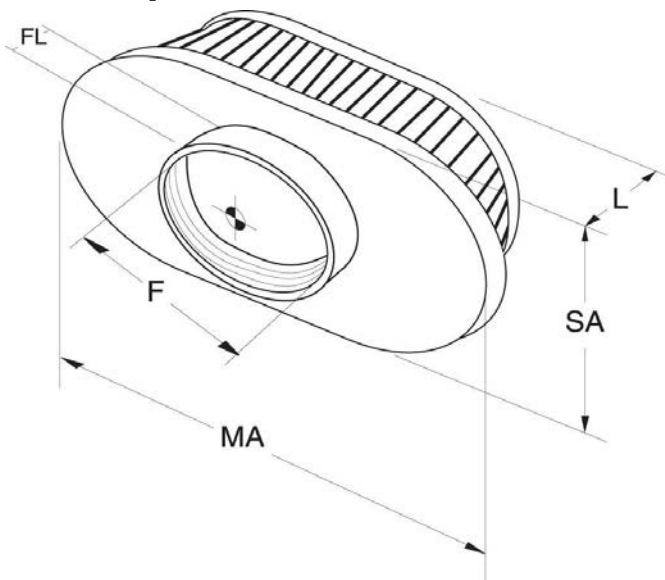

When selecting one of K&N's universal oval air filters, you should consider the following dimensions as they relate to the specification chart:

(F) Mounting Flange Inside Diameter - This is the most critical dimension and should be very close to the diameter of the application's inlet flange. The flange will stretch up to 1/16" for those in-between sizes.

(MA / SA) Filter Oval Dimensions - This is the length and width of the filter. Always use the largest filter practical to fit the application.

(L) Filter Length - This dimension is the length of the filter body only, it does not include the flange length. Always use the longest filter practical for maximum filtration.

(FA / FL) Flange Angle and/or Length - If no angle is listed in the specifications table, then the flange is straight. Any angle listed is in degrees and can be utilized when space is a problem.

(FO) Flange Offset - In some cases the center of the flange is offset from the center of the filter base in order to provide a better fit.

(F) Mounting Flange Inside Diameter		(MA/SA) Filter Base Dimensions		(MA/SA) Filter Top Dimensions		(L) Filter Length		(FL) Flange Length		(FA) Flange Style	(FO) Flange Offset	Rubber End Cap Part #	Chrome End Cap Part #	Custom End Cap Part #	Filter Wraps Part #
Inch	mm	Inch	mm	Inch	mm	Inch	mm	Inch	mm	Type Angle	Inch mm	Part #	Part #	Part #	Part #
														RG-1003F	
1-3/4	44	2-7/8x4	73x102	2x3	51x76	2-3/4	70	5/8	16	Offset	1/2 13		RC-2450 <sup>7</sup>		RC-1820DK
		3x4	76x102	2-1/2x3-1/2	64x89	2-3/4	70	5/8	16	Offset	1/2 13	RU-2450 <sup>7</sup>			RU-0981DK
2	51	3x4	76x102	2x3	51x76	2-3/4	70	5/8	16	Offset	1/2 13		RC-1820 <sup>7</sup>		RC-1820DK
		3x4	76x102	2x3	51x76	5	127	5/8	16	Offset	1/2 13		RC-2770 <sup>7</sup>		
		3x4	76x102	2-1/2x3-1/2	64x89	2-3/4	70	5/8	16	Offset	1/2 13	RU-1820 <sup>7</sup>			RU-0981DK
2-1/8	54	2-7/8x4	73x102	2-1/2x3-1/2	64x89	4	102	5/8	16	Offset	7/16 11	RU-2980 <sup>7</sup>			
		3x4	76x102	2x3	51x76	2-3/4	70	5/8	16	Offset	7/16 11		RC-0981		RC-1820DK
		3x4	76x102	2x3	51x76	4	102	5/8	16	Offset	7/16 11		RC-2900 <sup>7</sup>		RC-2890DK
		3x4	76x102	2-1/2x3-1/2	64x89	2-3/4	70	5/8	16	Offset	7/16 11	RU-3010 <sup>9</sup>			RU-0981DK
		3x4	76x102	2-1/2x3-1/2	64x89	4	102	5/8	16	Offset	7/16 11	RU-2810 <sup>7</sup>			
		3x4	76x102	2-1/2x3-1/2	64x89	5	127	5/8	16	Offset	7/16 11	RU-2750 <sup>7</sup>			
2-3/8	60	3-1/2x4-7/8	89x124	2x3	51x76	5-1/2	140	7/8	22	Centered			RC-70040		
		4-1/2x5-3/16	114x132	3-5/16x3-1/2	84x89	4-13/32	112	3/4	19	Offset	5/8 16		RC-70032 <sup>4</sup>		
2-7/16	62	3-3/4x4-1/2	95x114	2x3	51x76	4	102							RE-0961	
		3-3/4x4-1/2	95x114	2x3	51x76	6	152	5/8	16	Centered			RC-3680		22-8051PK
		3-3/4x4-1/2	95x114	2-1/2x3-1/2	64x89	2-3/4	70	5/8	16	Centered		RU-2780 <sup>7</sup>			RU-2780DK
		3-3/4x4-1/2	95x114	2-1/2x3-1/2	64x89	3-1/2	89	5/8	16	Centered		RU-3780			
		3-3/4x4-1/2	95x114	2-1/2x3-1/2	64x89	5	127	1-1/4	32	Angled 20°		SN-2540			SN-2540PK
		3-3/4x4-1/2	95x114	2-1/2x3-1/2	64x89	6	152	1-1/4	32	Angled 20°		SN-2550			SN-2550PK
		3-3/4x4-1/2	95x114	2-1/2x3-1/2	64x89	6	152	5/8	16	Centered				RE-0960	
		3-3/4x4-1/2	95x114	2-1/2x3-1/2	64x89	7	178	1-1/4	32	Angled 20°		SN-2560			SN-2560DK
2-1/2	64	4-7/32x4-17/32	107x115	3-5/16x4-7/16	84x113	5-1/2	140	2-7/16	62	Angled 9°			RC-70050		
2-3/4	70	3-3/4x4-3/4	95x121	4x4	102x102	5-9/16	141	13/16	21	Centered				RX-5090 <sup>1</sup>	
3	76	6x8	152x203	5x5	127x127	6-1/2	165	1-7/8	48	Centered				RX-4750 <sup>1</sup>	RF-1042DK

1) 1/4-20 Jack Nut Into Top 2) Base Has (2) 7/8" Vents 3) Base Has 1/2" Vent 4) Base Has 1/32" Vent 5) Base Has 1/4" Vent 6) Base Has 11/16" Vent 7) Base Has 1-1/8" Vent 8) Base Has 13/16" Vent 9) Base Has 13/32" Vent 10) Base Has 13/64" Vent 11) Base Has 2-3/16" Square Inlet 12) Base Has 15/64" Vent 13) Base Has 19/32" Vent 14) Base Has 21/32" Vent 15) Base Has 25/64" Vent 16) Base Has 29/32" Vent 17) Base Has 3/16" Vent 18) Base Has 3/4" Vent 19) Base Has 3/8" Vent 20) Base Has 31/64" Vent 21) Base Has 35/64" Vent 22) Base Has 45/64" Vent 23) Base Has 5/16" Vent 24) Base Has 5/8" Vent 25) Base Has 55/64" Vent 26) Base Has 7/16" Vent 27) Base Has 7/8" Vent 28) Base Has 9/16" Vent 29) Base Has Opt. 1/2" Vent 30) Base Has 23/32" Vent 31) Base Has 25/32" Vent 32) Filter Has Molded-in Velocity Stack 33) Filter Is Reverse Tapered 34) Fits Legend/Dwarf Race Cars w/FJ1200 Motors 35) Base Has 15/32" Vent 36) Top Plate Has 1/4-20 Stud 37) Top Plate Has 6MM Stud 39) Offset Is Vertical 41) Offset Is Vertical And To The Right 42) Top Has 1/2" Vent 43) Top Has 1-1/16" Center Hole 44) Top Has 21/32" Center Hole 45) Top Has 23/32" Center Hole 46) Top Has 5/32" Center Hole 47) Top Has 7/16" Center Hole 48) Base Has 11/32" Vent 49) Top Has 1/4" Center Hole 50) Top Has 1-7/16" Center Hole 51) 2-1/2" Adapter Included 52) Top Has 5/8" Vent 53) Tapered Insert Included 5" to 4-3/8" 54) Filter Has Thru Hole 2-3/4" x 1-5/8"

# Oval Tapered

(F) Mounting Flange Inside Diameter		(MA/SA) Filter Base Dimensions		(MA/SA) Filter Top Dimensions		(L) Filter Length		(FL) Flange Length		(FA) Flange Style	(FO) Flange Offset	Rubber End Cap Part #	Chrome End Cap Part #	Custom End Cap Part #	Filter Wraps Part #
Inch	mm	Inch	mm	Inch	mm	Inch	mm	Inch	mm	Type Angle	Inch mm				
3-1/2	89	5-1/4x8-1/2	133x216	4x6-1/4	102x159	5-1/2	140	3/4	19	Centered			RC-5040		RC-5040DK
		5-3/4x5-3/4	146x146	3-1/4x4-1/2	83x114	6	152	1-3/4	44	Angled 10°			RC-4400		
		5-3/4x5-3/4	146x146	3-1/4x4-1/2	83x114	7	178	1-3/4	44	Angled 10°				RF-1033	
		6x6	152x152	3-3/4x4-1/2	95x114	5	127	1-3/4	44	Centered		RU-4190			
3-11/16	94	5-1/2x8-3/4	140x222	3-3/16x6-3/8	81x162	7	178	2-1/8	54	Centered				RP-5285	
3-9/17	199	5-3/8x7-1/2	137x191	3-5/16x4-7/16	84x113	6-1/2	165	1-3/8	35	Centered				RC-5152	
3-29/32	99	5-1/2x7-1/2	140x191	3-5/16x4-1/2	84x114	6-1/2	165	1-1/2	38	Centered				RC-5132	
3-15/16	100	5-1/4x6-15/16	133x176	3-1/4x4-1/2	83x114	4-15/16	125	1-15/32	37	Centered			RC-1681 <sup>26</sup>		
		5-5/16x6-7/8	135x175	3-1/4x4-1/2	83x114	5	127	1-1/2	38	Centered			RC-70031		RC-70031DI
		5-5/16x6-11/16	135x170	3-1/4x4-1/2	83x114	5	127	1-15/32	37	Centered			RC-1605 <sup>5</sup>		
		5-5/16x7-1/8	135x181	3-1/4x4-1/2	83x114	5	127	1-7/16	37	Centered			RC-5129 <sup>3</sup>		
		5-5/16x7-1/8	135x181	3-1/2x3-1/2	89x89	5	127	1-15/16	49	Centered			RC-5056 <sup>37,3</sup>		
		5-3/8x7-1/2	137x191	3-5/16x4-7/16	84x113	4-3/4	121	1-7/16	37	Centered			RC-1680 <sup>5,18</sup>		
		5-7/16x7-7/16	138x189	3-1/4x4-7/16	83x113	4-13/16	122	1-7/16	37	Centered			RC-70002 <sup>24</sup>		
		5-7/16x7-7/16	138x189	3-1/4x4-7/16	83x113	6-3/4	171	1-7/16	37	Centered			RC-1677 <sup>18,3</sup>		
		5-7/16x7-7/16	138x189	4-1/2x4-1/2	114x114	6-13/16	173	1-7/16	37	Centered			RC-70030 <sup>3</sup>		
		5-7/16x7-7/16	138x189	4-1/2x4-1/2	114x114	6-7/8	175	1-7/16	37	Centered			RC-5055 <sup>19</sup>		
4	102	5-3/8x7-1/2	137x191	3-5/16x4-1/2	84x114	8-1/16	205	1-3/8	35	Centered				RC-5126	
		5-3/4x9	146x229	4-1/2x7	114x178	4	102	1-1/2	38	Centered				RC-5148	
		5-3/4x9	146x229	4-1/2x7	114x178	7-1/2	191	1-1/2	38	Centered				RF-1040	RF-1034DK
		5-3/4x9	146x229	4-1/2x7	114x178	7-1/2	191	5/8	16	Centered				RF-1034	RF-1034DK
		6-3/4x9-1/2	171x241	5-1/2x9	140x229	8-15/16	227	1-7/8	48	Offset	1-1/2 38			RC-5102 <sup>2,29</sup>	RC-5102DK
4-1/2	114	5-7/8x5-7/8	149x149	3-1/4x4-1/2	83x114	8	203	5/8	16	Centered				RF-1021	
		6-1/4x9-1/4	159x235	4-1/2x7	114x178	10	254	5/8	16	Centered				RF-1024 <sup>3</sup>	RF-1024DK
6	152	6-1/4x8-1/4	159x210	4x6-1/4	102x159	5	127	1	25	Centered			RC-3160		
		6-1/4x8-1/4	159x210	4-1/2x7	114x178	3-1/4	83	1	25	Centered				RF-1002	

**PART NUMBER**  
RC-5132



**PART NUMBER**  
RE-0960



1) 1/4-20 Jack Nut Into Top 2) Base Has (2) 7/8" Vents 3) Base Has 1/2" Vent 4) Base Has 1/32" Vent 5) Base Has 1/4" Vent 6) Base Has 11/16" Vent 7) Base Has 1-1/8" Vent 8) Base Has 13/16" Vent 9) Base Has 13/32" Vent 10) Base Has 13/64" Vent 11) Base Has 2-3/16" Square Inlet 12) Base Has 15/64" Vent 13) Base Has 19/32" Vent 14) Base Has 21/32" Vent 15) Base Has 25/64" Vent 16) Base Has 29/32" Vent 17) Base Has 3/16" Vent 18) Base Has 3/4" Vent 19) Base Has 3/8" Vent 20) Base Has 31/64" Vent 21) Base Has 35/64" Vent 22) Base Has 45/64" Vent 23) Base Has 5/16" Vent 24) Base Has 5/8" Vent 25) Base Has 55/64" Vent 26) Base Has 7/16" Vent 27) Base Has 7/8" Vent 28) Base Has 9/16" Vent 29) Base Has Opt. 1/2" Vent 30) Base Has 23/32" Vent 31) Base Has 25/32" Vent 32) Filter Has Molded-in Velocity Stack 33) Filter Is Reverse Tapered 34) Fits Legend/Dwarf Race Cars w/FJ1200 Motors 35) Base Has 15/32" Vent 36) Top Plate Has 1/4-20 Stud 37) Top-Plate Has 6MM Stud 39) Offset Is Vertical 41) Offset Is Vertical And To The Right 42) Top Has 1/2" Vent 43) Top Has 1-1/16" Center Hole 44) Top Has 21/32" Center Hole 45) Top Has 23/32" Center Hole 46) Top Has 5/32" Center Hole 47) Top Has 7/16" Center Hole 48) Base Has 11/32" Vent 49) Top Has 1/4" Center Hole 50) Top Has 1-7/16" Center Hole 51) 2-1/2" Adapter Included 52) Top Has 5/8" Vent 53) Tapered Insert Included 5" to 4-3/8" 54) Filter has Thru Hole 2-3/4" x 1-5/8"

# AIR FILTER WRAPS

## FOR ADDED PROTECTION

### DRYCHARGER® AND PRECHARGER® WRAPS - ROUND STRAIGHT

I.D.	HEIGHT	DESCRIPTION	PART#
2" (51mm)	3" (76mm)	Dry-Black	62-1300DK
2.75" (70mm)	2.813" (71mm)	Dry-Black	E-4142DK
3" (76mm)	12.5" (318mm)	Dry-Black	E-3810DK
3" (76mm)	2.5" (64mm)	Pre-Black	RU-0150PK
3" (76mm)	3" (76mm)	Pre-Black	22-8008PK
3" (76mm)	4" (102mm)	Pre-Black	22-8009PK
3" (76mm)	5" (127mm)	Pre-Black	RU-0210PK
3" (76mm)	6" (152mm)	Pre-Black	22-8010PK
3.25" (83mm)	7.063" (179mm)	Dry-Black	E-4510DK
3.25" (83mm)	2.5" (64mm)	Pre-Black	22-8007PK
3.25" (83mm)	3.5" (89mm)	Pre-Black	AC-3098PK
3.313" (84mm)	5.5" (140mm)	Pre-Black	YA-2597PK
3.5" (89mm)	1.5" (38mm)	Dry-Black	RC-0170DK
3.5" (89mm)	4" (102mm)	Pre-Black	RU-0500PK
3.5" (89mm)	5" (127mm)	Pre-Black	RU-0510PK
3.5" (89mm)	5" (127mm)	Pre-Blue	RU-0510PL
3.5" (89mm)	5" (127mm)	Pre-Red	RU-0510PR
3.5" (89mm)	5" (127mm)	Pre-Yellow	RU-0510PY
3.5" (89mm)	6" (152mm)	Pre-Black	RU-0520PK
3.625" (92mm)	9" (229mm)	Pre-Black	YA-4350PK
3.875" (98mm)	4.25" (108mm)	Pre-Red	HA-3098PR
3.875" (98mm)	4.313" (110mm)	Pre-Red	HA-2090PR
3.875" (98mm)	5.875" (149mm)	Pre-Black	YA-3504PK
3.938" (100mm)	5.625" (143mm)	Pre-Black	YA-4001PK
4" (102mm)	7" (178mm)	Dry-Black	PL-5006DK
4" (102mm)	4" (102mm)	Pre-Black	22-8011PK
4" (102mm)	4.25" (108mm)	Pre-Black	PL-1004PK
4" (102mm)	5" (127mm)	Pre-Black	RU-1460PK
4" (102mm)	6" (152mm)	Pre-Black	RU-1470PK
4" (102mm)	7" (178mm)	Pre-Black	PL-1003PK
4" (102mm)	7" (178mm)	Pre-Black	RU-1480PK
4.5" (114mm)	4" (102mm)	Dry-Black	RB-0900DK
4.5" (114mm)	3.563" (90mm)	Pre-Blue	KA-2288PL
4.5" (114mm)	3.625" (92mm)	Pre-Blue	KA-4093PL
4.5" (114mm)	4" (102mm)	Pre-Black	22-8012PK
4.5" (114mm)	5" (127mm)	Pre-Black	22-8013PK
4.5" (114mm)	6" (152mm)	Pre-Red	HA-4504PR
4.625" (117mm)	5" (127mm)	Pre-Red	HA-3094PR
4.75" (121mm)	4.625" (117mm)	Pre-Black	HA-5000PK
5" (127mm)	5" (127mm)	Dry-Black	RC-5182DK
5" (127mm)	5.5" (140mm)	Dry-Black	CM-4508DK
5" (127mm)	6.625" (168mm)	Dry-Black	KA-4508DK
5" (127mm)	7.25" (184mm)	Dry-Black	PL-8007DK
5" (127mm)	3.688" (94mm)	Pre-Yellow	SU-4250PY
5" (127mm)	4" (102mm)	Pre-Black	22-8014PK

I.D.	HEIGHT	DESCRIPTION	PART#
5" (127mm)	5" (127mm)	Pre-Black	RU-2430PK
5" (127mm)	6" (152mm)	Pre-Black	YA-4504PK
5" (127mm)	7" (178mm)	Pre-Black	22-8044PK
5.25" (133mm)	4.75" (121mm)	Dry-Black	SU-7005DK
5.25" (133mm)	6.25" (159mm)	Dry-Black	AC-1012DK
5.5" (140mm)	2.25" (57mm)	Dry-Black	E-4665DK
5.5" (140mm)	5.5" (140mm)	Dry-Black	KA-7508DK
5.5" (140mm)	3" (76mm)	Pre-Black	22-8015PK
5.5" (140mm)	5" (127mm)	Pre-Black	22-8016PK
6" (152mm)	6" (152mm)	Dry-Black	22-8045DK
6" (152mm)	1.75" (44mm)	Pre-Black	E-3211PK
6" (152mm)	1.75" (44mm)	Pre-Blue	E-3211PL
6" (152mm)	1.75" (44mm)	Pre-Red	E-3211PR
6" (152mm)	12" (305mm)	Pre-Black	22-8046PK
6" (152mm)	2" (51mm)	Pre-Black	22-8017PK
6" (152mm)	3.25" (83mm)	Pre-Black	E-3190PK
6" (152mm)	3.25" (83mm)	Pre-Blue	E-3190PL
6" (152mm)	3.25" (83mm)	Pre-Red	E-3190PR
6" (152mm)	3.25" (83mm)	Pre-Yellow	E-3190PY
6" (152mm)	3.5" (89mm)	Pre-Black	22-8018PK
6.188" (157mm)	7.563" (192mm)	Dry-Black	E-4710DK
6.25" (159mm)	1.5" (38mm)	Dry-Black	RC-3028DK
6.25" (159mm)	1.5" (38mm)	Dry-Blue	RC-3028DL
6.25" (159mm)	1.5" (38mm)	Dry-Red	RC-3028DR
6.25" (159mm)	1.5" (38mm)	Dry-Yellow	RC-3028DY
7" (178mm)	2" (51mm)	Dry-Black	E-4521DK
7" (178mm)	2.25" (57mm)	Dry-Black	E-4518DK
7" (178mm)	2" (51mm)	Pre-Black	E-3360PK
7" (178mm)	2" (51mm)	Pre-Red	E-3360PR
7" (178mm)	2" (51mm)	Pre-Yellow	E-3360PY
7" (178mm)	3" (76mm)	Pre-Black	E-3380PK
7" (178mm)	3" (76mm)	Pre-Blue	E-3380PL
7" (178mm)	3" (76mm)	Pre-Red	E-3380PR
7" (178mm)	3" (76mm)	Pre-Black	RU-0980PK
7" (178mm)	4" (102mm)	Pre-Black	22-8019PK
7" (178mm)	4" (102mm)	Pre-Black	E-2510PK
7" (178mm)	4" (102mm)	Pre-Blue	E-2510PL
7" (178mm)	4" (102mm)	Pre-Red	E-2510PR
7" (178mm)	4" (102mm)	Pre-Yellow	E-2510PY
7" (178mm)	5" (127mm)	Pre-Black	22-8020PK
7" (178mm)	6" (152mm)	Pre-Black	22-8021PK
7" (178mm)	9" (229mm)	Pre-Black	22-8022PK
7.5" (191mm)	2.25" (57mm)	Pre-Black	RK-3901PK
7.625" (194mm)	10" (254mm)	Dry-Red	RU-3270DR

### DRYCHARGER® AND PRECHARGER® WRAPS - ROUND TAPERED

BASE I.D.	TOP I.D.	HEIGHT	DESC.	PART#
2.25" (57mm)	2" (51mm)	2.5" (64mm)	Pre-Black	RC-2540PK
2.5" (64mm)	2" (51mm)	2.25" (57mm)	Pre-Black	RC-0790PK
3" (76mm)	2" (51mm)	3" (76mm)	Pre-Black	22-8028PK
3" (76mm)	2" (51mm)	4" (102mm)	Pre-Black	22-8048PK
3.5" (89mm)	2" (51mm)	4" (102mm)	Pre-Black	RC-1200PK
3.75" (95mm)	2" (51mm)	5" (127mm)	Pre-Black	22-8029PK
3.875" (98mm)	3.5" (89mm)	3.813" (97mm)	Pre-Red	HA-3500PR
4" (102mm)	3.75" (95mm)	1.5" (38mm)	Dry-Black	59-2045DK
4" (102mm)	2" (51mm)	6" (152mm)	Dry-Black	22-8030DK
4.313" (110mm)	4.25" (108mm)	5.313" (135mm)	Pre-Black	KA-3603PK
4.375" (111mm)	4.5" (114mm)	4.5" (114mm)	Pre-Red	HA-2504PR
4.5" (114mm)	3.5" (89mm)	2.5" (64mm)	Dry-Red	22-2042PR
4.5" (114mm)	3" (76mm)	4" (102mm)	Dry-Blue	22-2040PL
4.5" (114mm)	3" (76mm)	4" (102mm)	Dry-Red	22-2040PR
4.5" (114mm)	3.5" (89mm)	4" (102mm)	Pre-Black	AC-4096PK

BASE I.D.	TOP I.D.	HEIGHT	DESC.	PART#
4.5" (114mm)	3.5" (89mm)	5.375" (137mm)	Pre-Black	SU-4002PK
4.5" (114mm)	4" (102mm)	6.125" (156mm)	Pre-Black	RX-3820PK
4.5" (114mm)	4" (102mm)	6.125" (156mm)	Pre-Red	RX-3820PR
4.5" (114mm)	4" (102mm)	6.5" (165mm)	Pre-Black	22-8031PK
4.625" (117mm)	3.75" (95mm)	3.438" (87mm)	Pre-Black	22-8088PK
4.625" (117mm)	3.5" (89mm)	6.75" (171mm)	Pre-Black	YA-3502PK
4.688" (119mm)	3.5" (89mm)	4.875" (124mm)	Dry-Black	RC-9350DK
4.688" (119mm)	3.5" (89mm)	4.875" (124mm)	Dry-Blue	RC-9350DL
4.688" (119mm)	3.5" (89mm)	4.875" (124mm)	Dry-Red	RC-9350DR
4.688" (119mm)	3.5" (89mm)	4.875" (124mm)	Dry-Yellow	RC-9350DY
4.75" (121mm)	4.5" (114mm)	4.75" (121mm)	Dry-Black	HA-6806DK
4.75" (121mm)	3.5" (89mm)	5.875" (149mm)	Dry-Black	RC-9310DK
4.75" (121mm)	3.5" (89mm)	7" (178mm)	Dry-Black	RU-3130DK
4.75" (121mm)	3.5" (89mm)	6" (152mm)	Pre-Red	HA-4250PR
5" (127mm)	4" (102mm)	6" (152mm)	Dry-Black	PL-5207DK

# AIR FILTER WRAPS FOR ADDED PROTECTION

## DRYCHARGER® AND PRECHARGER® WRAPS - ROUND TAPERED CONTINUED

BASE I.D.	TOP I.D.	HEIGHT	DESC.	PART#	BASE I.D.	TOP I.D.	HEIGHT	DESC.	PART#
5" (127mm)	4" (102mm)	6" (152mm)	Dry-Black	RC-4650DK	6" (152mm)	4.5" (114mm)	9" (229mm)	Dry-Black	RC-3690DK
5" (127mm)	4" (102mm)	6" (152mm)	Dry-Blue	RC-4650DL	6" (152mm)	4.5" (114mm)	9" (229mm)	Dry-Blue	RC-3690DL
5" (127mm)	4" (102mm)	6" (152mm)	Dry-Red	RC-4650DR	6" (152mm)	4.5" (114mm)	9" (229mm)	Dry-Red	RC-3690DR
5" (127mm)	4" (102mm)	6" (152mm)	Dry-Yellow	RC-4650DY	6" (152mm)	4.5" (114mm)	9" (229mm)	Dry-Yellow	RC-3690DY
5" (127mm)	4" (102mm)	7.875" (200mm)	Dry-Black	RC-4690DK	6" (152mm)	4.625" (117mm)	12" (305mm)	Pre-Black	22-8034PK
5" (127mm)	4" (102mm)	7.875" (200mm)	Dry-Blue	RC-4690DL	6" (152mm)	4.625" (117mm)	14" (356mm)	Pre-Black	22-8035PK
5" (127mm)	4" (102mm)	7.875" (200mm)	Dry-Red	RC-4690DR	6" (152mm)	4.625" (117mm)	6" (152mm)	Pre-Black	22-8033PK
5" (127mm)	4" (102mm)	7.875" (200mm)	Dry-Yellow	RC-4690DY	6" (152mm)	4.625" (117mm)	9" (229mm)	Pre-Black	RE-0810PK
5" (127mm)	4.5" (114mm)	4.5" (114mm)	Pre-Red	HA-4400PR	6.125" (156mm)	5.125" (130mm)	3.938" (100mm)	Dry-Black	SU-4506DK
5" (127mm)	4" (102mm)	7" (178mm)	Pre-Black	22-8032PK	6.25" (159mm)	5.5" (140mm)	2.125" (54mm)	Dry-Black	HD-0800DK
5" (127mm)	4.75" (121mm)	8" (203mm)	Pre-Black	RE-0910PK	6.25" (159mm)	4.375" (111mm)	4.125" (105mm)	Dry-Black	RU-5163DK
5.125" (130mm)	3.5" (89mm)	6" (152mm)	Dry-Black	RC-4160DK	6.313" (160mm)	5.438" (138mm)	3" (76mm)	Pre-Black	SU-4000PK
5.125" (130mm)	4.5" (114mm)	4.188" (106mm)	Pre-Red	HA-3093PR	6.5" (165mm)	4.5" (114mm)	5.5" (140mm)	Dry-Black	RU-5147DK
5.25" (133mm)	3" (76mm)	6" (152mm)	Dry-Blue	22-2030PL	6.5" (165mm)	4.5" (114mm)	6" (152mm)	Dry-Black	RC-5060DK
5.25" (133mm)	3" (76mm)	6" (152mm)	Dry-Red	22-2030PR	6.5" (165mm)	4.5" (114mm)	6" (152mm)	Dry-Blue	RC-5060DL
5.375" (137mm)	4" (102mm)	5.5" (140mm)	Dry-Black	RP-4660DK	6.5" (165mm)	4.5" (114mm)	6" (152mm)	Dry-Red	RC-5060DR
5.375" (137mm)	4" (102mm)	5.5" (140mm)	Dry-Blue	RP-4660DL	6.5" (165mm)	4.5" (114mm)	6" (152mm)	Dry-Yellow	RC-5060DY
5.375" (137mm)	4" (102mm)	5.5" (140mm)	Dry-Red	RP-4660DR	6.5" (165mm)	5" (127mm)	6.5" (165mm)	Dry-Black	RF-1037DK
5.375" (137mm)	4" (102mm)	5.5" (140mm)	Dry-Yellow	RP-4660DY	6.5" (165mm)	5" (127mm)	6.5" (165mm)	Dry-Blue	RF-1037DL
5.375" (137mm)	4" (102mm)	6.5" (165mm)	Dry-Black	RC-5149DK	6.5" (165mm)	5" (127mm)	6.5" (165mm)	Dry-Red	RF-1037DR
5.375" (137mm)	4.375" (111mm)	7" (178mm)	Dry-Black	RU-2590DK	6.5" (165mm)	5" (127mm)	6.5" (165mm)	Dry-Yellow	RF-1037DY
5.375" (137mm)	4.375" (111mm)	3.5" (89mm)	Pre-Red	HA-2440PR	6.5" (165mm)	4.5" (114mm)	7" (178mm)	Dry-Black	RF-1032DK
5.5" (140mm)	4.5" (114mm)	6.5" (165mm)	Dry-Black	RC-4630DK	6.5" (165mm)	4.5" (114mm)	7" (178mm)	Dry-Blue	RF-1032DL
5.5" (140mm)	4.5" (114mm)	6.5" (165mm)	Dry-Blue	RC-4630DL	6.5" (165mm)	4.5" (114mm)	7" (178mm)	Dry-Red	RF-1032DR
5.5" (140mm)	4.5" (114mm)	6.5" (165mm)	Dry-Red	RC-4630DR	6.5" (165mm)	4.5" (114mm)	7" (178mm)	Dry-Yellow	RF-1032DY
5.5" (140mm)	4.5" (114mm)	6.5" (165mm)	Dry-Yellow	RC-4630DY	6.5" (165mm)	4.5" (114mm)	8" (203mm)	Dry-Black	RF-1027DK
5.5" (140mm)	4" (102mm)	8" (203mm)	Dry-Black	RF-1045DK	6.5" (165mm)	4.5" (114mm)	8" (203mm)	Dry-Blue	RF-1027DL
5.5" (140mm)	4" (102mm)	8" (203mm)	Dry-Blue	RF-1045DL	6.5" (165mm)	4.5" (114mm)	8" (203mm)	Dry-Red	RF-1027DR
5.5" (140mm)	4" (102mm)	8" (203mm)	Dry-Red	RF-1045DR	6.5" (165mm)	4.5" (114mm)	8" (203mm)	Dry-Yellow	RF-1027DY
5.5" (140mm)	4" (102mm)	8" (203mm)	Dry-Yellow	RF-1045DY	6.625" (168mm)	5.25" (133mm)	9.5" (241mm)	Dry-Black	RC-4780DK
5.75" (146mm)	4.5" (114mm)	6" (152mm)	Dry-Black	RF-1023DK	6.625" (168mm)	6.25" (159mm)	9.5" (241mm)	Dry-Blue	RC-4780DL
5.75" (146mm)	4.5" (114mm)	6" (152mm)	Dry-Blue	RF-1023DL	6.625" (168mm)	5.25" (133mm)	9.5" (241mm)	Dry-Red	RC-4780DR
5.75" (146mm)	4.5" (114mm)	6" (152mm)	Dry-Red	RF-1023DR	6.625" (168mm)	5.25" (133mm)	9.5" (241mm)	Dry-Yellow	RC-4780DY
5.75" (146mm)	3.5" (89mm)	6" (152mm)	Dry-Black	RF-1035DK	6.75" (171mm)	5.875" (149mm)	9.5" (241mm)	Dry-Black	RU-5045DK
5.75" (146mm)	3.5" (89mm)	6" (152mm)	Dry-Blue	RF-1035DL	7" (178mm)	3.75" (95mm)	1" (25mm)	Dry-Black	E-2435DK
5.75" (146mm)	3.5" (89mm)	6" (152mm)	Dry-Red	RF-1035DR	7.375" (187mm)	6.625" (168mm)	7.875" (200mm)	Dry-Black	RC-4900DK
5.75" (146mm)	3.5" (89mm)	6" (152mm)	Dry-Yellow	RF-1035DY	7.375" (187mm)	6.625" (168mm)	7.875" (200mm)	Dry-Blue	RC-4900DL
5.813" (148mm)	4" (102mm)	6" (152mm)	Dry-Black	RU-5168DK	7.375" (187mm)	6.625" (168mm)	7.875" (200mm)	Dry-Red	RC-4900DR
5.875" (149mm)	4.938" (125mm)	4" (102mm)	Pre-Yellow	SU-5098PY	7.375" (187mm)	6.625" (168mm)	7.875" (200mm)	Dry-Yellow	RC-4900DY
5.875" (149mm)	5" (127mm)	6" (152mm)	Pre-Black	RU-3480PK	7.5" (191mm)	7" (178mm)	11" (279mm)	Dry-Black	RF-1026DK
6" (152mm)	5" (127mm)	5.563" (141mm)	Dry-Black	RX-4990DK	7.5" (191mm)	7" (178mm)	11" (279mm)	Dry-Blue	RF-1026DL
6" (152mm)	5" (127mm)	5.563" (141mm)	Dry-Blue	RX-4990DL	7.5" (191mm)	7" (178mm)	11" (279mm)	Dry-Red	RF-1026DR
6" (152mm)	5" (127mm)	5.563" (141mm)	Dry-Red	RX-4990DR	7.5" (191mm)	7" (178mm)	18" (457mm)	Dry-Black	RC-3070DK
6" (152mm)	5" (127mm)	5.563" (141mm)	Dry-Yellow	RX-4990DY	7.5" (191mm)	5.875" (149mm)	3" (76mm)	Dry-Black	RF-1028DK
6" (152mm)	5" (127mm)	6.5" (165mm)	Dry-Black	RX-4730DK	7.5" (191mm)	5.875" (149mm)	3" (76mm)	Dry-Blue	RF-1028DL
6" (152mm)	5" (127mm)	6.5" (165mm)	Dry-Blue	RX-4730DL	7.5" (191mm)	5.875" (149mm)	3" (76mm)	Dry-Red	RF-1028DR
6" (152mm)	5" (127mm)	6.5" (165mm)	Dry-Red	RX-4730DR	7.5" (191mm)	5.875" (149mm)	3" (76mm)	Dry-Yellow	RF-1028DY
6" (152mm)	5" (127mm)	6.5" (165mm)	Dry-Yellow	RX-4730DY	7.5" (191mm)	5" (127mm)	4" (102mm)	Dry-Black	RF-1009DK
6" (152mm)	4" (102mm)	6.75" (171mm)	Dry-Black	RC-4700DK	7.5" (191mm)	5" (127mm)	4" (102mm)	Dry-Blue	RF-1009DL
6" (152mm)	4" (102mm)	6.75" (171mm)	Dry-Blue	RC-4700DL	7.5" (191mm)	5" (127mm)	4" (102mm)	Dry-Red	RF-1009DR
6" (152mm)	4" (102mm)	6.75" (171mm)	Dry-Red	RC-4700DR	7.5" (191mm)	5" (127mm)	4" (102mm)	Dry-Yellow	RF-1009DY
6" (152mm)	4" (102mm)	6.75" (171mm)	Dry-Yellow	RC-4700DY	7.5" (191mm)	5" (127mm)	5" (127mm)	Dry-Black	22-8049DK
6" (152mm)	5" (127mm)	7" (178mm)	Dry-Black	RC-5100DK	7.5" (191mm)	5.875" (149mm)	6" (152mm)	Dry-Black	RC-5173DK
6" (152mm)	5" (127mm)	7" (178mm)	Dry-Blue	RC-5100DL	7.5" (191mm)	5" (127mm)	6" (152mm)	Dry-Black	RF-1036DK
6" (152mm)	5" (127mm)	7" (178mm)	Dry-Red	RC-5100DR	7.5" (191mm)	5" (127mm)	6" (152mm)	Dry-Blue	RF-1036DL
6" (152mm)	5" (127mm)	7" (178mm)	Dry-Yellow	RC-5100DY	7.5" (191mm)	5" (127mm)	6" (152mm)	Dry-Yellow	RF-1036DY
6" (152mm)	4.5" (114mm)	7" (178mm)	Dry-Black	RF-1015DK	7.5" (191mm)	4.5" (114mm)	6" (152mm)	Dry-Black	RF-1048DK
6" (152mm)	4.5" (114mm)	7" (178mm)	Dry-Blue	RF-1015DL	7.5" (191mm)	4.5" (114mm)	6" (152mm)	Dry-Blue	RF-1048DL
6" (152mm)	4.5" (114mm)	7" (178mm)	Dry-Red	RF-1015DR	7.5" (191mm)	4.5" (114mm)	6" (152mm)	Dry-Red	RF-1048DR
6" (152mm)	4.5" (114mm)	7" (178mm)	Dry-Yellow	RF-1015DY	7.5" (191mm)	4.5" (114mm)	6" (152mm)	Dry-Yellow	RF-1048DY
6" (152mm)	4.5" (114mm)	8" (203mm)	Dry-Black	RC-5106DK	7.5" (191mm)	4.5" (114mm)	6.5" (165mm)	Dry-Black	RC-5107DK
6" (152mm)	4.5" (114mm)	8" (203mm)	Dry-Blue	RC-5106DL	7.5" (191mm)	4.5" (114mm)	6.5" (165mm)	Dry-Blue	RC-5107DL
6" (152mm)	4.5" (114mm)	8" (203mm)	Dry-Red	RC-5106DR	7.5" (191mm)	4.5" (114mm)	6.5" (165mm)	Dry-Red	RC-5107DR
6" (152mm)	4.5" (114mm)	8" (203mm)	Dry-Yellow	RC-5106DY	7.5" (191mm)	4.5" (114mm)	6.5" (165mm)	Dry-Yellow	RC-5107DY

AMERICAN V-TWIN

STREET

OFF-ROAD

WATERCRAFT/SNOW

SPECIALTY/ACCESSORIES

HAULER HORSEPOWER

APPAREL/SIGNAGE

K&N® PRODUCT LISTINGS

# AIR FILTER WRAPS

## FOR ADDED PROTECTION

### DRYCHARGER® AND PRECHARGER® WRAPS - ROUND TAPERED CONTINUED

BASE I.D.	TOP I.D.	HEIGHT	DESC.	PART#
7.5" (191mm)	5.875" (149mm)	6.5" (165mm)	Dry-Black	<b>RF-1014DK</b>
7.5" (191mm)	5.875" (149mm)	6.5" (165mm)	Dry-Blue	<b>RF-1014DL</b>
7.5" (191mm)	5.875" (149mm)	6.5" (165mm)	Dry-Red	<b>RF-1014DR</b>
7.5" (191mm)	5.875" (149mm)	6.5" (165mm)	Dry-Yellow	<b>RF-1014DY</b>
7.5" (191mm)	5" (127mm)	6.5" (165mm)	Dry-Black	<b>RF-1042DK</b>
7.5" (191mm)	5" (127mm)	6.5" (165mm)	Dry-Blue	<b>RF-1042DL</b>
7.5" (191mm)	5" (127mm)	6.5" (165mm)	Dry-Red	<b>RF-1042DR</b>
7.5" (191mm)	5" (127mm)	6.5" (165mm)	Dry-Yellow	<b>RF-1042DY</b>
7.5" (191mm)	5.125" (130mm)	7" (178mm)	Dry-Black	<b>RF-1029DK</b>
7.5" (191mm)	5.125" (130mm)	7" (178mm)	Dry-Blue	<b>RF-1029DL</b>
7.5" (191mm)	5.125" (130mm)	7" (178mm)	Dry-Red	<b>RF-1029DR</b>
7.5" (191mm)	5.125" (130mm)	7" (178mm)	Dry-Yellow	<b>RF-1029DY</b>
7.5" (191mm)	5" (127mm)	7.5" (191mm)	Dry-Black	<b>RF-1041DK</b>
7.5" (191mm)	5" (127mm)	7.5" (191mm)	Dry-Blue	<b>RF-1041DL</b>
7.5" (191mm)	5" (127mm)	7.5" (191mm)	Dry-Red	<b>RF-1041DR</b>
7.5" (191mm)	5" (127mm)	7.5" (191mm)	Dry-Yellow	<b>RF-1041DY</b>
7.5" (191mm)	5" (127mm)	8" (203mm)	Dry-Black	<b>22-8038DK</b>

BASE I.D.	TOP I.D.	HEIGHT	DESC.	PART#
7.5" (191mm)	7" (178mm)	8" (203mm)	Dry-Black	<b>RF-1017DK</b>
7.5" (191mm)	7" (178mm)	8" (203mm)	Dry-Blue	<b>RF-1017DL</b>
7.5" (191mm)	7" (178mm)	8" (203mm)	Dry-Red	<b>RF-1017DR</b>
7.5" (191mm)	7" (178mm)	8" (203mm)	Dry-Yellow	<b>RF-1017DY</b>
7.5" (191mm)	5" (127mm)	8" (203mm)	Dry-Black	<b>RF-1020DK</b>
7.5" (191mm)	5" (127mm)	8" (203mm)	Dry-Red	<b>RF-1020DR</b>
7.5" (191mm)	5.875" (149mm)	8.5" (216mm)	Dry-Blue	<b>RF-1020DL</b>
7.5" (191mm)	5.875" (149mm)	8.5" (216mm)	Dry-Yellow	<b>RF-1020DY</b>
7.5" (191mm)	4.5" (114mm)	9" (229mm)	Dry-Black	<b>RC-5046DK</b>
7.5" (191mm)	4.5" (114mm)	9" (229mm)	Dry-Blue	<b>RC-5046DL</b>
7.5" (191mm)	4.5" (114mm)	9" (229mm)	Dry-Red	<b>RC-5046DR</b>
7.5" (191mm)	4.5" (114mm)	9" (229mm)	Dry-Yellow	<b>RC-5046DY</b>
7.5" (191mm)	5" (127mm)	4" (102mm)	Pre-Black	<b>22-8036PK</b>
7.5" (191mm)	7" (178mm)	8" (203mm)	Pre-Black	<b>22-8050PK</b>
8" (203mm)	6.625" (168mm)	10.5" (267mm)	Dry-Black	<b>RC-5166DK</b>
8" (203mm)	7" (178mm)	13" (330mm)	Dry-Black	<b>RC-5165DK</b>
8" (203mm)	6.625" (168mm)	8" (203mm)	Dry-Black	<b>RC-5112DK</b>

### DRYCHARGER® AND PRECHARGER® WRAPS - OVAL TAPERED

BASE" SIDE LENGTH	BASE" SIDE WIDTH	TOP" SIDE LENGTH	TOP" SIDE WIDTH	HEIGHT	DESC.	PART#
3" (76mm)	3.75" (95mm)	3" (76mm)	2" (51mm)	6" (152mm)	Dry-Black	<b>RC-3680DK</b>
4" (102mm)	3" (76mm)	3" (76mm)	2" (51mm)	2.75" (70mm)	Dry-Black	<b>RC-1820DK</b>
4" (102mm)	3" (76mm)	3.5" (89mm)	2.5" (64mm)	2.75" (70mm)	Dry-Black	<b>RU-0981DK</b>
4" (102mm)	3" (76mm)	3" (76mm)	2" (51mm)	4" (102mm)	Dry-Black	<b>RC-2890DK</b>
4" (102mm)	3.25" (83mm)	3.5" (89mm)	2.5" (64mm)	7" (178mm)	Dry-Black	<b>SN-2560DK</b>
4.5" (114mm)	3.75" (95mm)	3.5" (89mm)	2.5" (64mm)	2.75" (70mm)	Dry-Black	<b>RU-2780DK</b>
5.625" (143mm)	4.125" (105mm)	4.5" (114mm)	3.25" (83mm)	2.5" (64mm)	Pre-Blue	<b>KA-6589PL</b>
6" (152mm)	3.75" (95mm)	4.25" (108mm)	3.25" (83mm)	5" (127mm)	Pre-Black	<b>RU-4720PK</b>
6.25" (159mm)	3.75" (95mm)	4.5" (114mm)	3.5" (89mm)	6.75" (171mm)	Pre-Black	<b>RU-4710PK</b>
6.375" (162mm)	4.75" (121mm)	4.5" (114mm)	3.25" (83mm)	2.75" (70mm)	Pre-Black	<b>YA-2088PK</b>
6.5" (165mm)	4.5" (114mm)	9" (229mm)	5.5" (140mm)	6.25" (159mm)	Pre-Black	<b>RD-4200PK</b>
6.5" (165mm)	4.5" (114mm)	9" (229mm)	5.5" (140mm)	6.25" (159mm)	Pre-Blue	<b>RD-4200PL</b>
6.5" (165mm)	4.5" (114mm)	9" (229mm)	5.5" (140mm)	6.25" (159mm)	Pre-Red	<b>RD-4200PR</b>
6.5" (165mm)	4.5" (114mm)	9" (229mm)	5.5" (140mm)	6.25" (159mm)	Pre-Yellow	<b>RD-4200PY</b>
7" (178mm)	4.5" (114mm)	6.25" (159mm)	4" (102mm)	3" (76mm)	Dry-Blue	<b>22-2015PL</b>
7" (178mm)	4.5" (114mm)	6.25" (159mm)	4" (102mm)	3" (76mm)	Dry-Red	<b>22-2015PR</b>
7" (178mm)	5.5" (140mm)	5.25" (133mm)	4.25" (108mm)	5" (127mm)	Dry-Black	<b>RC-70031DK</b>
7.75" (197mm)	5.5" (140mm)	6.25" (159mm)	4" (102mm)	5" (127mm)	Dry-Black	<b>RF-1001DK</b>
7.75" (197mm)	5.5" (140mm)	6.25" (159mm)	4" (102mm)	5" (127mm)	Dry-Blue	<b>RF-1001DL</b>
7.75" (197mm)	5.5" (140mm)	6.25" (159mm)	4" (102mm)	5" (127mm)	Dry-Red	<b>RF-1001DR</b>
7.75" (197mm)	5.5" (140mm)	6.25" (159mm)	4" (102mm)	5" (127mm)	Dry-Yellow	<b>RF-1001DY</b>

### DRYCHARGER® AND PRECHARGER® WRAPS - OVAL STRAIGHT

INSIDE LENGTH	INSIDE WIDTH	HEIGHT	DESC.	PART#	INSIDE LENGTH	INSIDE WIDTH	HEIGHT	DESC.	PART#
4" (102mm)	3" (76mm)	2" (51mm)	Dry-Black	<b>E-4515DK</b>	7" (178mm)	4.5" (114mm)	2" (51mm)	Pre-Blue	<b>E-3321PL</b>
4" (102mm)	3" (76mm)	2.75" (70mm)	Dry-Black	<b>E-4516DK</b>	7" (178mm)	4.5" (114mm)	2" (51mm)	Pre-Red	<b>E-3321PR</b>
4.5" (114mm)	3.75" (95mm)	6" (152mm)	Pre-Black	<b>RU-1230PK</b>	7" (178mm)	4.5" (114mm)	2" (51mm)	Pre-Yellow	<b>E-3321PY</b>
4.5" (114mm)	3.75" (95mm)	7" (178mm)	Pre-Black	<b>RU-1240PK</b>	7" (178mm)	4.5" (114mm)	2.25" (57mm)	Pre-Black	<b>RK-3902PK</b>
4.5" (114mm)	3.75" (95mm)	9" (229mm)	Pre-Black	<b>RU-1260PK</b>	7" (178mm)	4.5" (114mm)	3.5" (89mm)	Pre-Black	<b>E-3341PK</b>
6.5" (165mm)	4.625" (117mm)	7.875" (200mm)	Dry-Black	<b>YA-7008DK</b>	7" (178mm)	4.5" (114mm)	3.5" (89mm)	Pre-Blue	<b>E-3341PL</b>
6.625" (168mm)	4.625" (117mm)	2.875" (73mm)	Pre-Yellow	<b>SU-6590PY</b>	7" (178mm)	4.5" (114mm)	3.5" (89mm)	Pre-Red	<b>E-3341PR</b>
6.625" (168mm)	3.813" (97mm)	3.438" (87mm)	Pre-Black	<b>PL-1002PK</b>	7" (178mm)	4.5" (114mm)	3.5" (89mm)	Pre-Yellow	<b>E-3341PY</b>
7" (178mm)	4.5" (114mm)	2" (51mm)	Dry-Blue	<b>22-2000PL</b>	7.375" (187mm)	4" (102mm)	2.063" (52mm)	Pre-Red	<b>HA-1312PR</b>
7" (178mm)	4.5" (114mm)	2" (51mm)	Dry-Red	<b>22-2000PR</b>	7.375" (187mm)	4" (102mm)	2.563" (65mm)	Pre-Red	<b>HA-1315PR</b>
7" (178mm)	4.5" (114mm)	3" (76mm)	Dry-Blue	<b>22-2020PL</b>	7.5" (191mm)	5.5" (140mm)	4.75" (121mm)	Dry-Black	<b>KA-7408DK</b>
7" (178mm)	4.5" (114mm)	3" (76mm)	Dry-Red	<b>22-2020PR</b>	7.75" (197mm)	4.75" (121mm)	2.5" (64mm)	Pre-Red	<b>HA-6592PR</b>
7" (178mm)	4.5" (114mm)	2" (51mm)	Pre-Black	<b>E-3321PK</b>	7.75" (197mm)	5.875" (149mm)	5.063" (129mm)	Pre-Black	<b>KA-7504PK</b>

# AIR FILTER WRAPS FOR ADDED PROTECTION

## DRYCHARGER® AND PRECHARGER® WRAPS - ROUND REVERSE TAPERED

BASE I.D.	TOP I.D.	HEIGHT	DESC.	PART#	BASE I.D.	TOP I.D.	HEIGHT	DESC.	PART#
3.375" (86mm)	3.5" (89mm)	4.125" (105mm)	Pre-Black	<b>SU-2504PK</b>	4.5" (114mm)	6" (152mm)	6.125" (156mm)	Dry-Black	<b>RX-3810DK</b>
3.813" (97mm)	3.875" (98mm)	8.125" (206mm)	Pre-Black	<b>YA-6504PK</b>	4.5" (114mm)	6" (152mm)	6.125" (156mm)	Dry-Red	<b>RX-3810DR</b>
4.5" (114mm)	6" (152mm)	6.125" (156mm)	Dry-Black	<b>RX-3810DK</b>	6.25" (159mm)	7" (178mm)	3.625" (92mm)	Dry-Black	<b>HD-0700DK</b>

## DRYCHARGER® AND PRECHARGER® WRAPS - UNIQUE SHAPES

DESCRIPTION	PART#	DESCRIPTION	PART#
Dry-Black	<b>SU-6596DK</b>	Dry-Black	<b>KT-5201DK</b>
Dry-Black	<b>HA-2591DK</b>	Dry-Black	<b>RC-5052DK</b>
Dry-Black	<b>HA-4503DK</b>	Dry-Black	<b>YA-4098-1DK</b>
Dry-Black	<b>KA-4408DK</b>	Dry-Black	<b>YA-4503DK</b>
Pre-Black	<b>KA-6503PK</b>	Dry-Black	<b>YA-6601DK</b>

## DRYCHARGER® AND PRECHARGER® WRAPS - UNIVERSAL USE

LENGTH	WIDTH	DESC.	PART#	LENGTH	WIDTH	DESC.	PART#
7" (178mm)	7" (178mm)	Dry-Black	<b>SU-4002-TDK</b>	9.75" (248mm)	5.75" (146mm)	Dry-Black	<b>YA-3502-TDK</b>
7.125" (181mm)	7.125" (181mm)	Dry-Black	<b>YA-4504-TDK</b>	9.875" (251mm)	7.125" (181mm)	Dry-Black	<b>HA-4504-TDK</b>
8.25" (210mm)	6.75" (171mm)	Dry-Black	<b>HA-4099-TDK</b>	10.25" (260mm)	6.875" (175mm)	Dry-Black	<b>YA-6601-TDK</b>
8.25" (210mm)	6.75" (171mm)	Pre-Black	<b>HA-4099-TPK</b>	58" (1473mm)	36" (914mm)	Dry-Black	<b>25-3901</b>

## PRE-CLEANER WRAPS

### ROUND TAPERED

DESCRIPTION	BASE I.D.	TOP I.D.	HEIGHT	PART#
Pre-Cleaner-Yellow	3.125" (79 mm)	3" (76 mm)	3.375" (86 mm)	<b>25-2588</b>
Pre-Cleaner-Red	6" (152 mm)	5" (127 mm)	14" (356 mm)	<b>25-0880</b>
Pre-Cleaner-Red	6" (152 mm)	5" (127 mm)	9" (229 mm)	<b>25-0810</b>
Pre-Cleaner-Red	7" (178 mm)	4.5" (114 mm)	4.875" (124 mm)	<b>25-6601</b>
Pre-Cleaner-Charcoal-Dry	8" (203 mm)	6.625" (168 mm)	12" (305 mm)	<b>25-5166</b>

PART NUMBER  
25-1691



### OVAL STRAIGHT

DESCRIPTION	INSIDE LENGTH	INSIDE WIDTH	HEIGHT	PART#
Pre-Cleaner-Red	4.5" (114 mm)	3.25" (83 mm)	1.5" (38 mm)	<b>25-4250</b>
Pre-Cleaner-Red	5.5" (140 mm)	4.25" (108 mm)	2" (51 mm)	<b>25-1691</b>
Pre-Cleaner-Red	7" (178 mm)	4.5" (114 mm)	3.25" (83 mm)	<b>25-3340</b>
Pre-Cleaner-Red	7" (178 mm)	4.5" (114 mm)	6" (152 mm)	<b>25-3346</b>

### UNIQUE

DESCRIPTION	PART#
Pre-Cleaner-Red	<b>25-2587</b>

### UNIVERSAL

DESCRIPTION	WIDTH	LENGTH	PART#
Pre-Cleaner-Red	7" (178 mm)	48" (1219 mm)	<b>25-3900</b>
Pre-Cleaner-Red	18" (457 mm)	48" (1219 mm)	<b>25-3918</b>
Pre-Cleaner-Red	24" (610 mm)	48" (1219 mm)	<b>25-3924</b>
Pre-Cleaner-Red	30" (762 mm)	48" (1219 mm)	<b>25-3930</b>

PART NUMBER  
25-3900



# K&N® WARRANTY INFORMATION

## CUSTOMER PROTECTION

### CONSUMER PROTECTION PLEDGE

We want to make sure that when you buy a K&N® lifetime air filter or air intake system, you can be confident your vehicle's warranty will not be impacted. We also want you to feel confident that even if you experience difficulties with a dealership repair department, we will step in and resolve the issue, so you won't have to. Therefore, we make the following Pledge:

**K&N® pledges to our customers that they will not be taken advantage of and charged for a repair due to a manufacturer warranty denial blamed on the presence of a K&N® product.**

### 10-YEAR/MILLION MILE LIMITED WARRANTY

K&N O/E Replacement Air Filters and Air Intake Systems purchased from Authorized Dealers are backed by a 10-year/million mile limited warranty when used primarily on paved roads and on vehicles for which they were designed. If one of these products ever fails to provide complete satisfaction, K&N will replace it.

#### WHAT IS NOT COVERED BY OUR WARRANTY

Any K&N product used for 1: any type of racing or competition; 2: any off-road use, custom or modified applications; 3: any off-road or dual sport motorcycle/ATV use; or 4: any illegal highway use, marine, or industrial applications. All K&N Air Filters not covered by our 10-year/million mile limited warranty are warranted against defective materials or workmanship for one year from date of purchase with no mileage limitation. This includes K&N Air Filters sold for ATV's and off-highway or dual-purpose motorcycles.

#### INCORRECT CLEANING OR USE VOIDS WARRANTY

K&N Air Filters should be cleaned every 50,000 miles for normal highway use, more often in dusty conditions. Cleaning should be done with K&N cleaner and air filter oil (or comparable air filter cleaner and oil). Use of compressed air, or chemicals not specifically designed to clean and re-oil cotton air filters (i.e. gasoline, transmission fluid, motor oil, lightweight oil, or diesel fuel) will void the warranty. Any damaged, abused or modified K&N Air Filters will not be warranted.

#### REPLACEMENT

Any K&N product returned to K&N will need a Return Goods Authorization number and must be sent at customers' expense along with proof of purchase. Call 1-800-858-3333 or contact K&N by email or mail.

#### PRODUCT REGISTRATION

Register your warranty at our web site and you'll be eligible for special promotions and product upgrade opportunities.

#### EXTENT OF WARRANTY

Any defective K&N Air Filter properly returned to K&N will be replaced. K&N reserves the right to determine whether the terms of the warranty, set out above, have been properly complied with. In the event that the terms are not complied with, K&N shall be under no obligation to honor this warranty. K&N will not be responsible for any indirect, consequential, special, contingent, or other damages.

### K&N® OIL FILTER WARRANTY

K&N oil filters are warranted to be free from defects in material and workmanship. Any filter proven defective during the engine or equipment manufacturer's or during the oil supplier's recommended service intervals will be replaced at no charge.

In the event of an engine or equipment failure directly caused by a defective K&N oil filter, which was properly installed and changed following the engine or equipment manufacturer's recommended service intervals, K&N Engineering, Inc. will repair the damaged engine or equipment. If a full synthetic or other premium lubricant is used K&N will extend this coverage to the interval specified by the lubricant supplier.

Claims for engine or equipment repairs provided under this warranty must be submitted within 30 days after discovery of damage. K&N Engineering, Inc. reserves the right to examine the engine or equipment and filter to determine the amount of damage and whether it was caused by a defective K&N oil filter.

This warranty gives you specific legal rights. You may have other rights which vary from state to state.

Engine and equipment manufacturer's warranties remain in effect when K&N oil filters are used.



### COMMERCIAL GRADE DIESEL AIR FILTER WARRANTY

K&N commercial grade air filters have a 3-year or 300,000-mile limited warranty. They are meant to be washed and reused multiple times before needing to be replaced.

### ENGINE PROTECTION LIMITED WARRANTY

Unlike many companies, our warranty for O/E replacement air filters and intake systems does extend beyond the replacement of a defective K&N part. For the original purchaser of the product, our warranty covers any engine damage or related costs incurred as a direct result of the use of a properly installed and maintained K&N O/E replacement air filter or intake system on the specific vehicle for which the product was designed to be used by K&N. This includes reasonable vehicle repair costs, sensor replacements, car rental fees or other incidental expenses directly related to an engine problem caused by the failure of a K&N product. Furthermore, we warrant that using our product will not result in a vehicle warranty denial. K&N will not be responsible for any indirect, consequential, special, contingent, or other damages not listed above.

We will promptly reimburse the consumer for the cost of the repair if a service provider denies warranty coverage as a result of a K&N product or claims that a K&N product has caused harm to your engine or vehicle. In order to receive reimbursement, we require each of the following:

1. The consumer must provide a written statement or repair order from the dealership or service provider in which the dealership or service provider blames the problem or warranty denial on a K&N product;
2. The service provider or consumer must provide K&N with all allegedly damaged parts. Many states have laws that require a service provider to retain all parts replaced during a vehicle repair, unless given consent to dispose of the parts by the consumer. K&N will pay the shipping cost to recover these parts; and
3. The consumer must provide proof of purchase of the K&N product along with cooperation in helping us investigate the claim.

Once these steps have been completed, K&N will contact the service provider and collect evidence to support their claim. In the event we are not provided with sufficient evidence, we reserve the right to reject the claim and will use our best efforts to assist in establishing your rights toward the service provider under warranty or other provisions.

**We strive to exceed consumer expectations. Customer service can be reached at 1-800-858-3333.**



# K&N® WARRANTY INFORMATION

## CUSTOMER PROTECTION

### EMISSIONS STANDARDS AND SMOG TEST REQUIREMENTS

K&N offers more 50-state street legal automotive intake systems than any other company. Check the status of the part number for your vehicle in this catalog or on our website and check whether it has a CARB E.O. CARB stands for California Air Resources Board.

In order for an intake system to be legal in California and states with emission standards, the part must receive an exemption in the form of an E.O. number from CARB which is only valid for a specific vehicle and the E.O. must be in or attached to the vehicle. That means a part number can be CARB exempt for some vehicle applications and not others. There is no such thing as "CARB pending". A particular part number on a particular vehicle is either exempt or not. An intake system that does not have a CARB E.O. is not legal for highway use in California and a few other states and will not pass a state regulated emissions test solely due to the absence of an E.O. number. If you still have questions about the legality of a K&N part number on your vehicle, please visit our website or contact customer service at 1-800-858-3333. You can also determine whether CARB exemption is required for a part on your vehicle to be legal in your state by checking with your local or state motor vehicle or emissions agency.

### HORSEPOWER GUARANTEE

#### K&N® AIR INTAKE SYSTEMS ARE GUARANTEED TO INCREASE POWER!

*(Applicable only for Air Intake Systems purchased and installed in the U.S.A.)*

Every K&N air intake system we design has been tested on a chassis dynamometer to establish that it will provide an increase in horsepower to the drive wheels of the vehicle.\* We publish estimated horsepower increases to allow consumers an opportunity to view a real test result for a specific or similar vehicle even though the actual results a consumer will receive will vary depending on such things as the condition of the vehicle, weather, fuel, and other circumstances.

Our horsepower guarantee is simple and straightforward. If you are the original retail purchaser of a K&N intake system, we offer an unconditional 30 day money back guarantee. If you are unhappy with a K&N intake system for any reason, including the horsepower improvement experienced, we will refund 100% of the purchase price and even pay for return shipping to K&N.

If you are not completely satisfied and wish to return your intake, simply call our customer support team in Riverside, California at 800-858-3333 within 30 days of the original purchase. Provide your name, address, contact information, and original purchase price. We will issue a return authorization number to you. We can also send you a shipping label to get the intake returned at no cost to you. Then use the shipping label to return the complete air intake system (including all parts and components) in an undamaged condition (exclusive of ordinary wear and tear and markings from installation) in the original packaging, together with the original proof of purchase, clearly showing the date of purchase and amount paid. Make sure that the shipping label clearly indicates the return authorization number. A check for the refund will be sent, within 30 days of receipt, to the name and address provided.

This guarantee does not apply to any other costs incurred by the original purchaser, including, but not limited to, dynamometer testing, parts and labor for the installation or removal of the air intake system, loss of use, or other incidental costs.

\* Please note that the horsepower rating that a motor vehicle manufacturer advertises is usually measured at the crankshaft of the engine using an engine dynamometer. There is generally a parasitic loss of horsepower between the crankshaft and drive wheels, which is caused by the drivetrain of the vehicle. This means we will often show absolute horsepower numbers that are lower than the vehicle manufacturer since we are measuring the horsepower that reaches the road.

### K&N® ESTIMATED HORSEPOWER GAINS

K&N provides estimated SAE corrected horsepower gains that are based on actual dynamometer testing for a specific or similar vehicle. The actual horsepower increase a consumer will receive will vary depending on such things as vehicle condition, fuel, weather and other circumstances. It would be impractical to test every possible vehicle configuration or year in which a particular engine may be used; therefore, many of our estimates are based upon similar engine/vehicle/year dynamometer testing that we believe to be representational for the vehicle listed.

### K&N® DYNAMOMETER TEST RESULTS

K&N utilizes an inertial dynamometer (dyno) to determine the estimated SAE corrected horsepower of our intakes kits and OE replacement air filters. This type of dyno does not actually measure horsepower, but rather measures acceleration. This measured acceleration is then multiplied by the mass of the drum (a constant mass) to obtain the force being applied to the drum, or in other words, the interface between the vehicle's tires and the dyno drum. Now that the force at this point is known, determining the torque is straightforward. The torque is calculated by multiplying the calculated force by the radius (again a constant) of the dyno's drum.

Now, torque is very simply and mathematically related to horsepower by the following equation:

$$\text{Horsepower} = \text{Torque} \times \text{RPM} / 5,252$$

From this equation, the SAE corrected horsepower can be determined.

According to the above explanation, the only variable being measured by the dyno is the acceleration of the drum. There are no adjustments (calibration) to be made by K&N on either the two-wheel or four-wheel drive dyno. The mass of the drum(s) is determined at the factory before shipping the dynamometers to K&N and the mass of the drum(s) are imbedded into the software. K&N does not have the ability to modify or adjust these values.

Furthermore, there are several factors that can affect the SAE corrected horsepower values as measured by K&N or at any other dyno facility. Some of these factors are:

- Consistency of test parameters
- Tire pressure
- Fuel octane rating
- Vehicle condition
- The atmospheric conditions (dyno correction factors can vary from engine electronic correction factors)

K&N has noticed that SAE corrected horsepower values will vary from day-to-day, while testing the same vehicle, due to the manner in which the vehicle's on-board computer adjusts for varying climate conditions. In other words, if a vehicle is tested at sea level on a sunny and warm day, the dyno will apply a SAE correction factor to adjust the conditions to a standard temperature and pressure (STP) and the vehicle's on-board computer will also apply certain set of operating parameters. If that same vehicle is tested at a high altitude, on a rainy and cold day, the dyno will again adjust to STP while the vehicle may adjust to a different correction factor than it did on the sea level test. Furthermore, some vehicles have required almost a 100 miles be logged on the vehicle in order to allow the on-board computer to reset itself to obtain accurate power readings.

While K&N pays close attention to these many factors, and is patient while performing dyno tests, we are not in the position to scrutinize the many facilities that perform dynamometer testing for the general public. Furthermore, we certainly do not have enough information to make a judgment on the validity of these tests.

# AIR FILTER CLEANING

## RECHARGE YOUR K&N® AIR FILTER

### SERVICING YOUR K&N® AIR FILTER IS SIMPLE - JUST FOLLOW THE 4 EASY STEPS BELOW

#### STEP 1: APPLY CLEANER

Liberally spray K&N® air filter cleaner or K&N® Power Kleen™ onto both sides of filter and allow to soak for 10 minutes to loosen the dirt. Do not allow cleaner to dry on air filter.



#### STEP 2: RINSE FILTER

Rinse off air filter with cool low-pressure water from the clean side out in order to flush the dirt out of the filter. Continue to rinse the filter until all traces of cleaner are gone. It may be necessary to repeat steps 1 and 2.



#### STEP 3: DRY FILTER

After rinsing, gently shake off excess water and allow filter to dry naturally. Do not oil until the filter is dry.

#### STEP 4: OIL FILTER

**SQUEEZE OIL (99-5050):** Apply K&N® air filter oil evenly along the crown of each filter pleat. Allow oil to wick for approximately 20 minutes. Touch up any light areas on either side of the filter until there is a uniform red color on all areas.



**AEROSOL OIL (99-5000):** Spray K&N® air filter oil evenly along the crown of each filter pleat holding nozzle about 3" away. Allow oil to wick for approximately 20 minutes. Touch up any light areas on either side of the filter until there is a uniform red color on all areas.



*The above process is the only approved procedure for maintaining your oiled cotton K&N® air filter. Visit [knfilters.com](http://knfilters.com) for additional information on cleaning and re-oiling your filter and examples of a dirty filter needing to be serviced.*

# CLEANING SUPPLIES

## RECHARGE YOUR K&N® AIR FILTER

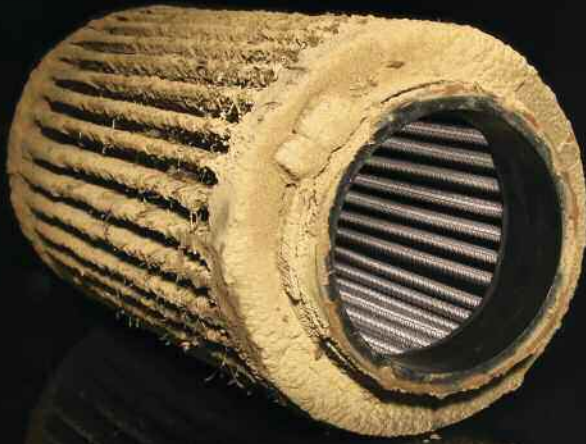

### K&N® POWER KLEEN® INDUSTRIAL STRENGTH CLEANER

	PART#
32 oz. trigger sprayer	99-0621
1 gallon bottle with trigger sprayer	99-0635
12 fl. oz. squirt bottle	99-0606
5 gallon pail	99-0640

### POWER KLEEN™ CLEANER/DEGREASER

K&N® Power Kleen® is the only cleaner recommended to clean K&N® air filter elements. The use of any other cleaning solution can void the filter's warranty, and quite possibly could damage your engine and the filter's cotton material. K&N® Power Kleen® works to dissolve dirt build up and old filter oil and can be washed away with water. It is now formulated to clean those troublesome and demanding cleaning jobs around your garage as well. It is environmentally friendly and specially formulated to remove oil, lubricants, grease, grime, and other deposits from most surfaces including cotton air filters, painted surfaces, chrome, plastic and more!



PART NUMBER  
99-0635

PART NUMBER  
99-0621



PART NUMBER  
99-0640



PART NUMBER  
99-5000



PART NUMBER  
99-5050



PART NUMBER  
99-0606



PART NUMBER  
99-0504



PART NUMBER  
99-0533

### RECHARGER® FILTER SERVICE KIT (AEROSOL)

Designed to recharge any K&N® oiled cotton air filter. It restores airflow efficiency so your air filter performs virtually like new!

6 1/2 oz. spray oil, 12 oz. filter cleaner and service decal **99-5000**

### DRYFLOW® AIR FILTER CLEANER

Specially formulated cleaner to be used on K&N® heavy duty commercial grade air filters and NEW Blackhawk Induction™ intake system air filters.

32 oz. trigger sprayer **99-0624**  
1 gallon bottle with 38-inch hose & spray nozzle **99-0638**

### FILTER SEALING GREASE

K&N® air filter sealing grease provides an air tight fit around sealing surfaces on all types of air filter elements. It resists heat and will not melt or run off. **(not to be used on clamp-on filter elements)**

6 oz. squeeze tube **99-0704**  
1 oz. squeeze tube **99-0703-1**

### RECHARGER® FILTER SERVICE KIT (SQUEEZE)

Same as 99-5000 except has squeeze oil bottle instead of spray can.

8 oz. squeeze oil, 12 oz. filter cleaner and service decal **99-5050**

### AIR FILTER OIL

K&N® air filter oil is the only oil specially formulated to work in combination with the cotton fabric in K&N® air filter elements providing outstanding air filtration. When used as directed, it quickly penetrates the filter pleats, where it remains suspended in the cotton fabric until the element is cleaned with K&N® air filter cleaner.

6 1/2 oz. aerosol can **99-0504**  
12 oz. aerosol can **99-0516**  
8 oz. squeeze bottle **99-0533**  
1/2 oz. pillow pack **99-11312**  
1 gallon refill bottle **99-0551**  
5 gallon pail **99-0555**

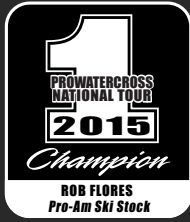
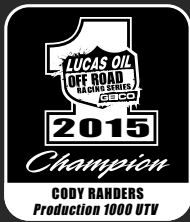

# SUPERIOR AIRFLOW.

# SUPERIOR PERFORMANCE.™

### CORPORATE HQ

K&N Engineering, Inc.  
1455 Citrus Street  
Riverside, CA 92507  
P.O. Box 1329  
Riverside, CA 92502-1329  
Phone: 1-800-858-3333  
Fax: 951-826-4001

### UK SALES

K&N Filters Ltd.  
John Street  
Warrington  
Cheshire, England  
WA2 7UB  
Phone: 44-1925-636-950  
Fax: 44-1925-418-948

### EUROPEAN OFFICE

SRM BV  
(Subsidiary of K&N Engineering, Inc.)  
Verdunplein 6  
5627 SZ Eindhoven  
The Netherlands  
Phone: 31 (0) 40-256-8678  
Fax: 31 (0) 40-256-7687

Follow us @knfilters



## KNFILTERS.COM